
 PETRONAS	ADDITIONAL INFORMATION TO THE DEIA REFINERY AND PETROCHEMICAL INTEGRATED DEVELOPMENT (RAPID) PROJECT, PENGERANG JOHOR, 2012 TO INCLUDE EURO 5 MOGAS AND OLEFIN TANK UNITS	 INTEGRATED ENVIROTECH
	CHAPTER 1 INTRODUCTION	

1 INTRODUCTION

1.1 Project Title

The title of this report is “**Additional Information to the DEIA for Refinery and Petrochemical Integrated Development (RAPID) Project, Pengerang Johor, 2012 to include EURO 5 MOGAS and Olefin Tank Units**”.

1.2 Project Proponent



The Project Proponent is **PRPC Refinery Cracker (RC) Sdn Bhd**. Details pertaining to the Project Proponent are as follow:

PRPC Refinery Cracker (RC) Sdn Bhd
 Level 62, Vista Tower,
 The Intermark,
 348 Jalan Tun Razak,
 50400 Kuala Lumpur.

Company representative : Ir. Dr. Colin Wong Hee Huing
 Designation : Director, PRPC Refinery Cracker (RC) Sdn Bhd
 Telephone : (+603) 2858 3322
 Facsimile : (+603) 2858 2111
 Email Address : colinwh@petronas.com.my

All correspondence shall be addressed to:

Contact person : Musa bin Mohammad
 Designation : Project Director (Refinery and Cracker)
 Telephone : (+603) 2858 2194
 Facsimile : (+603) 2858 2101
 Email Address : musam@petronas.com.my

 PETRONAS	ADDITIONAL INFORMATION TO THE DEIA REFINERY AND PETROCHEMICAL INTEGRATED DEVELOPMENT (RAPID) PROJECT, Pengerang Johor, 2012 TO INCLUDE EURO 5 MOGAS AND OLEFIN TANK UNITS	 INTEGRATED ENVIROTECH
	CHAPTER 1 INTRODUCTION	

1.3 EIA Study Consultant

Integrated Envirotech Sdn. Bhd. (IESB) has been appointed as the lead Environmental Consultant to prepare and submit this report. Enquiries and correspondence pertaining to this report can be made to:-

Integrated Envirotech Sdn. Bhd. (650387-K)
 No. 32-2, Jalan Setiawangsa 11A
 Taman Setiawangsa
 54200 Kuala Lumpur.

Contact Person: Dr. Mohd Zaki Bin Dato Mohd Said
 Telephone: (+603) 4256 6623
 Facsimile: (+603) 4251 9623
 Email: drzaki@envirotech.com.my

1.4 Legal Requirement



The Detailed Environmental Impact Assessment (DEIA) for the Proposed Refinery and Petrochemical Integrated Development (RAPID) Project, Pengerang Johor (herein will be referred as **RAPID DEIA 2012**) had been approved by the Department of Environment (DOE), Putrajaya on the 27th August 2012.

In June 2016, the Project Proponent initiated the followings:

- a) Addition of process units for the production of MOGAS that meet EURO 5 specification in the current RAPID Refinery and Cracker Complex
- b) Addition of 9 number of Olefin Tanks to accommodate the storage of Ethylene, Propylene and Butadiene in the current Refinery tank farm area located within the Refinery and Cracker Complex.

In reference to the RAPID DEIA 2012 approval letter issued by DOE Putrajaya on 27th August 2012, Ref. No.: AS (PN) 35/400/000/058), Approval Conditions No 79 states the followings :

“ Pemaju projek hendaklah memaklumkan secara bertulis dan mendapat kelulusan Jabatan Alam Sekitar jika terdapat sebarang pertukaran hak milik

 PETRONAS	ADDITIONAL INFORMATION TO THE DEIA REFINERY AND PETROCHEMICAL INTEGRATED DEVELOPMENT (RAPID) PROJECT, PENERANG JOHOR, 2012 TO INCLUDE EURO 5 MOGAS AND OLEFIN TANK UNITS	 INTEGRATED ENVIROTECH
	CHAPTER 1 INTRODUCTION	

atau pengurusan projek dalam tempoh 30 hari dari tarikh pertukaran hak milik atau pengurusan. Sebarang pertukaran hak milik atau pembahagian hak milik atau pengurusan hendaklah memasukkan kehendak mematuhi syarat-syarat kelulusan Laporan EIA terperinci kepada pemilik baru dalam transaksi jual beli/ pertukran hak milik tersebut. ”

The approval conditions requires Project Proponent to notify in writing and obtain approval from Department of Environment if there is any transfer or change of ownership or the management of the proposed project within 30 days from the date of the change or transfer of ownership or change in management of the project. The requirements to comply to the DEIA Conditions of Approval by the new owner is to be included in the transaction of the change/transfer of ownership or change in the project management.

Subsequently, discussion with DOE was held on 19th September 2016 confirmed on the requirement to prepare and submit an Additional Information Report to the approved RAPID DEIA 2012 for DOE approval.

1.5 Study Objectives

In order to support this report submission, a series of process related specialised studies need to be carried out to analyse the findings of the impact due to the aforementioned changes. The required studies to be conducted are;

- Air Dispersion Modelling;
- Noise Dissipation Study;
- Health Impact Assessment;
- Quantitative Risk Assessment (QRA);
- Waste Handling and Management; and
- Effluent Dispersion Modelling.

The above studies will be based on DOE’s requirements and conducted for the following modelling scenarios:

- Emission from each of the additional process units (i.e. EURO5 MOGAS unit and Olefin storage tanks);

- Cumulative emission from the units in the Refinery and Cracker Complex
- Cumulative emission from the RAPID Complex.

This report will also include the details of the process description of the additional process or units to Refinery and Cracker Complex from that in the approved RAPID DEIA in 2012.

1.6 RAPID Refinery and Cracker Complex

Currently all of the process units in the RAPID Refinery and Cracker Complex is at an advanced stage of detailed design. Currently, RAPID is designed to meet EURO 5 for Diesel and EURO 4M for MOGAS. In view of the MOGAS EURO 5 specification implementation, the modification of the RAPID's refinery configuration is essential to meet the requirement for the EURO 5 grade.

The new units to be included as part of the EURO 5 MOGAS are as in **Table 1.1**.

The location of the RAPID Complex and Location of the EURO 5 MOGAS Units and Olefin Storage Tanks is as indicated in **Figure 1.1**.

Table 1.1 RAPID EURO 5 MOGAS Units

UNIT	DESCRIPTION	CAPACITY (BPSD)
1410: Second Stage Hydrodesulphurization section (HDS2) of Cracked Naphtha Hydrotreating Unit	Designed to process blend of MCN and HCN from First Stage Hydrodesulphurization section of CNHT	43,000
1440: TAME Etherification Unit	Designed to process LCN in order to convert it into TAME (Tertiary-Amyl-Methyl-Ether) by Etherification with Methanol.	17,500
1450: Isomerization Unit	Designed to perform Isomerization of Hydrotreated Light Naphtha from NHT	10,000

*BPSD = Barrels per stream day

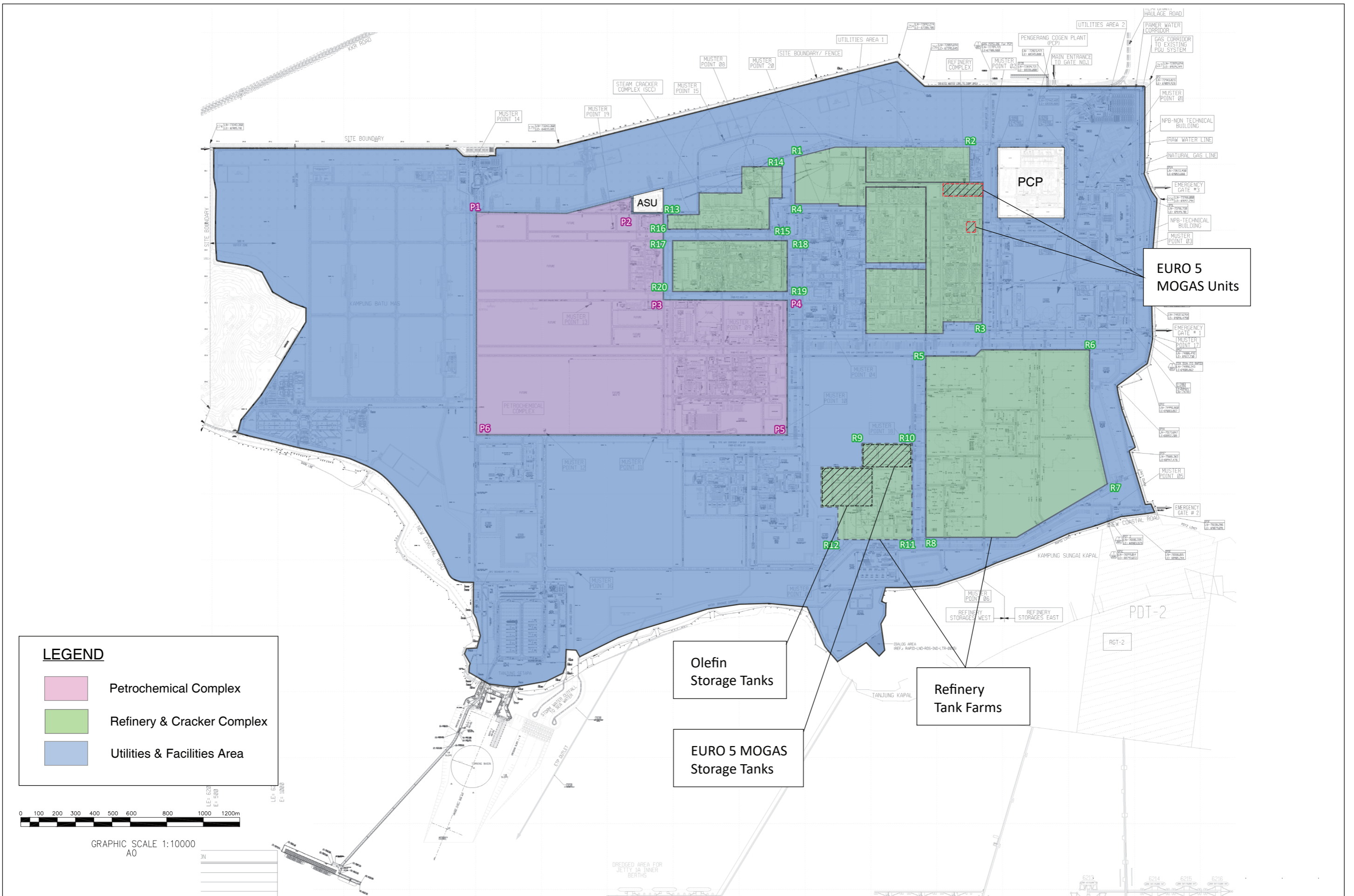


Figure 1.1 : RAPID Complex Plot Plan and Location of the EURO 5 MOGAS Units and Olefin Storage Tanks

The Project Proponent also intends to construct additional olefins storage facilities for optimization of the storage configuration due to the deletion of the Elastomer process units in the RAPID Petrochemical Complex. The additional olefin storage tanks are required due to the need for:

- Managing the inventory within RAPID for plant upsets or interruption and ensure continuous operation of the Refinery Cracker and/or Downstream Petrochemical plants;
- Maximising storage within the RAPID facilities & minimize storage at external facilities;
- Ensuring smooth loading directly from RAPID tankages into the vessel berthing at external facilities;

The current storage capacities of Ethylene, Propylene and Butadiene at the RAPID Refinery and Cracker are as in **Table 1.2**.

Table 1.2 Current Product Storage Capacities

No.	Product	Facility at RAPID	Facility at PDT-2	Export Volume (KTPA)
1	Ethylene	5 x 700MT Pressurized Spheres	1 x 8,000 MT Refrigerated Tank	112
2	Propylene	3 x 1,050MT Pressurized Spheres	1 x 10,000 MT Refrigerated Tank	375
3	Butadiene	2 x 1,600MT Bullets	4,358 MT Tank (Planned)	135

Additional storage capacities at the Olefin Storage Tanks are:

No.	Service	Unit	Total Capacity
1.	Ethylene	1 x 12,000 MT Refrigerated Tank and associated equipment and piping	12,000 MT
2.	Propylene	4 x 2,500 MT Spheres and associated equipment and piping	10,000 MT
3.	Butadiene	4 x 1,667 MT Bullets and associated equipment and piping	6,668 MT

The overall plot plan for location of additional storage facilities is as indicated in **Figure 1.2** and **Figure 1.3** below.

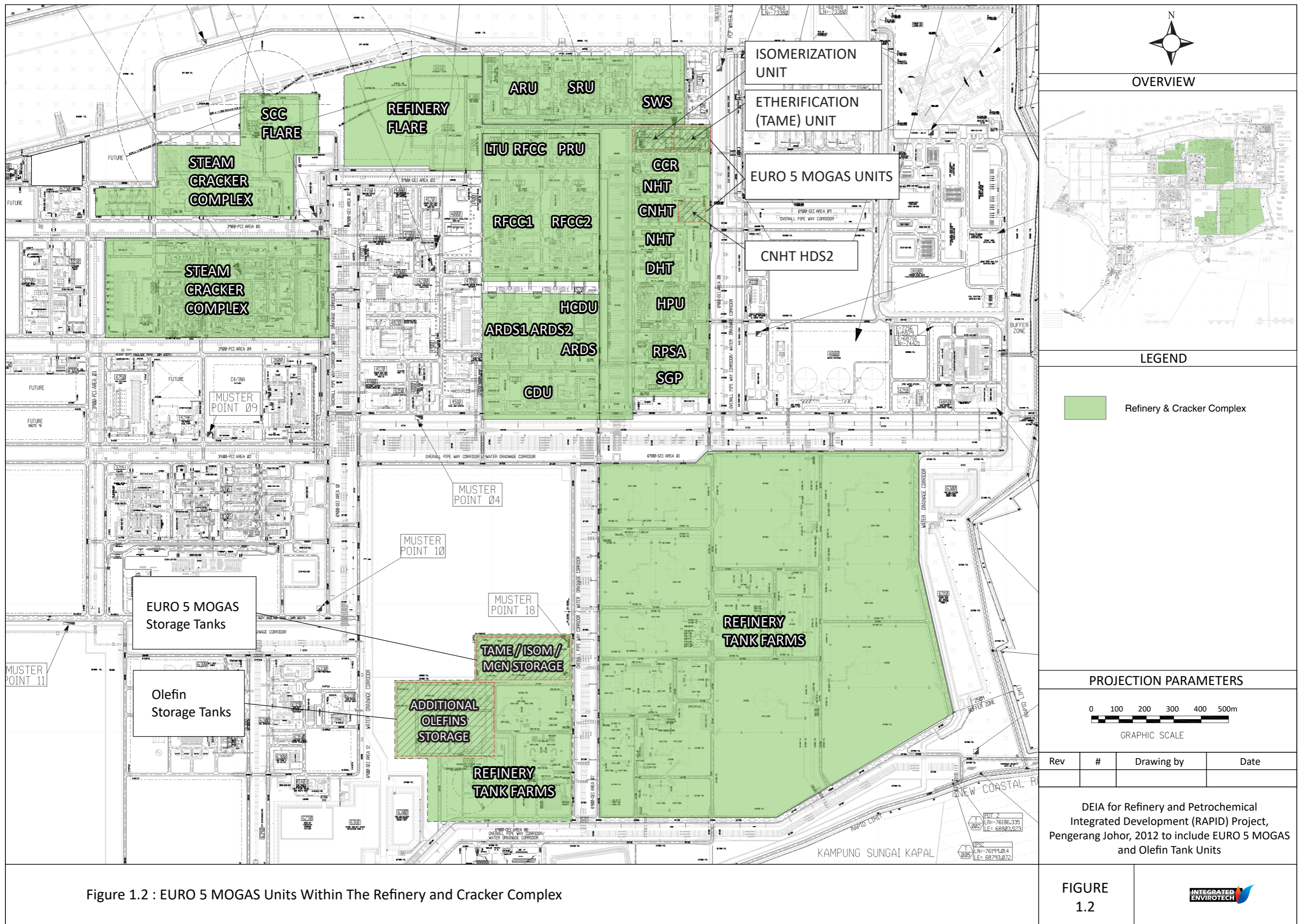


Figure 1.2 : EURO 5 MOGAS Units Within The Refinery and Cracker Complex

FIGURE 1.2



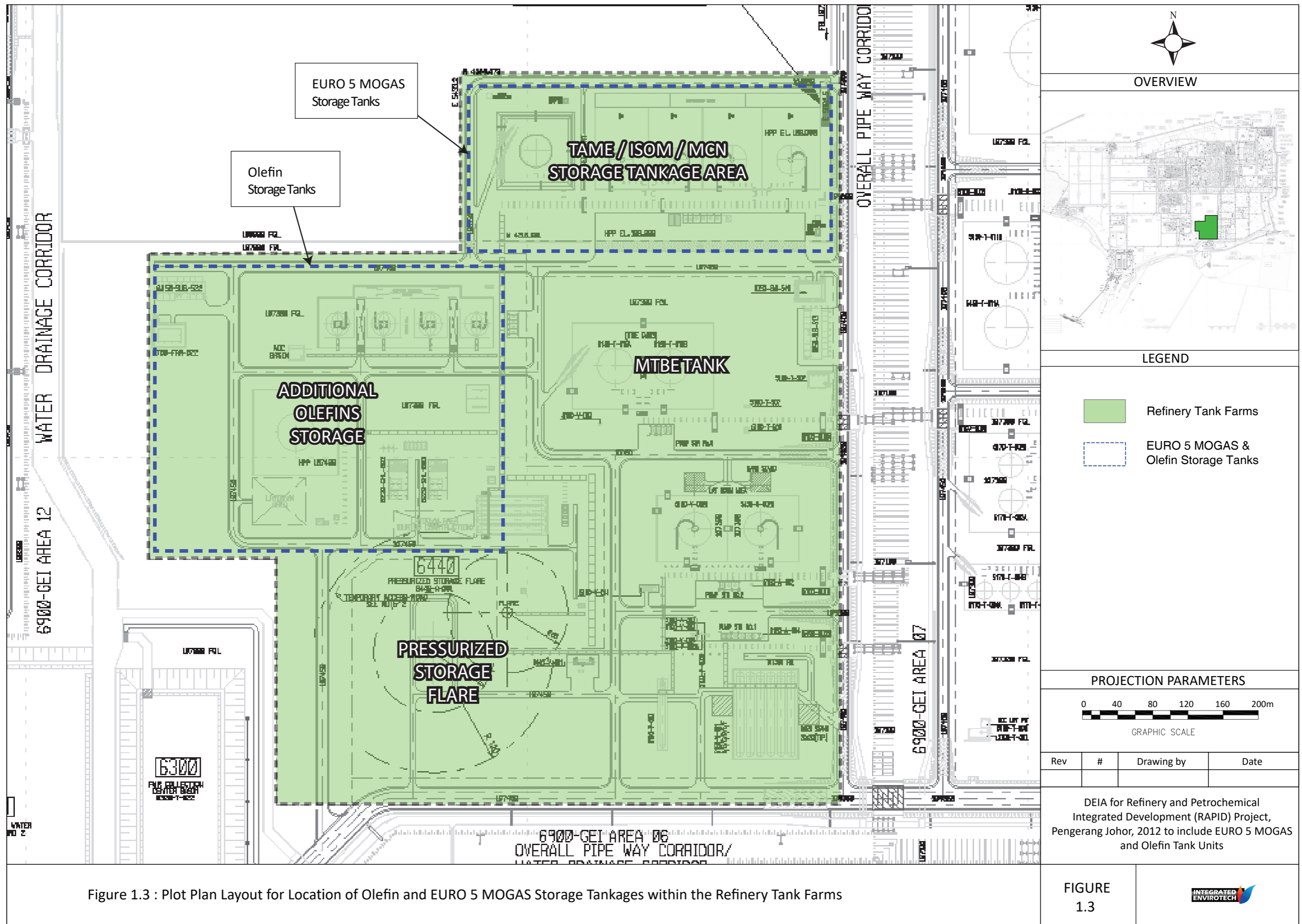


Figure 1.3 : Plot Plan Layout for Location of Olefin and EURO 5 MOGAS Storage Tankages within the Refinery Tank Farms

FIGURE 1.3



1.7 Project Location

The RAPID Refinery and Cracker Complex are located within the RAPID site in Pengerang, Johor (refer **Figure 1.4**). The longitude (E) and latitude (N) coordinates are tabulated inside **Figure 1.4** as well.

1.8 Report Structure

The format and structure of this Additional Information Report is as follows:

Chapter	Title
1	Introduction
2	Project Description
3	Approach and Methodology
4	Potential Environmental Impact and Mitigation Measures
5	Residual Impact
6	Environmental Management Plan
7	Emergency Response Plan
8	Conclusion

1.9 Team Members

The list of team members and subject specialist team involved in preparing this report are as listed in **Table 1.3** and **Table 1.4**.

LEGEND

- Petrochemical Complex
- Refinery and Cracker Complex
- Utilities & Facilities Area

Petrochemical Complex

ID	Latitude	Longitude
P1	1° 22' 27.5977" N	104° 08' 16.4435" E
P2	1° 22' 33.9117" N	104° 09' 02.0387" E
P3	1° 22' 08.6370" N	104° 09' 01.6591" E
P4	1° 22' 08.7027" N	104° 09' 31.5682" E
P5	1° 21' 33.3279" N	104° 09' 30.9673" E
P6	1° 21' 32.8795" N	104° 08' 15.4272" E

Refinery Cracker Complex

ID	Latitude	Longitude
R1	1° 22' 41.6812" N	104° 09' 34.4440" E
R2	1° 22' 44.6783" N	104° 10' 20.4065" E
R3	1° 22' 01.9084" N	104° 10' 19.1854" E
R4	1° 21' 58.9560" N	104° 09' 50.5437" E
R13	1° 22' 27.4470" N	104° 09' 02.9569" E
R14	1° 22' 39.3358" N	104° 09' 31.1505" E
R15	1° 22' 23.8683" N	104° 09' 28.3291" E
R16	1° 22' 23.9017" N	104° 09' 02.9777" E
R17	1° 22' 20.3897" N	104° 09' 04.7535" E
R18	1° 22' 20.8964" N	104° 09' 31.0758" E
R19	1° 22' 08.7027" N	104° 09' 31.5682" E
R20	1° 22' 09.2150" N	104° 09' 04.4880" E

Refinery Tank Farms

ID	Latitude	Longitude
R5	1° 21' 52.6608" N	104° 10' 04.9869" E
R6	1° 21' 54.2581" N	104° 10' 44.5088" E
R7	1° 21' 20.3618" N	104° 10' 49.5044" E
R8	1° 21' 06.9801" N	104° 10' 04.2359" E
R9	1° 21' 25.6967" N	104° 09' 38.0402" E
R10	1° 21' 31.3343" N	104° 10' 01.3419" E
R11	1° 21' 08.2204" N	104° 10' 01.1178" E
R12	1° 21' 08.1955" N	104° 09' 42.5843" E

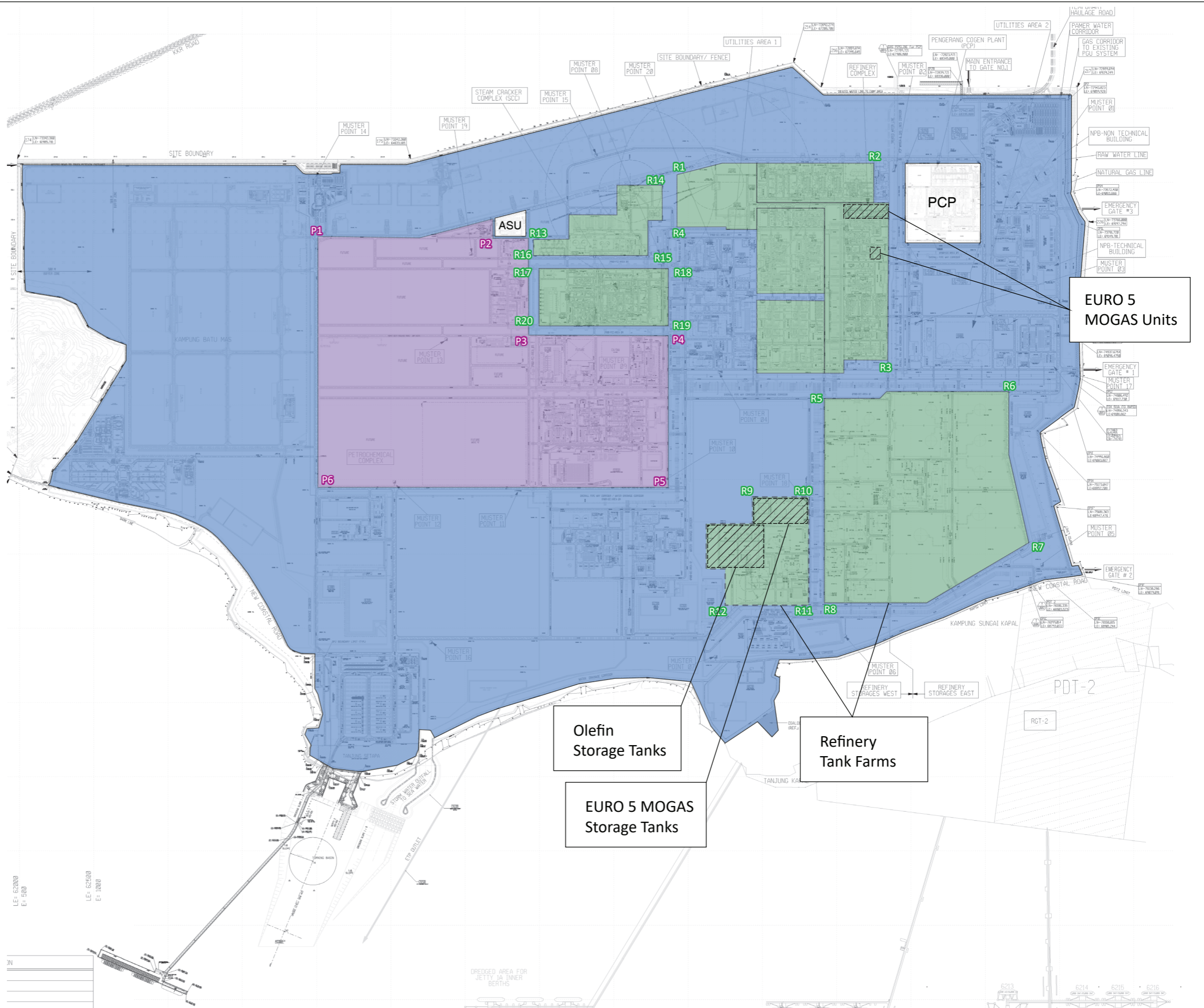




Figure 1.4 : RAPID Refinery and Cracker Complex within the RAPID Site and Location of the EURO 5 MOGAS and Olefin tankages

Table 1.3 List of EIA Study Team Members (Consultants)



No.	Name	Qualification	Registration with DOE				Proposed Study Area
			Category	Area / Field	ID No.	Valid Date	
EIA Study Team Leader							
1	Dr. Mohd Zaki Mohd Said	<ul style="list-style-type: none"> Dip, B S c, M Sc, PhD 	EIA Consultant	<ul style="list-style-type: none"> Fisheries Marine Biology Socio Impact Assessment Quantitative Risk Assessment 	C0277	31 st Mar 2019	<ul style="list-style-type: none"> Fisheries Marine Biology
EIA Study Team Member							
2	Lim Sze Fook	<ul style="list-style-type: none"> B.Sc (Hons) Physics 	EIA Consultant	<ul style="list-style-type: none"> Air Quality and Odour Meteorology 	C0282	31 st Decemer 2017	<ul style="list-style-type: none"> Air Quality and Odour Meteorology
3	Tan Poh Aun	<ul style="list-style-type: none"> M. Tech (Environmental Management) B. Sc (Chemistry) 	EIA Consultant	<ul style="list-style-type: none"> Air Quality and Odour Chemical Processes Water Quality General Environmental Management) 	C0104	1 st June 2017	<ul style="list-style-type: none"> Air Quality and Odour
7	Prof. Dr. Mohd. Salman Leong	<ul style="list-style-type: none"> PhD (Mechanical) B. Eng (Mechanical) 	Subject Consultant	<ul style="list-style-type: none"> Air Quality Noise Quality General Environmental Management 	SS0374	31 st July 2018	<ul style="list-style-type: none"> Noise Dissipation Modelling

	ADDITIONAL INFORMATION TO THE DEIA REFINERY AND PETROCHEMICAL INTEGRATED DEVELOPMENT (RAPID) PROJECT, PENGERANG JOHOR, 2012 TO INCLUDE EURO 5 MOGAS AND OLEFIN TANK UNITS	
	CHAPTER 1 INTRODUCTION	



No.	Name	Qualification	Registration with DOE				Proposed Study Area
			Category	Area / Field	ID No.	Valid Date	
8	Adnan Yusop Ali	<ul style="list-style-type: none"> B Eng (Chemical) 	Subject Consultant	<ul style="list-style-type: none"> Quantitative Risk Assessment 	SS0066	1 st June 2017	<ul style="list-style-type: none"> Quantitative Risk Assessment
9	Prof. Dr Jamal Hisham Hashim	<ul style="list-style-type: none"> PhD (Environmental Health Sciences) M Sc (Public Health) B Arts (Biology & Environmental Studies) 	Subject Consultant	<ul style="list-style-type: none"> Health Impact Assessment 	CS0484	10 th Dec 2017	<ul style="list-style-type: none"> Health Impact Assessment
10	Dr. Juan Carlos Savioli	<ul style="list-style-type: none"> PhD (Hydraulic Engineering) M.Eng (Hydraulic) B.Eng (Hydraulic) 	Subject Consultant	<ul style="list-style-type: none"> Coastal Zone Process and Hydroinformatics 	SS0371	6 th Aug 2017	<ul style="list-style-type: none"> Effluent Dispersion Modelling
11	Elisa Chong Li San	<ul style="list-style-type: none"> B. Sc (Hons) (Industrial Chemistry) M. Sc (Urban Water Engineering and Management) 	EIA Consultant	<ul style="list-style-type: none"> Water Quality Air Quality & Odour Wastewater Scheduled Waste Management 	C0893	31 st Mar 2019	<ul style="list-style-type: none"> Wastewater

Table 1.4 List of EIA Study Team Members (Assistant Consultants)

No.	Name	Qualification	Registration with DOE			Proposed Study Area	Supervised By
			Category	Area / Field	ID No.		
1	Tengku Nuradibah Tengku Khalid	B. Sc (Geology)	Asst. Consultant	<ul style="list-style-type: none"> Geology & Soil Geophysical General Environmental Management 	AC 1151	<ul style="list-style-type: none"> Geology & Soil General Environmental Management 	Dr Mohd Zaki Mohd Said
2	Amir Irfan Sufi Bin Shuib	B. Sc. (Environmental Science)	Asst. Consultant	<ul style="list-style-type: none"> Air Quality and Odour Noise and Vibration General Environmental Management 	AC1153	<ul style="list-style-type: none"> Air Quality 	Lim Sze Fook Tan Poh Aun
4	Nurfathanah Binti Norhayalim	Bachelor of Engineering (Hons.) in Chemical Engineering	Asst. Consultant	<ul style="list-style-type: none"> Quantitative Risk Assessment 	AC 1200	<ul style="list-style-type: none"> Quantitative Risk Assessment 	Adnan Yusop Ali
5	Nursyuhada Binti Mustafa Kamal	Bachelor of Engineering (Hons.) in Chemical Engineering	Asst. Consultant	<ul style="list-style-type: none"> Quantitative Risk Assessment 	AC 1136	<ul style="list-style-type: none"> Quantitative Risk Assessment 	Adnan Yusop Ali
6	Shahrulnazrin Bin Samsudin	BSc (Hons) Ecology	Asst. Consultant	<ul style="list-style-type: none"> Water Quality 	AC1003	<ul style="list-style-type: none"> Effluent Dispersion Modelling Air Quality 	Dr. Juan Carlos Savioli Tan Poh Aun

	ADDITIONAL INFORMATION TO THE DEIA REFINERY AND PETROCHEMICAL INTEGRATED DEVELOPMENT (RAPID) PROJECT, PENGERANG JOHOR, 2012 TO INCLUDE EURO 5 MOGAS AND OLEFIN TANK UNITS	
	CHAPTER 1 INTRODUCTION	

No.	Name	Qualification	Registration with DOE			Proposed Study Area	Supervised By
			Category	Area / Field	ID No.		
7	Siti Norfaezah Binti Azlan	Bachelor Of Medical Science Technology In Environmental Healthcare (Hons.)	Asst. Consultant	<ul style="list-style-type: none"> Health Impact Assessment Air/Noise Quality 	AC 5054	<ul style="list-style-type: none"> Health Impact Assessment Air Quality and Odour 	Prof. Dr Jamal Hisham Hashim Lim Sze Fook
8	Lily Nur Hidayah Binti Abdul Razak	BSc. (Hons) Environmental Technology.	Asst. Consultant	<ul style="list-style-type: none"> Water Quality Air/Noise Quality Solid Waste Management 	AC5041	<ul style="list-style-type: none"> Noise Dissipation Modelling Solid Waste Management 	Dr. Salman Leong Azemi Abu Bakar

	ADDITIONAL INFORMATION TO THE DEIA REFINERY AND PETROCHEMICAL INTEGRATED DEVELOPMENT (RAPID) PROJECT, PENGERANG JOHOR, 2012 TO INCLUDE EURO 5 MOGAS AND OLEFIN TANK UNITS	
	PROJECT DESCRIPTION	

2 PROJECT DESCRIPTION

2.1 PROJECT LOCATION

RAPID is located on 6,424 acres of land in West Pengerang, District of Kota Tinggi, south-east of Johor. RAPID is bounded by the Strait of Singapore and Road J52 to the south (connecting Sg Rengit to Tg Pengelih), Road 92 to the east (from Sg Rengit to Kota Tinggi) and Sebana Cove Resort to the north. The overall RAPID Project boundary remains the same as in the previously approved RAPID DEIA, 2012, however some of the facilities within the Complex has been relocated or modified based on the current market trends and demands.

RAPID Project boundary and the Refinery Cracker Complex boundary is as presented in **Figure 2.3**.

Table 2.1: RAPID Complex Site Boundary

Component					
RAPID			Refinery Cracker Complex		
Point	Easting (E)	Northing (N)	Point	Easting (E)	Northing (N)
A	61985.781	-73342.360	R1	66417.436	-73441.885
B	69119.249	-72359.694	R2	67838.258	-73349.464
C	61932.098	-75495.462	R3	68738.433	-75939.186
D	69175.709	-76153.254	R4	66669.791	-76313.417

Source: PETRONAS, 2016

2.2 CHANGES TO THE OVERALL RAPID COMPLEX

The changes to the overall RAPID Complex from that in RAPID DEIA 2012 is summarised in **Table 2-2** and shown in **Figure 2-2**.



	ADDITIONAL INFORMATION TO THE DEIA REFINERY AND PETROCHEMICAL INTEGRATED DEVELOPMENT (RAPID) PROJECT, PENERANG JOHOR, 2012 TO INCLUDE EURO 5 MOGAS AND OLEFIN TANK UNITS	
	PROJECT DESCRIPTION	

Table 2.2: Brief on the Changes in RAPID Complex

No	Details as per original Plot Plan	Status on Overall the Plot Plan Layout	Remarks
1.	Flare System	Maintained	The Flare Area has been segregated into Refinery Flare System, Steam Cracker Complex (SCC) and PETCHEM Flare System
2.	Pengerang Cogeneration Plant (PCP)	Relocated	<p>Previously, PCP was located on the southern boundary of RAPID, South of the Petrochemical Storage (refer to Figure 2-1).</p> <p>PCP has been shifted to the west of the Admin Building Near the North-eastern boundary of the RAPID Project Site (refer to Figure 2-2).</p>
3.	Refinery and Refinery Storage	Maintained except for the following: a) Sulphur Recovery Unit (SRU) b) Refinery Storage (renamed to Refinery Tank Farm)	<p>Refinery Process Area consists of the following units (refer to Figure 2-2):</p> <ul style="list-style-type: none"> • Amine Regeneration Unit (ARU); • Sour Water Stripping (SWS); • LPG Treating Unit (LTU); • Residue Fluidized Catalytic Cracking (RFCC); • Atmospheric Residue Desulphurisation Unit (ARDS); • Hydrogen Collection and Distribution (HCDU); • Crude Distillation Unit (CDU); • Continuous Catalytic Reformer (CCR); • Naphtha Hydrotreating (NHT); • Cracked Naphtha Hydrotreating (CNHT); • Kerosene Hydrotreating (KHT); • Diesel Hydrotreating (DHT); • Hydrogen Production Unit (HPU); • Refinery Pressure Swing Adsorption (RPSA); and • Saturated Gas Plant (SGP). <p>The location of all the above-mentioned components of the Refinery are maintained the same as discussed in the RAPID DEIA, 2012 except for the Sulphur Recovery Unit (SRU) unit and Refinery Tank Farm as discussed below:</p> <ul style="list-style-type: none"> • Sulphur Recovery Unit (SRU) <ul style="list-style-type: none"> a) Liquid Sulphur Storage Unit (LSSU) and Sulphur Solidification Unit (SSU), previously located at the Southern boundary of RAPID Project Site, has been shifted to the original Refinery area within the SRU block. b) The solid Sulphur conveyor from the SRU unit to the Sulphur stockpile area has been removed. The solid materials will be transported via trucks using the RAPID internal road. The only Sulphur conveyor maintained is from the Solid Product Warehouse and Sulphur stockpile area to jetty for product loading into vessel. c) The solid Sulphur is to be stored at the solid Sulphur stockpile area located at the south close to the Solid Product Jetty. • Additional of 3 process units for the EURO 5 MOGAS production within the Refinery Cracker Complex as indicated in Figure 2.3. • Refinery Tank Farm <p>Refinery Tank Farm area has been expanded to include the Olefin Tankages and EURO 5 MOGAS tanks as indicated in Figure 2.3. The new olefin storage tankages located in the current refinery tank farms consists of:</p> <ol style="list-style-type: none"> 1. Four mounded bullets for Butadiene Storage 2. One Ethylene Tank 3. Four spheres for Propylene Storage <p>Additional 3 process units and the Refinery Tank Farm will be covered in this EIA study</p>



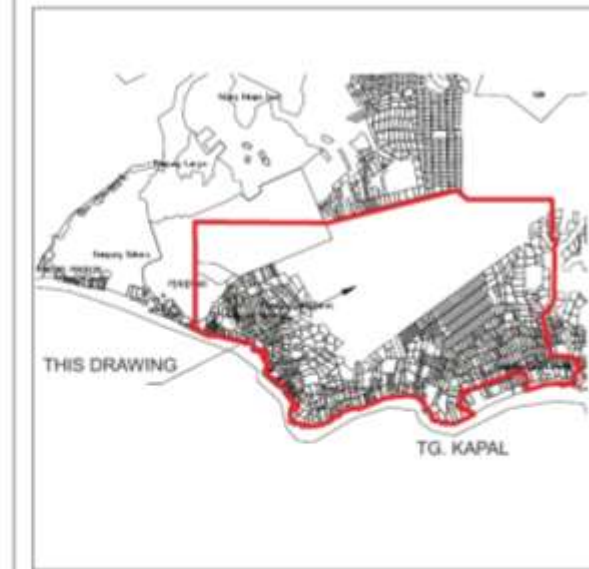
PROJECT DESCRIPTION

No	Details as per original Plot Plan	Status on Overall the Plot Plan Layout	Remarks
4.	Utilities	<p>Changes Include:</p> <ul style="list-style-type: none"> a) Addition of utility areas b) Relocation of the Air Separation Unit (ASU) c) Resource and Recovery Facility (RRF) removal d) Centralised Effluent Treatment Plant (ETP) Outfall location e) Stormwater Drainage, Pond and Outfall location 	<ul style="list-style-type: none"> • In the original design, there were two (2) utility area namely, (refer to Figure 2-1): <ul style="list-style-type: none"> a) Utility Area 1 between the Refinery and Admin Building consisting of Raw Water Treatment Facility and Water Distribution Area. b) Utility Area 2 on the west of the Refinery Storage consisting of Wastewater Treatment Plant and Resource and Recovery Facility (RRF). • There are now three (3) Utility Areas in the revised Plot Plan as presented below (refer to Figure 2-2): <ul style="list-style-type: none"> • Utility Area 1, located to the west of the Refinery area, consisting the following: <ul style="list-style-type: none"> a) Secondary Waste Temporary Storage (for Utility Services) b) Power Generation Unit c) Steam Generation and Associated Facilities d) Air Supply System e) Fuel Gas Supply System f) Cooling Water System (except for Petrochemical Plants where it is to be located within the Petrochemical Complex) g) Caustic System h) Utility Centre Interconnecting • Utility Area 2, located south of the Technical Building Complex and PCP, consisting of: <ul style="list-style-type: none"> a) Raw Water Treatment Plant b) Water Supply System including the Water Distribution network • Utility Area 3, located near the Southern boundary of the RAPID Petrochemical Complex, consisting of: <ul style="list-style-type: none"> a) Effluent Treatment Unit b) Demineralized Water System c) Fire Water System d) Storm Water Pond and Drainage Network • The capacity of the above equipment within the Utility Areas are maintained as detailed out in previously approved RAPID DEIA except for slight modification to the following equipment: <ul style="list-style-type: none"> a) Demineralized Water Treatment <p>Previously, the Unit was located west of the Refinery Complex south of the Flare Area (refer to Figure 2-1). Currently, the unit has been integrated and part of the Water Treatment Generation and Distribution System east of the Refinery Complex south of the PCP Plant. (refer to Figure 2-2)</p> b) Relocation of the Air Separation Unit as shown in Figure 2-2; c) Waste Management Centre (RRF) removed. d) Centralised Effluent Treatment Plant (ETP) Outfall location <p>The ETP Outfall design has been shifted from its original location as shown in Figure 2-1 and to include a 1.5 km inland pipeline and 1.5km offshore pipeline as in Figure 2-2.</p> e) Stormwater Drainage, Pond and Outfall location <p>Three (3) storm water ponds will be provided during operation instead of one (1) pond as in the previous DEIA;</p>
5.	Non-Process Building	Maintained	<p>The Non-Process Building Area is divided into:</p> <ul style="list-style-type: none"> a) Common Administration Building to house all RAPID Complex plant operational administration offices b) Technical building such as warehouse, maintenance workshop and centralised main laboratory;



PETRONAS

PROJECT DESCRIPTION



Key Plan

Legend

-  RAPID Development Site
-  Ornamental trees

Figure 2-1: Overall Plot Plan Layout as in the RAPID DEIA, 2012

Source: DEIA RAPID, 2012



PROJECT DESCRIPTION

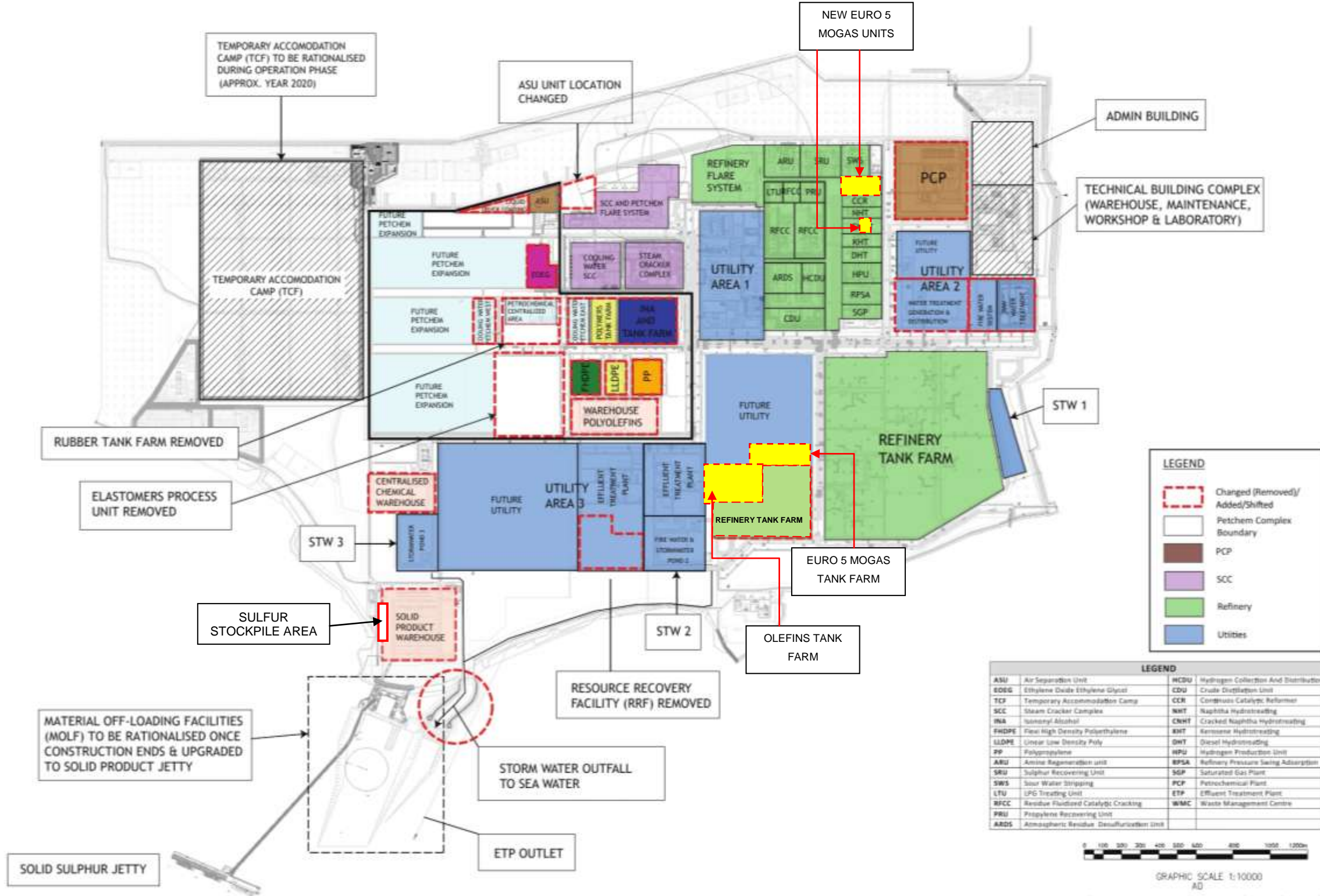




Figure 2-2: Changes to the RAPID Overall Plot Plan

	ADDITIONAL INFORMATION TO THE DEIA REFINERY AND PETROCHEMICAL INTEGRATED DEVELOPMENT (RAPID) PROJECT, PENERANG JOHOR, 2012 TO INCLUDE EURO 5 MOGAS AND OLEFIN TANK UNITS	
	PROJECT DESCRIPTION	

2.3 PROGRESS OF RAPID PROJECT

2.3.1 Current Status of the Overall Project

The RAPID site clearing and preparation works were divided into two (2) phases i.e. Phase 1 and Phase 2 to match the affected population relocation plan and schedule. Phase 1 and Phase 2 Site Clearing and Preparation Works commenced in October 2012 and July 2014, respectively.

Phase 1 Site Preparation works has been completed and current on-going activities taking place are the preliminary Construction Works such as piling, construction of temporary common facilities and worker's accommodation. As of September 2016, the Site Preparation works for Phase 2 was completed.



The overall progress of the construction works at site as of September 2016, is at 44.6% as presented in **Table 2-3**.

Table 2.3: Status of RAPID Construction Progress (as of September, 2016)

No.	Construction Progress Summary	Current Construction Progress
1.	Refinery & Cracker	53%
2.	Petrochemical Complex	9.4%
3.	Utilities and Interconnecting	32.7%
4.	Infra and Offsite Facilities	61%
5.	Power and Gas	63%
6	Associated Facilities	55.9%
Overall RAPID Construction Progress as of September, 2016		44.6%

Source: PETRONAS, 2016

The proposed changes will not pose any additional environmental impact during the construction phase of the project.

	ADDITIONAL INFORMATION TO THE DEIA REFINERY AND PETROCHEMICAL INTEGRATED DEVELOPMENT (RAPID) PROJECT, PENERANG JOHOR, 2012 TO INCLUDE EURO 5 MOGAS AND OLEFIN TANK UNITS	
	PROJECT DESCRIPTION	

2.4 UPDATE ON THE LATEST DEVELOPMENT IN THE RAPID REFINERY CRACKER COMPLEX

This section discusses the specific changes that are covered by this EIA Study.

2.4.1 Changes from Previous Approved RAPID DEIA 2012

The RAPID Refinery Cracker Complex have undergone changes since the RAPID DEIA was approved in 2012. The design of the RAPID Refinery Complex has recently been upgraded by incorporating the production of Motor Gasoline or MOGAS (Euro 5 specifications). Erstwhile design of the RAPID Refinery Complex, had the capability to produce MOGAS (Euro 4 specifications) and Diesel (Euro 5 specifications).

A typical MOGAS consists of hydrocarbons with between 4 and 12 carbon atoms per molecule (commonly referred to as C₄-C₁₂). It is a mixture of paraffin, naphthene and olefin. Various refinery streams are blended to make gasoline. Typically, to convert the process to produce MOGAS that meets Euro 5 specification from Euro 4 specification, the sulphur content must be brought down and the addition of an Oxygenate. Oxygenate blending adds oxygen-bearing compounds which reduces the amount of carbon monoxide and unburned fuel in the exhaust gas.

This change from Euro 4 to Euro 5 specifications for the MOGAS will reduce the generation of acid gases and carbon monoxide, meeting Malaysia's commitment under the Kyoto Protocol in reducing harmful greenhouse gases.

Three new Process units and additional storage tanks for MOGAS 5 and Olefin Storage have been added and are as listed in **Table 2.4** below:





	ADDITIONAL INFORMATION TO THE DEIA REFINERY AND PETROCHEMICAL INTEGRATED DEVELOPMENT (RAPID) PROJECT, PENGERANG JOHOR, 2012 TO INCLUDE EURO 5 MOGAS AND OLEFIN TANK UNITS	
	PROJECT DESCRIPTION	

Table 2.4: RAPID Refinery Latest Development

No.	Process Units/Tankages	Refinery based on 2012 design	Current Refinery 2016	Abbreviation
1.	Crude Distillation Unit	Included	Maintained	CDU
2.	Atmospheric Residue Desulphurisation Unit	Included	Maintained	ARDU
3.	Kerosene Hydrotreating Unit	Included	Maintained	KHT
4.	Diesel Hydrotreating Unit	Included	Maintained	DHT
5.	Residue Fluidised Cracker Unit	Included	Maintained	RFCC
6.	LPG Treating Unit	Included	Maintained	LTU
7.	Cracked Naphta Hydrotreating Unit	Included	Maintained	CNHT
8.	Naphta Hydrotreating Unit	Included	Maintained	NHT
9.	Continuous Catalytic Reformer Unit	Included	Maintained	CCR
10.	Saturated Gas Plant	Included	Maintained	SGP
11.	Hydrogen Production Unit	Included	Maintained	HPU
12.	Amine Regeneration Unit	Included	Maintained	ARU
13.	Sour Water Stripping Unit	Included	Maintained	SWS
14.	Sulphur Recovery Unit & Tail Gas Treating Unit	Included	Maintained	SRU
15.	Hydrogen Collection and Distribution	Included	Maintained	HCDU
16.	Refinery Pressure Swing Adsorption	Included	Maintained	RPSA
17.	2 nd Stage Cracked Naphta Hydrotreating (CNHT 2) Unit	Not Included	New	CNHT 2
18.	C ₅ /C ₆ Isomerisation Unit	Not Included	New	ISOM
19.	Etherification Unit Tertiary-Armyl-Methyl-Ether (TAME)	Not Included	New	TAME
20.	Tankages for EURO 5 MOGAS Units	Not Included	New	N/A
21.	Additional Olefins Storage	Not Included	New	N/A

Source: PETRONAS, 2016

 PETRONAS	ADDITIONAL INFORMATION TO THE DEIA REFINERY AND PETROCHEMICAL INTEGRATED DEVELOPMENT (RAPID) PROJECT, PENERANG JOHOR, 2012 TO INCLUDE EURO 5 MOGAS AND OLEFIN TANK UNITS	 INTEGRATED ENVIROTECH
PROJECT DESCRIPTION		

The above highlighted five Units will be added to the overall system to achieve the required changes to meet the specifications and provide additional storage. The CHNT2 Unit and Isomerisation Unit extract the sulphur in their respective feedstock before blending into the gasoline. While the TAME unit breaks down the incoming feedstock in the presence of Methanol enabling the reduction in the generation of carbon monoxide during its use. After the TAME unit the product is channelled for Gasoline blending.

Figure 2-5 presents the previous overall block flow diagram of the RAPID Refinery Complex as in RAPID DEIA 2012 whilst **Figure 2-6** shows the latest Refinery Cracker complex overall block flow diagram.

The MOGAS 5 units and Tankages for the MOGAS units are discussed in **Section 2.4.2** while the Additional Olefin Storage are discussed in **Section 2.4.3**. As these two systems are discrete, the process, the emissions generated and implementation are discussed separately.

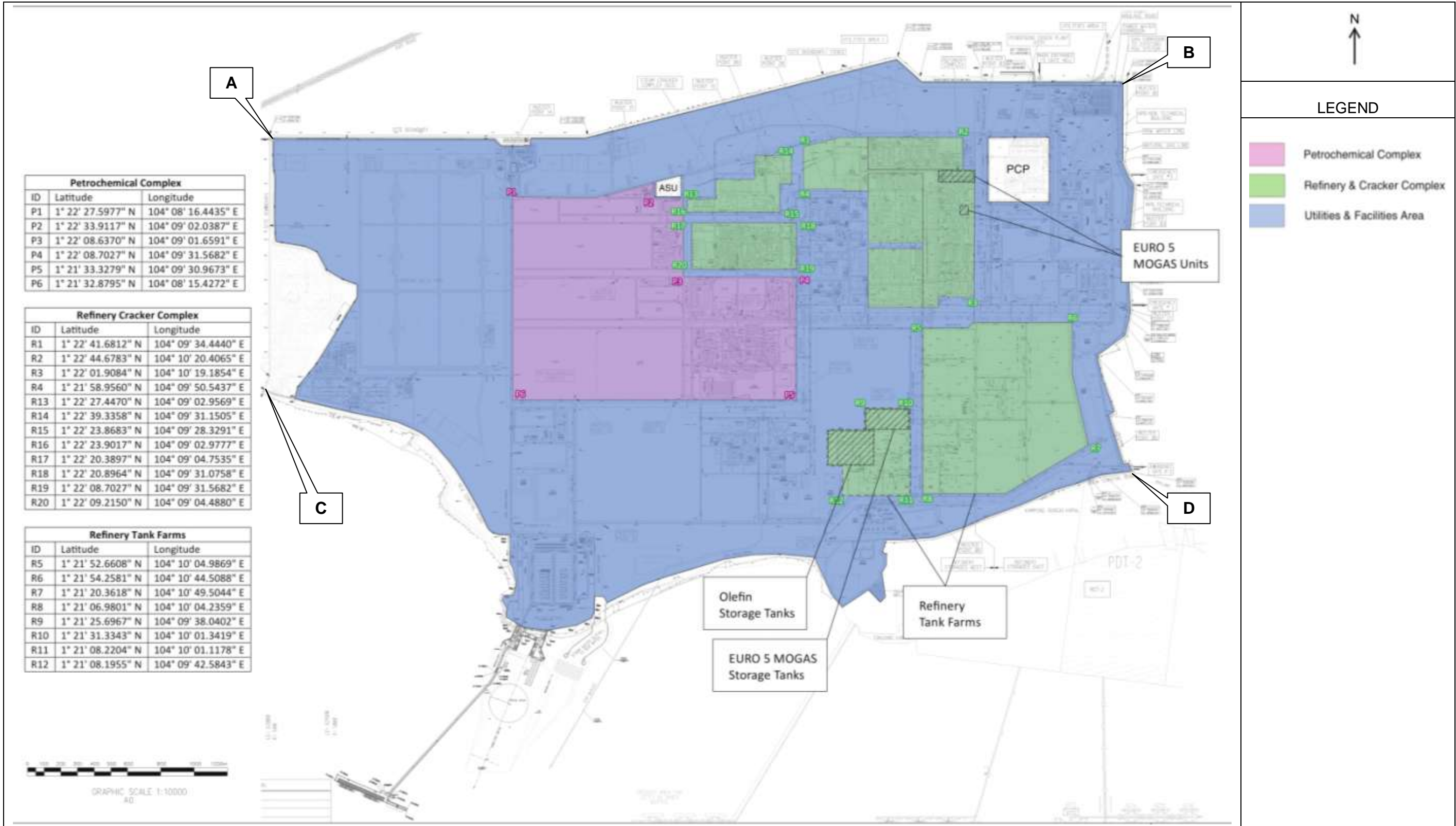
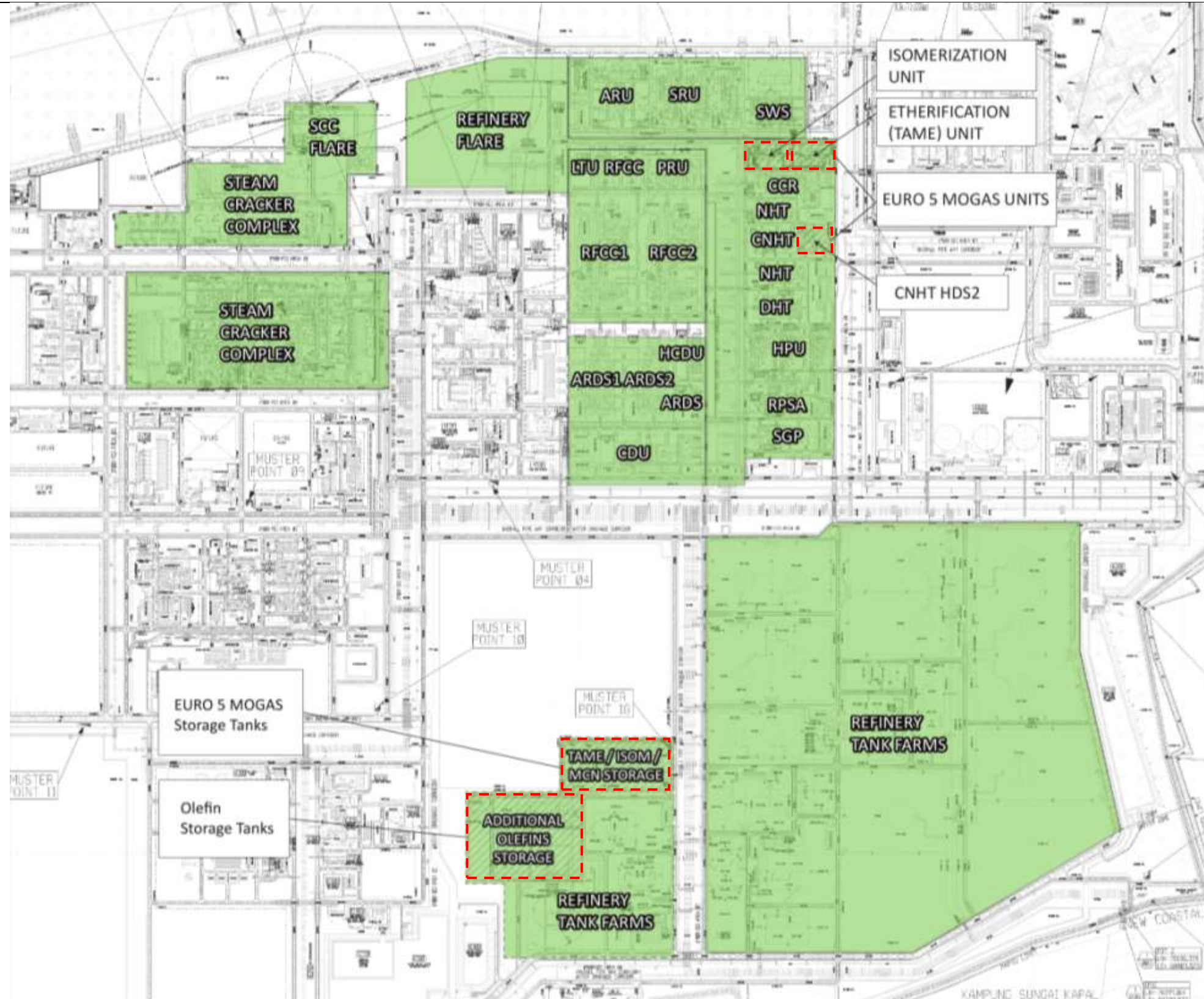


Figure 2-3: Plot Plan Layout of the Refinery and Cracker Complex 2016



PROJECT DESCRIPTION



LEGEND

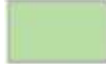
 Refinery & Cracker Complex

Figure 2-4: Plot Plan of Refinery and Cracker Complex 2016



PROJECT DESCRIPTION

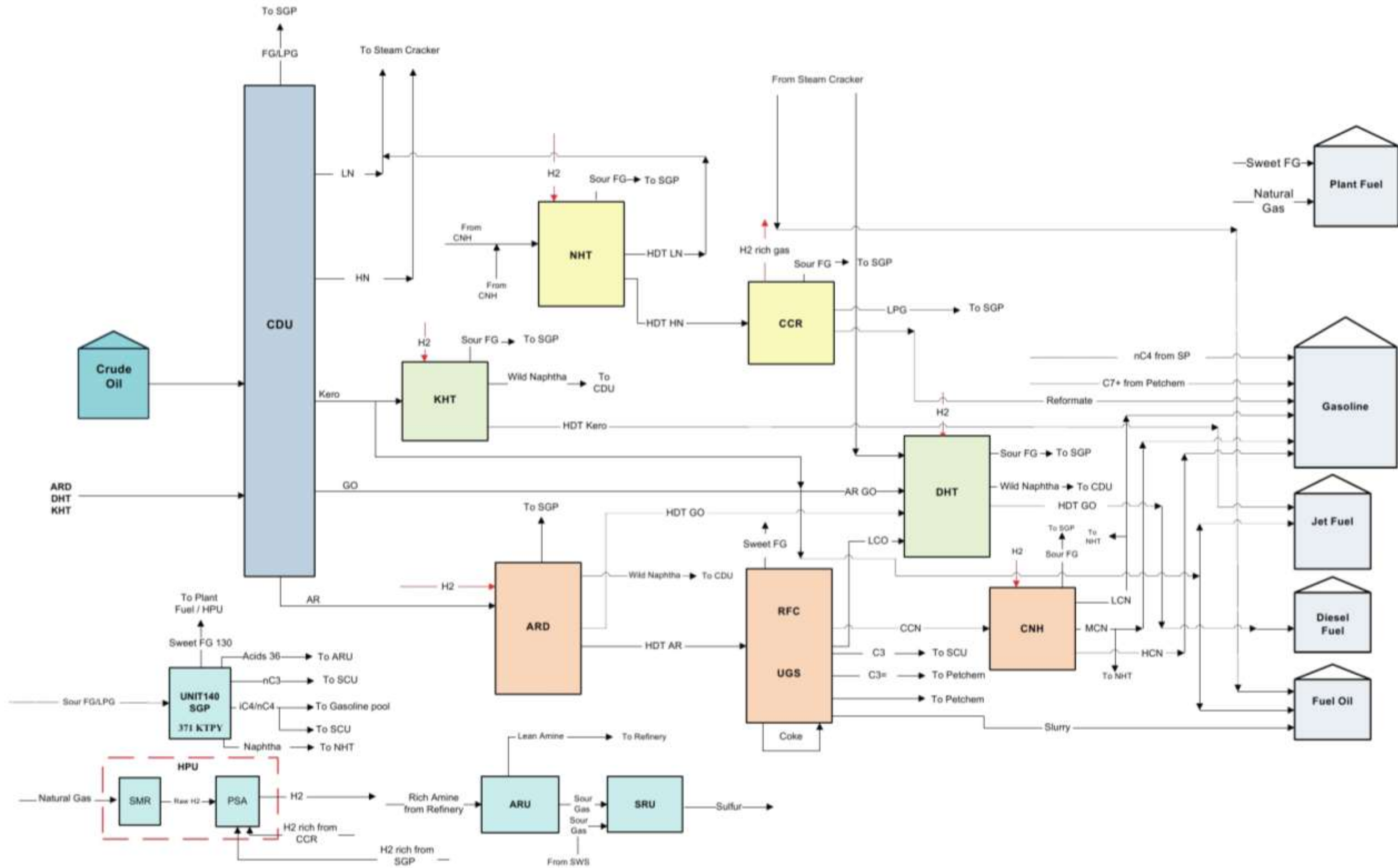


Figure 2-5: Overall Block Flow Diagram for RAPID Refinery Complex as in RAPID DEIA, 2012



PROJECT DESCRIPTION

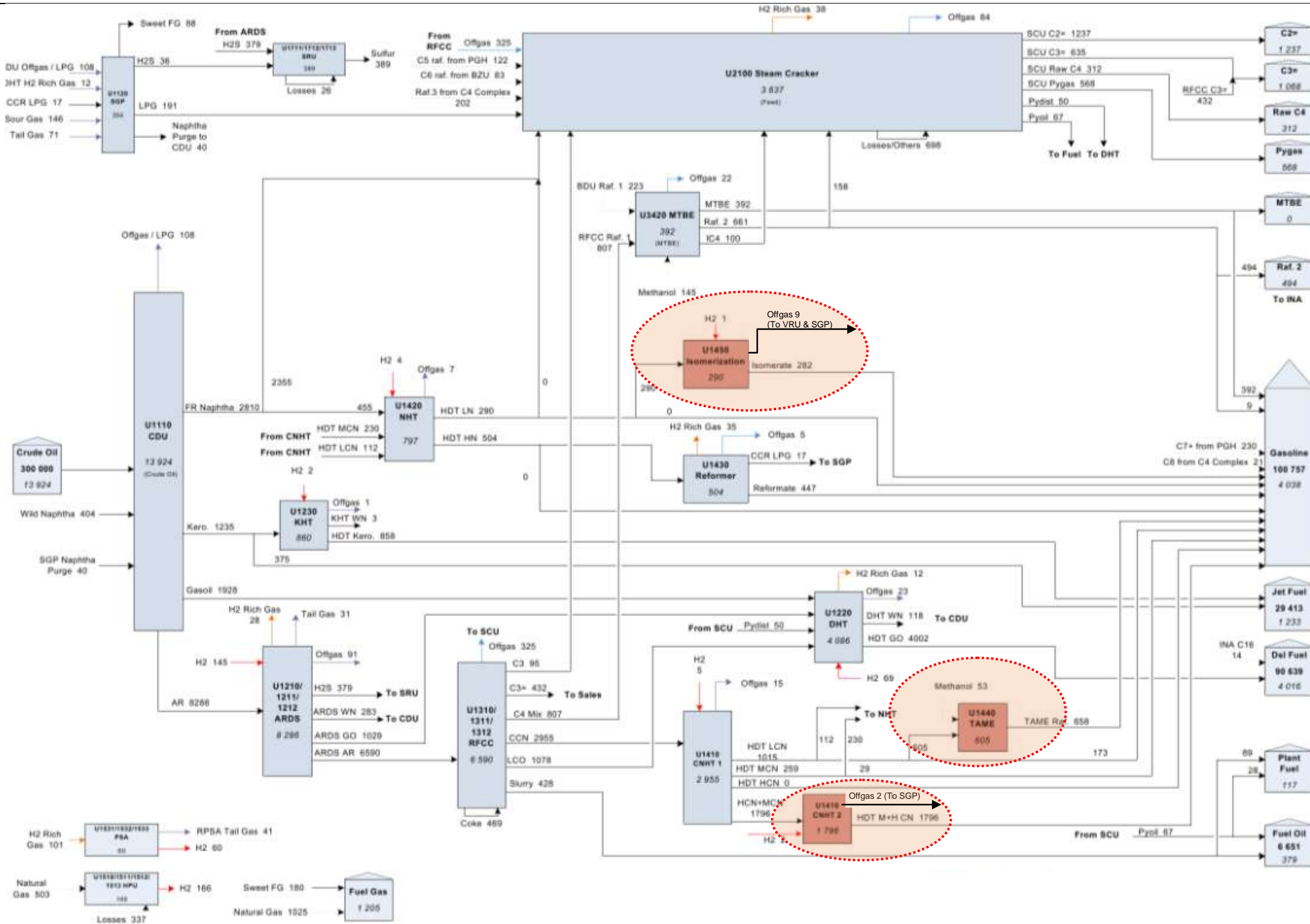




Figure 2-6: Current Overall Block Flow Diagram for RAPID Refinery & Cracker Complex With EURO 5 MOGAS Units

	ADDITIONAL INFORMATION TO THE DEIA REFINERY AND PETROCHEMICAL INTEGRATED DEVELOPMENT (RAPID) PROJECT, PENERANG JOHOR, 2012 TO INCLUDE EURO 5 MOGAS AND OLEFIN TANK UNITS	
	PROJECT DESCRIPTION	

2.4.2 EURO 5 MOGAS

The RAPID Refinery Cracker Complex was designed to produce diesel that meet the EURO 5 specifications and MOGAS (motor gasoline) that meet EURO 4 specifications. In response to the gazetted EURO 5 Standards for diesel and petrol (motor gasoline) by the Malaysian Government in 2015, RAPID will incorporate design changes to meet the EURO 5 MOGAS specification. Additional units required to meet the EURO 5 MOGAS specification are shown in **Table 2.5**.

Table 2.5: New Units Required for EURO 5 MOGAS Production

No	Unit	Function
1	2 nd Stage Cracked Naphta Hydrotreating (CNHT) Unit (CNHT 2)	<ul style="list-style-type: none"> • Sulphur Reduction • Octane Retention
2	Etherification Unit Tertiary-Amyl-Methyl-Ether (TAME)	<ul style="list-style-type: none"> • Olefins saturation • Octane gain
3	Isomerisation Unit	<ul style="list-style-type: none"> • Octane improvement • Aromatic/olefins/Sulphur free
4	Additional Storage Tanks <ul style="list-style-type: none"> i. Two (2) Tertiary-Amyl-Methyl-Ether (TAME) storage tanks ii. Two (2) Isomerase storage tanks iii. One (1) Medium Cracked Naphtha (MCN) storage tank 	<ul style="list-style-type: none"> • Product storage

The table, **Table 2.6** below presents the specification requirements for Euro 4M and Euro 5.



	ADDITIONAL INFORMATION TO THE DEIA REFINERY AND PETROCHEMICAL INTEGRATED DEVELOPMENT (RAPID) PROJECT, PENERANG JOHOR, 2012 TO INCLUDE EURO 5 MOGAS AND OLEFIN TANK UNITS	
	PROJECT DESCRIPTION	

Table 2.6: Motor Gasoline (MOGAS) Specification

Gasoline (MOGAS) Specifications	Euro 4	Euro 5
Specific Gravity (SGP) min-max	0.720-0.780	0.720-0.775
Benzene (% vol.) max	3.5	1.0
Olefin (% vol.) max		18.0
Aromatics (% vol.) max		35.0
Reid Vapour Pressure (kPa) maph	65.0	60.0
Sulphur (ppm wt.) max	50.0	10.0
Oxygen (% wt.) max		2.7
Research octane Number /Motor Octane Number	95	95/85
Evap 70°C (vol.%) min-max		20.0-48.0 (class A)
Evap 100°C (vol.%) min-max		46.0-71.0
Evap 150°C (vol.%) min		75.0
Final Boiling Point (°C) max	215	210

2.4.2.1 Feedstock and Product

Summary of the feedstock and products from the EURO 5 MOGAS process units is listed in **Table 2.7**.



	ADDITIONAL INFORMATION TO THE DEIA REFINERY AND PETROCHEMICAL INTEGRATED DEVELOPMENT (RAPID) PROJECT, PENERANG JOHOR, 2012 TO INCLUDE EURO 5 MOGAS AND OLEFIN TANK UNITS	
	PROJECT DESCRIPTION	

Table 2.7: Summary of Raw Material and Products of the EURO 5 MOGAS Production

No	Process Units	Raw Material			Output	
		Name	Quantity (kt/y)	Source	Name	Quantity (kt/y)
1	Cracked Naphta Hydrotreatment Unit 2 (CNHT 2)	Heavy Cracked Naphta (HCN) + Medium Cracked Naphta (MCN)	1796	Cracked Naphta Hydrotreatment Unit 1 (CNHT 1)	Hydrotreated Medium + Heavy Cracked Naphta (HDT M + H CN) (Desulphurised Product)	1796
		Hydrogen (H ₂)	2	Hydrogen Collection & Distribution Unit (HCDU)	Off gases to Saturated Gas Plant (SGP)	2
2	Isomerisation Unit	Hydrotreated Light Naphta (HDT LN)	290	Naphta Hydrotreatment Unit (NHT)	Isomerate	282
		Hydrogen (H ₂)	1	Hydrogen Collection & Distribution Unit (HCDU)	Off gases to Saturated Gas Plant (SGP)	9
3	TAME	Light Cracked Naphta (LCN)	605	Cracked Naphta Hydrotreatment Unit 1	TAME Raffinate	658
		Methanol	53	Methanol Make-Up Storage		



(Source: Overall Block Flow Diagram for Refinery Cracker Complex, 2016)

2.4.2.2 Process Description of Additional Units for EURO 5 MOGAS Production

The RAPID Refinery Cracker Complex was originally designed to produce diesel that meet the EURO 5 specifications and MOGAS (motor gasoline) that meet EURO 4 specifications. However, with new directives, RAPID will now produce MOGAS to meet the EURO 5 specification. Additional units required to meet the EURO 5 MOGAS specification include:

i. Cracked Naphta Hydrotreatment Unit 2 (CNHT 2)

The Heavy Cracked Naphta (HCN) + Medium Cracked Naphta (MCN) which was previously direct fed into the Gasoline Blending, is now processed in the second Cracked Naphta Hydrotreatment Unit to remove the sulphur. This achieved by treating the HCN and MCN with

	<p style="text-align: center;">ADDITIONAL INFORMATION TO THE DEIA REFINERY AND PETROCHEMICAL INTEGRATED DEVELOPMENT (RAPID) PROJECT, PENGERANG JOHOR, 2012 TO INCLUDE EURO 5 MOGAS AND OLEFIN TANK UNITS</p>	
	<p style="text-align: center;">PROJECT DESCRIPTION</p>	

Hydrogen gas. The off gases generated will be sent to the Saturated Gas Plant to remove the H₂S gas.

ii. Isomerisation Unit

The Hydrotreated Light Naphta (HDT LN) from the Naphta Hydrotreatment Unit (NHT) was previous sent directly for Gasoline Blending. With the introduction of the Isomerisation Unit, the HDT LN is treated with hydrogen to further reduce the sulphur content. This achieved by treating the HCN and MCN with Hydrogen gas. The off gases generated will be sent to the Saturated Gas Plant to remove the H₂S gas.

iii. Tertiary-Amyl-Methyl-Ether (TAME) Unit

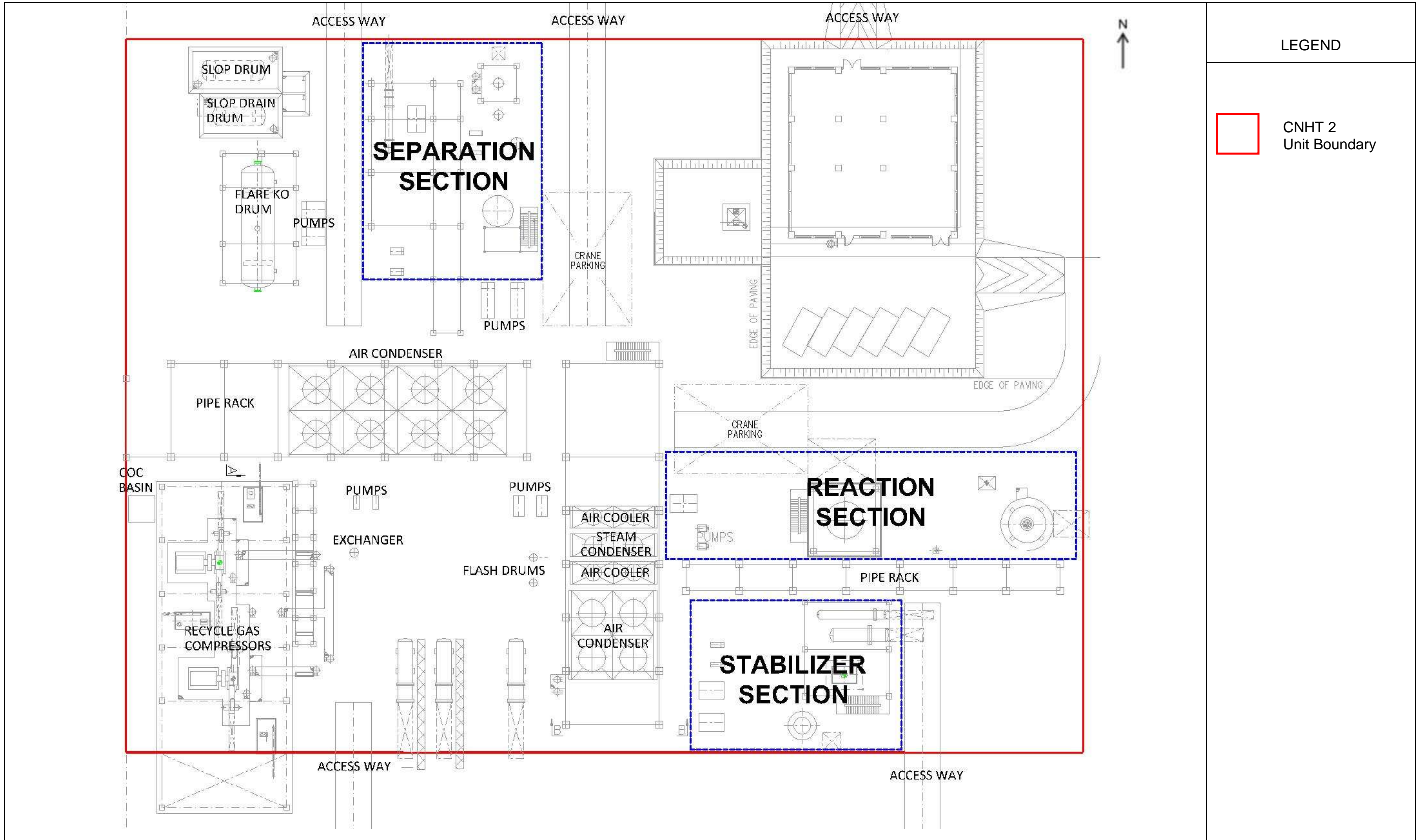
The Hydrotreated Light Cracked Naphta (HDT LCN) from the Cracked Naphta Hydrotreatment Unit 1 was previously sent directly Gasoline Blending, is now processed in the TAME Unit. The HDT LCN with methanol undergoes an etherification process to form TAME raffinate.

The detailed process description for each process are elaborated in the following sections.

The layout plan for the new EURO 5 MOGAS units are shown in Figures, **Figure 2-7** to **Figure 2-9**.The layout plan for the new EURO 5 MOGAS storage tanks are shown in **Figure 2-10**.



PETRONAS



LEGEND


 CNHT 2 Unit Boundary

Figure 2-7: Layout Plan of Unit CNHT 2



PROJECT DESCRIPTION

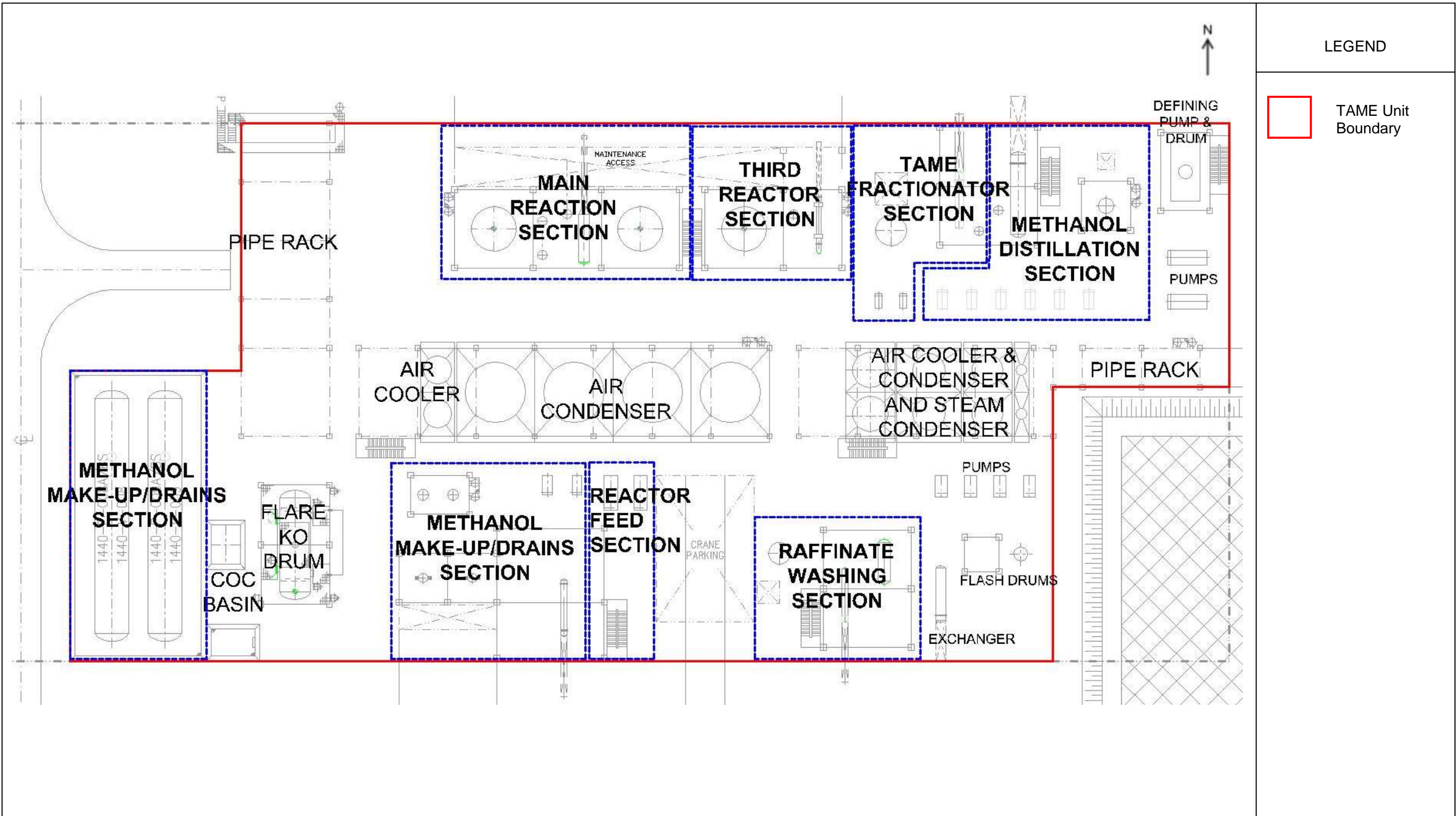


Figure 2-8: Tertiary-Amyl-Methyl-Ether (TAME) Unit Layout Plan



PETRONAS

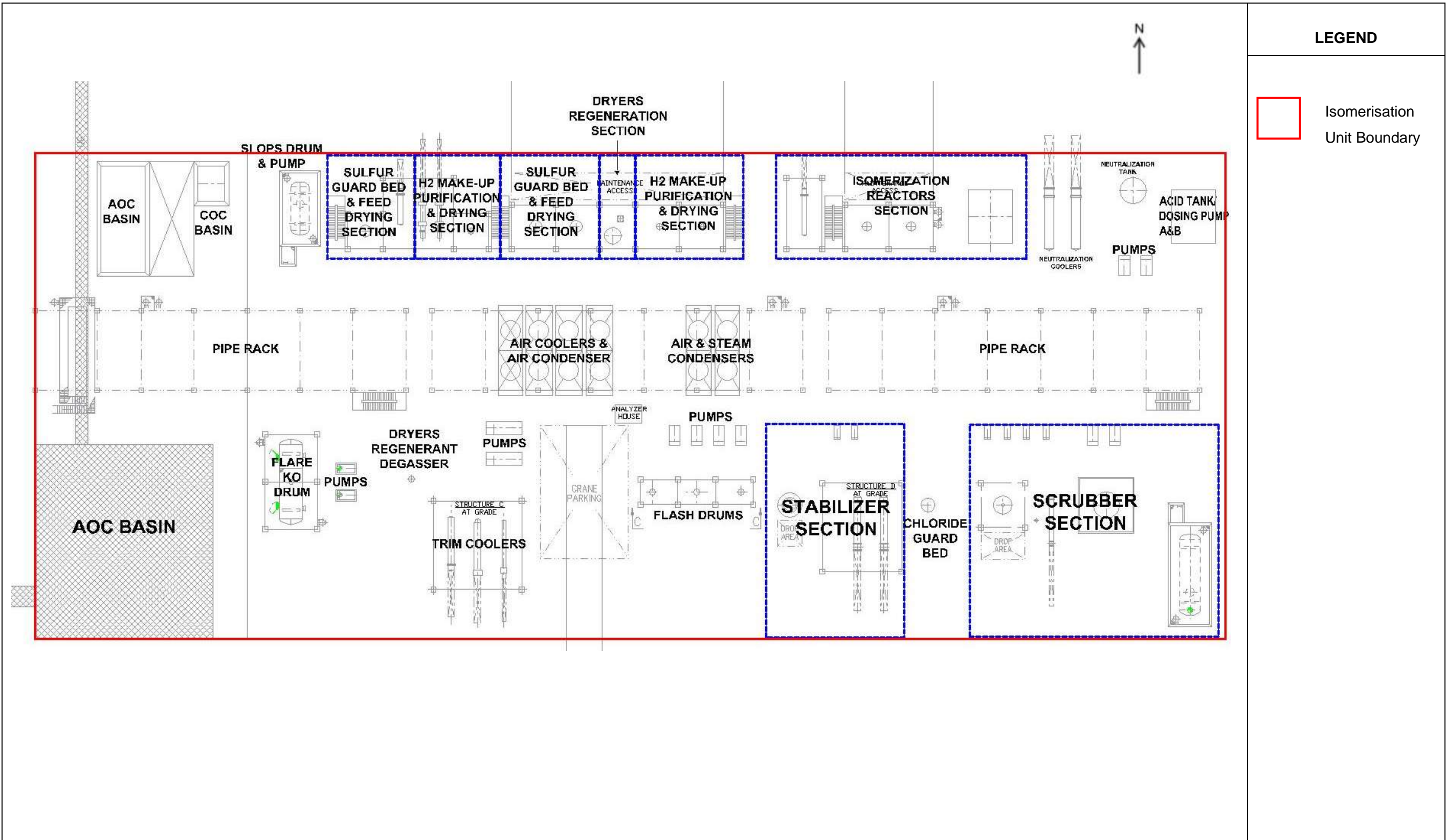


Figure 2-9: Isomerisation Unit Layout Plan



PETRONAS

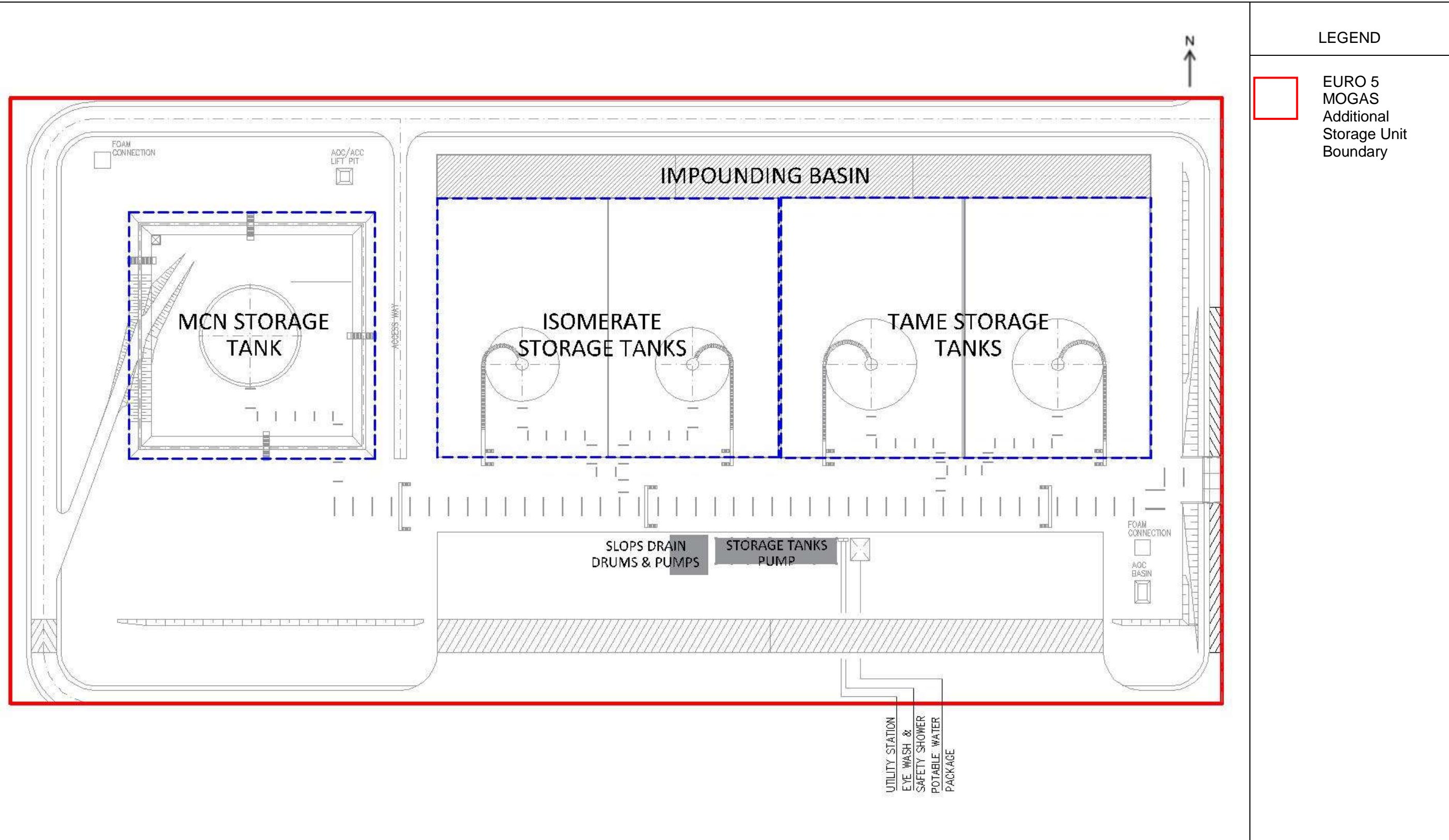




Figure 2-10: Additional Storage Tanks For EURO 5 MOGAS Unit

	ADDITIONAL INFORMATION TO THE DEIA REFINERY AND PETROCHEMICAL INTEGRATED DEVELOPMENT (RAPID) PROJECT, PENERANG JOHOR, 2012 TO INCLUDE EURO 5 MOGAS AND OLEFIN TANK UNITS	
	PROJECT DESCRIPTION	

2.4.2.2.1 Cracked Naphtha Hydrotreating Unit (CNHT): Second Stage Hydrodesulphurisation (HDS) Section (CNHT 2)



The main units under CNHT 2 are:

1. Reaction section
2. Separation section
3. Stabiliser section

2.4.2.2.1.1 Reaction Section

The second stage HDS section in the EURO 5 MOGAS Units feed combines the partially treated Heavy Cracked Naphtha (HCN) product from HCN Stabiliser Feed / Bottoms Exchangers and part of Medium Cracked Naphtha (MCN) product from MCN/HCN. This feed is then routed to the Second Stage HDS where it is mixed with the recycle gas stream from the Second Stage HDS Recycle Gas Compressors and is preheated in the Second Stage HDS Reactor Feed / Effluent Exchangers (shell side) before entering the Second Stage HDS Reactor.

The Second Stage HDS Reactor is a downflow two-bed Reactor. It contains an inter-bed liquid quench zone to control the overall heat generated during the exothermic reaction. A portion of the liquid from the Second Stage HDS Separator Drum is used for quenching the Reactor. This liquid quench is pumped by the Second Stage HDS Quench Pumps under flow control set and controlled by the second catalyst bed inlet temperature. The Second Stage HDS Reactor effluent is further heated in the Second Stage HDS Reactor Heater. Then, it is cooled down in the Second Stage HDS Reactor Feed / Effluent Exchanger tube side, in the Second Stage HDS Reactor Effluent / Feed Stabiliser Exchanger (tube side) and in the Second Stage HDS Reactor Effluent Air Condenser before entering Second Stage HDS Separator Drum.

	ADDITIONAL INFORMATION TO THE DEIA REFINERY AND PETROCHEMICAL INTEGRATED DEVELOPMENT (RAPID) PROJECT, PENERANG JOHOR, 2012 TO INCLUDE EURO 5 MOGAS AND OLEFIN TANK UNITS	
	PROJECT DESCRIPTION	

During Second Stage HDS Reactor effluent condensation, salt (especially ammonium chloride (NH_4Cl) and ammonium hydrosulfide (NH_4HS)) may precipitate depending on the partial pressures of NH_3 , H_2S and HCl in the vapor phase. To prevent permanent depositing of these chemicals, the HDS effluent is intermittently washed with Stripped Water, prior to be cooled down in the Second Stage HDS Reactor Effluent Air Condenser, or in the Second Stage HDS Reactor Effluent / Feed Stabiliser Exchanger (tube side).

The washing water is intermittently injected at Second Stage HDS Reactor Effluent Air Condenser inlet or at Second Stage HDS Reactor Effluent / Feed Stabiliser Exchanger tube side inlet with the Second Stage HDS Washing Water Pumps.



2.4.2.2.1.2 Separation Section

In the Second Stage HDS Separator Drum, the following three phases are separated out:

- The decant water phase.
- The liquid hydrocarbon phase.
- The vapor hydrocarbon (recycle gas) phase.

The water phase containing H_2S is removed under interface level control and sent to Sour Water Stripping unit (SWS).

A part of the liquid hydrocarbon phase is routed to the second stage HDS Stabiliser section. The other part is pumped by Second Stage HDS Quench Pumps and used as liquid quench for the Second Stage HDS Reactor. The vapor hydrocarbon phase flows to the Second Stage HDS Amine Absorber K.O. Drum, which is equipped with a demister mesh to remove any carried-over liquid droplets. Any liquid from this drum is sent under level control to second stage HDS Stabiliser section. Then the vapor phase is routed to the Second Stage HDS Amine Absorber, where H_2S is

	ADDITIONAL INFORMATION TO THE DEIA REFINERY AND PETROCHEMICAL INTEGRATED DEVELOPMENT (RAPID) PROJECT, PENERANG JOHOR, 2012 TO INCLUDE EURO 5 MOGAS AND OLEFIN TANK UNITS	
	PROJECT DESCRIPTION	



substantially removed from the gas with a dilute Methyl diethanolamine (MDEA) solution.

Rich Amine is withdrawn under level control from the bottom of the Second Stage HDS Amine Absorber and sent to the ARU. The recycled gas leaving the Second Stage HDS Amine Absorber is routed to the Second Stage HDS Recycle Gas Compressors K.O Drum. The Second Stage HDS Recycle Gas Compressor K.O. Drum is equipped with a demister mesh to remove from the recycle gas any carried-over liquid droplets. The liquid part is sent to the Rich Amine Battery limit under level control. The recycle gas is compressed in the Second Stage HDS Recycle Gas Compressors and then is mixed with the hydrogen make-up. The mixture is then sent back to the Second Stage HDS reaction section.

2.4.2.2.1.3 Stabiliser Section

The Second Stage HDS Stabiliser feed is preheated in the HDS Reactor Effluent / Stabiliser Feed Exchanger. The Second Stage Stabiliser overhead is partially condensed in the Second Stage HDS Stabiliser Overhead Air Condenser before entering the Second Stage HDS Stabiliser Reflux Drum. In the Second Stage HDS Stabiliser Reflux Drum, the vapor, hydrocarbon liquid and water phases are separated. The liquid hydrocarbon is pumped by the Second Stage HDS Stabiliser Reflux Pumps and sent back to the top of the column as reflux. The sour vapor phase is sent to the SGP. The sour water phase is pumped by Second Stage HDS Sour Water Pumps to the SWS unit.

The Second Stage HDS Stabiliser bottom is reboiled with the Second Stage HDS Stabiliser Reboiler using Medium Pressure steam under flow control. In case of turndown operation, part of the desulphurised product stream from Second Stage HDS product Air Cooler can be recycled to the Feed Filters Package in order to ensure 60% of minimum of HC feed to SHU reactor for hydrodynamic reasons. The Second Stage HDS Stabiliser bottom product is pumped and sequentially cooled down. The flow of desulphurised product is routed to storage under flow control.

	<p style="text-align: center;"> ADDITIONAL INFORMATION TO THE DEIA REFINERY AND PETROCHEMICAL INTEGRATED DEVELOPMENT (RAPID) PROJECT, PENERANG JOHOR, 2012 TO INCLUDE EURO 5 MOGAS AND OLEFIN TANK UNITS </p>	
	<p style="text-align: center;">PROJECT DESCRIPTION</p>	

2.4.2.2.2 Etherification (TAME) Unit

The main sections of TAME unit are:



1. Reactors Feed Section
2. Main Reaction Section
3. TAME Fractionator Section
4. Third Reactor Section
5. Raffinate Washing Section
6. Methanol Distillation Section
7. Methanol Make-Up/Drains Section

2.4.2.2.1 Reactors Feed Section

The Light Cracked Naphta (LCN) feed is fed directly from the Cracked Naphtha Hydrotreating Unit (CNHT) or from storage.

In order to avoid TAME catalyst poisoning with basic impurities or polar compounds (mainly nitriles), the feed is continuously washed with water. Washing water coming from Cold Condensate network is mixed with hydrocarbon feed at a washing ratio of 30% by wt. The mixing is achieved in a mixing valve (PDC valve) and separated in the LCN Feed Surge Drum where the pressure is maintained by split-range control (Nitrogen/Flare). The hydrocarbon feed is then pumped while spent water is purged to Effluent Treatment Plant (ETP) under level control.

The feed is then mixed with methanol coming from the methanol make-up/drains. An additional water line from cold condensate to methanol distillation section will add fresh water to the recycled water loop.

	ADDITIONAL INFORMATION TO THE DEIA REFINERY AND PETROCHEMICAL INTEGRATED DEVELOPMENT (RAPID) PROJECT, PENERANG JOHOR, 2012 TO INCLUDE EURO 5 MOGAS AND OLEFIN TANK UNITS	
	PROJECT DESCRIPTION	

2.4.2.2.2 Main Reaction Section

The combined hydrocarbon and methanol feed is then preheated by Low Pressure Steam in the Feed Preheater and finally sent to the Feed Filters in order to remove particles, before feeding the First Reactor.

Most of the isoamylenes and other reactive iso-olefins (e.g. $iC_4=$, $iC_5=$ and $iC_6=$) conversion occurs in the first reactor. First Reactor Resin Trap stop the escape of the stored resin in case of resins carry over. The purpose of trapping and filtering here is to avoid plugging downstream reactor's feed distributor. The effluent of the first reactor is cooled down under temperature control in the interstage cooling system before feeding the Second Reactor where an important part of the remaining isoamylenes and other reactive iso-olefins are converted.



Second Reactor Resin Trap protect downstream equipment as well as to avoid catalyst fines build-up at TAME Fractionator bottom (which may lead to TAME back-cracking into methanol and isoamylenes). The pressure of the main reaction section is controlled by a pressure valve located at the second reactor effluent. The second reactor effluent is then mixed with TAA (Tertiary Amyl Alcohol) withdrawn from Methanol Column and sent to TAME Fractionator section.

2.4.2.2.3 TAME Fractionator Section

This section is used to reach high conversion. TAME and light hydrocarbon cut are separated in the TAME Fractionator which recovers:

- Light hydrocarbon cut and the excess of methanol as liquid distillate.
- TAME and heavy hydrocarbon cut as bottom product.

After pressure let-down, the second reactor effluent is preheated in the Second Reactor Effluent/Methanol Column Top Exchanger. The reactor effluent is then further heated in TAME Fractionator Feed/Bottom Exchanger, before feeding the TAME Fractionator.

	ADDITIONAL INFORMATION TO THE DEIA REFINERY AND PETROCHEMICAL INTEGRATED DEVELOPMENT (RAPID) PROJECT, PENERANG JOHOR, 2012 TO INCLUDE EURO 5 MOGAS AND OLEFIN TANK UNITS	
	PROJECT DESCRIPTION	

The TAME product is routed to be mixed with raffinate product. Then it is cooled down in the TAME Fractionator Feed/Bottom Exchanger. The composition of this stream is indicated by an online analyser, which monitors mainly the concentration of TAME, methanol, reactive iso-olefins (iC₅= and iC₆=) and TAA. Finally, the TAME product is mixed with Raffinate product from Raffinate Coalescer and then sent to TAME+Raffinate Product Storage.



The overhead product of the TAME Fractionator is fully condensed and then goes to the TAME Fractionator Reflux Drum. In case of presence of uncondensed light compounds, a pressure controller on reflux drum vapour outlet line allows venting the gas to the flare. The reflux drum distillate is pumped to the third reactor section. A part is recycled under flow control as reflux to the column. The TAME Fractionator is reboiled by LP Stream in the TAME Fractionator Reboiler. The drain water which may come from the boot of TAME Fractionator Reflux Drum is sent manually to Methanol Drains Drum for further reprocessing in methanol distillation section.

2.4.2.2.4 Third Reactor Section

The Third Reactor is used to increase the isoamylenes conversion since the equilibrium of the main reaction is modified after removal of TAME in the TAME Fractionator. Third Reactor is a fixed bed reactor.

As mentioned above, the TAME Fractionator distillate is pumped. Then it is heated by LP Steam in the Third Reactor Preheater and then fed into Third Reactor. The third reactor inlet temperature is controlled under LP Steam flow.

Third Reactor Resin Trap at third reactor outlet to stop the resin in case of resins carry over. Then, the third reactor effluent is cooled down in the Raffinate Column Feed Air Cooler before entering to the raffinate washing section. The pressure of the third reactor is controlled downstream section by pressure controller located at Raffinate Coalescer inlet. This pressure controller actuates the control valve on raffinate product to storage.

	ADDITIONAL INFORMATION TO THE DEIA REFINERY AND PETROCHEMICAL INTEGRATED DEVELOPMENT (RAPID) PROJECT, PENERANG JOHOR, 2012 TO INCLUDE EURO 5 MOGAS AND OLEFIN TANK UNITS	
	PROJECT DESCRIPTION	

The Defining Drum is used to remove resin fines before resin loading operation during start-up or maintenance. The washing water used for washing resins comes from Cold Condensate Network. Washing water is recycled to expand resins in the Defining Drum in order to remove the resin fines.

2.4.2.2.5 Raffinate Washing Section



The third reactor effluent is further cooled in the Raffinate Column Feed Air Cooler and Raffinate Column Feed Water Cooler and then sent into the Raffinate Washing Column. This column is a sieve tray column where methanol excess removal is achieved with a counter current water stream being recycled from the methanol distillation section under flow control.

The free water in the raffinate product coming out from the Raffinate Washing Column top is trapped in the Raffinate Coalescer. The Raffinate product is then routed to be mixed with TAME product from TAME Fractionator bottom under pressure control. This pressure control system is responsible for controlling the upstream third reactor section pressure (Third Reactor Section).

The composition of the washed Raffinate product is indicated by an online analyser which monitors mainly the concentration of TAME, methanol, reactive iso-olefins ($iC_5=$ and $iC_6=$), and TAA.

A recirculation line (normally no flow) under flow control is foreseen from raffinate product outlet line back to TAME Fractionator inlet during turndown operation. The purpose is to maintain a minimum hydraulic flowrate to feed the Raffinate Washing Column in order to ensure proper operation of the column. This minimum hydraulic flowrate is 60% of the unit design flowrate.

The intermittent drain water coming from the boot of Raffinate Coalescer is

	ADDITIONAL INFORMATION TO THE DEIA REFINERY AND PETROCHEMICAL INTEGRATED DEVELOPMENT (RAPID) PROJECT, PENERANG JOHOR, 2012 TO INCLUDE EURO 5 MOGAS AND OLEFIN TANK UNITS	
	PROJECT DESCRIPTION	

sent to the Methanol Column Feed Drum under level control. The methanol/water mixture at the bottom of Raffinate Washing Column is firstly routed under level control to the Methanol Column Feed Drum. Pressure is maintained by split-range control (Nitrogen/Flare). Then, it is sent to the methanol distillation section.

The recycles water (methanol free) coming from the methanol distillation section is further cooled in Recycled Water Cooler before being sent to Raffinate Washing Column under flow control. A purge is also foreseen to renew the water in the water loop. This purge is sent to Effluent Treatment Plant (ETP) under split-range flow control with the water make-up reset by level control on Methanol column bottom.



2.4.2.2.2.6 Methanol Distillation Section

Before feeding the Methanol Column, the methanol/water mixture is preheated in the Methanol Column Feed/Bottom Exchangers.

Methanol/water separation occurs in Methanol Column. Methanol is recovered at the top section and water at the bottom section. The water from bottom is, mixed with fresh water (under split-range flow control with water purge), cooled down in the Methanol Column Feed/Bottom Exchangers and finally sent to Raffinate Washing Column.

Pressure in Methanol Column is maintained by split-range control (Nitrogen/Flare) on the Methanol Column Reflux Drum. The overhead methanol is first used to preheat the feed of TAME fractionator in the Second Reactor Effluent/Methanol Column Top Exchanger. Then it is fully condensed in the Methanol Column Air Condenser. The recovered methanol is finally sent to the Methanol Column Reflux Drum.

The reflux drum distillate is pumped. One part is recycled under flow control as reflux to the column and the other part is sent as recycled methanol to the Methanol Make-up Surge Drum.

	ADDITIONAL INFORMATION TO THE DEIA REFINERY AND PETROCHEMICAL INTEGRATED DEVELOPMENT (RAPID) PROJECT, PENERANG JOHOR, 2012 TO INCLUDE EURO 5 MOGAS AND OLEFIN TANK UNITS	
	PROJECT DESCRIPTION	



TAA (tertiary amyl alcohol) draw-off from Methanol column is pumped by to the TAME fractionator inlet line, upstream the exchanger. The purpose of this draw-off is to avoid a possible TAA build-up in the Methanol Column, which could ultimately lead to operating problems and column flooding. TAA is then recovered in TAME Fractionator bottom.

The Methanol column is reboiled by LP Stream in the Methanol Column Reboiler under flow control reset by sensitive tray temperature control of the column and acting on the control valve located on condensate outlet line.

2.4.2.2.7 Methanol Make-Up/Drains Section

Fresh methanol make-up is coming from storage (outside battery limit) and is routed to Methanol Make-up Surge Drum. Then fresh methanol make-up is stripped (small packing column integrated to the drum) using nitrogen gas under flow control to reduce oxygen concentration. The stripping gas effluent is sent to the Flare under pressure control. The recycled methanol coming from methanol distillation section is led to Methanol Make-up Surge Drum. Then, methanol mixture (recycled and fresh) is routed to Methanol Guard Pots in order to trap any impurities (mainly nitrogen compounds) present in the fresh feed. Finally, the methanol is sent to the reactors feed sections.

The Methanol Drains Drum is provided to collect all methanol low point drains and the methanol/water effluents produced during the resin loading and unloading operations. The off-specification methanol sent to the Methanol Column Feed Drum for reprocessing. The HC Drains Drum is provided to collect all hydrocarbons from low point drains and during normal operation and intermittent operation as resin unloading operations or start-up. The hydrocarbons can be recycled to the LCN Feed Surge Drum 1440-V-001 or to the TAME Fractionator inlet for reprocessing.

	<p style="text-align: center;">ADDITIONAL INFORMATION TO THE DEIA REFINERY AND PETROCHEMICAL INTEGRATED DEVELOPMENT (RAPID) PROJECT, PENGERANG JOHOR, 2012 TO INCLUDE EURO 5 MOGAS AND OLEFIN TANK UNITS</p>	
	<p style="text-align: center;">PROJECT DESCRIPTION</p>	



2.4.2.2.3 C₅/C₆ Isomerisation Unit (ISOM)

The main sections of ISOM unit are:

1. Sulphur Guard Bed and Feed Drying Section
2. H₂ Make-Up Purification And Drying Sections
3. Isomerisation Reactors Section
4. Stabiliser Section
5. Scrubber Section
6. Dryers Regeneration

2.4.2.2.3.1 Sulphur Guard Bed And Feed Drying Sections

To avoid any potential sulphur contamination on Isomerisation catalyst, Light Hydrotreated Naphtha from Naphtha Hydrotreater Section is first sent in the Sulphur Guard Bed after being preheated against Sulphur Guard Bed Effluent in exchanger. The treated feed is then cooled down against the feed in Sulphur Guard Bed Feed / Effluent Exchanger. Sulphur content is monitored at the inlet and outlet of the Sulphur Guard Bed with an on-line analyser. This cooled treated feed is sent to the Feed Surge Drum under flow control with reset from Feed Surge Drum liquid level. Pressurisation of this drum is ensured by dried H₂ from Hydrogen Dryers with pressure split-range control. In case of pressure increase in the Feed Surge Drum, H₂ will be sent to SGP, or to flare in case of SGP shutdown. Treated feed is then pumped to enter the two Feed Dryers which operate in lead/lag configuration. The composition of the feed, in particular the benzene content, is monitored by on-line analyser at the Dryers inlet. These two Dryers, in which the feed circulates downflow, protect the Isomerisation catalyst from irreversible damage by water. 3 on-line moisture analyser cells are provided, one at the inlet of the dryers, one at the outlet of the lead dryer and one at the outlet of the lag dryer. The dry feed is then routed to Isomerisation Reaction Section. At start-up and during operation at turndown, some isomerate product will be recycled to the Feed Surge Drum to maintain at least 55% minimum of the unit design flowrate in the

	<p style="text-align: center;">ADDITIONAL INFORMATION TO THE DEIA REFINERY AND PETROCHEMICAL INTEGRATED DEVELOPMENT (RAPID) PROJECT, PENGERANG JOHOR, 2012 TO INCLUDE EURO 5 MOGAS AND OLEFIN TANK UNITS</p>	
	<p style="text-align: center;">PROJECT DESCRIPTION</p>	

Isomerisation reaction section.

2.4.2.2.3.2 H₂ Make-Up Purification And Drying Sections

Hydrogen Make-up from HCDU Unit is sent to the Isomerisation Unit under flow ratio control: the ratio between hydrogen and the feed is kept constant by the flow ratio controller acting on the valve at the inlet of the unit. H₂ is then preheated in the H₂ Purification Feed / Effluent Exchanger and further heated in the H₂ Purification Heater. Hot H₂ is then sent to the H₂ Purification Reactor.



Sulphur trapping and carbon dioxides methanation reactions take place in the H₂ Purification Reactor. The reactor effluent is cooled down in the H₂ Purification Feed / Effluent Exchanger, and then further cooled down in H₂ Purification Trim Cooler. CO/CO₂ content is monitored at the inlet and outlet of the H₂ Purification Section with an on-line analyser.

Purified H₂ is then routed to Hydrogen Dryers to remove water from the gas which is extremely detrimental to the Isomerisation's catalyst. 2 on-line moisture analyser cells are provided, one at the outlet of the lead dryer and one at the outlet of the lag dryer.

2.4.2.2.3.3 Isomerisation Reactors Section

Dry Feed from Feed Dryers / Reactors Feed Exchanger. The temperature set point is determined to minimize the duty in First Isomerisation Reactor Feed Heater to reduce the consumption of Medium Pressure steam in this exchanger.

At the outlet of Stabiliser Bottoms / Reactors Feed Exchanger the feed is mixed with dry H₂ channelled from Hydrogen Dryers. Finally, the mixed feed is heated in First Isomerisation Reactor Feed Heater. Medium Pressure Steam flowrate is controlled by the temperature at First Isomerisation Reactor. Medium Pressure steam saturation temperature is



	<p style="text-align: center;">ADDITIONAL INFORMATION TO THE DEIA REFINERY AND PETROCHEMICAL INTEGRATED DEVELOPMENT (RAPID) PROJECT, PENGERANG JOHOR, 2012 TO INCLUDE EURO 5 MOGAS AND OLEFIN TANK UNITS</p>	
	<p style="text-align: center;">PROJECT DESCRIPTION</p>	

reduced by a pressure let down valve to avoid too much temperature difference between the process fluid and the steam in the exchanger.

A small amount of chloriding agent is continuously injected at First Isomerisation Reactor inlet by means of chloriding Agent Injection Pumps in order to maintain the chloride balance on the Isomerisation catalyst. These pumps are calibrated at start-up with Isomerisation feed. Tetrachloroethylene (C_2Cl_4) is the recommended chloriding agent. C_2Cl_4 is fully converted to Hydrogen Chloride (HCl) at Reactors normal operating conditions. Hence lost chloride in the reactor effluent is in HCl form, which is finally converted into NaCl in the Caustic Scrubber. Chloriding agent is stored in chloriding Agent Injection Drum. The drum volume has been calculated for a chloriding agent filling-up every 7 days.

The resulting mixture is routed to First Isomerisation Reactor, where benzene hydrogenation and Isomerisation reactions occur. Benzene hydrogenation is an exothermic reaction and Isomerisation reactions are slightly exothermic. The First Isomerisation Reactor effluent has to be cooled down in First Isomerisation Reactor Feed / Effluent Exchanger tube side before entering the Second Isomerisation Reactor. In Second Isomerisation Reactor, remaining Isomerisation reactions occur. This reaction is equilibrated and the equilibrium is displaced from normal paraffin towards branched paraffin caused by the temperature decrease between the first and the second reactor.

Both First and Second Isomerisation Reactors are mixed phase, downflow reactors, with a single catalyst bed. The Isomerisation Reactors are designed to operate in the lead/lag position or in a single reactor configuration. The pressure in the reaction section is controlled by using a back-pressure controller located on the reactors effluent stream, routed to Stabiliser column. The temperature profile in each reactor is monitored with multiple temperature indicators located across the catalyst beds. The differential temperature between adjacent thermocouples is a measure of the reaction extent, while also indicating the most reactive zone of the

	ADDITIONAL INFORMATION TO THE DEIA REFINERY AND PETROCHEMICAL INTEGRATED DEVELOPMENT (RAPID) PROJECT, PENERANG JOHOR, 2012 TO INCLUDE EURO 5 MOGAS AND OLEFIN TANK UNITS	
	PROJECT DESCRIPTION	

catalyst bed.



The Stabilized Isomerate is treated in the Chloride Guard Bed to prevent any chloride from degrading the isomerate used as a regenerant for the Dryers. At the outlet, the Stabilized Isomerate is cooled down before being routed to the Isomerate Air Cooler to be further cooled down.

2.4.2.2.3.4 Stabiliser Section

Isomerisation reactors effluent is heated and then feeds the Stabiliser column. The purpose of the Stabiliser is to remove HCl, H₂ and to reduce C₄⁻ content in the reactors effluent, while minimizing C₅⁺ hydrocarbon vent losses. Light ends, H₂ and HCl are stripped and sent to Caustic Scrubber.

The Stabiliser overhead is partially condensed in Stabiliser Air Condenser. The outlet temperature is controlled by the speed of 50% of the Stabiliser Air Condenser fans. Condensed Stabiliser overhead enters the Stabiliser Reflux Drum where the vapor phase is routed under pressure control to the scrubber section while the liquid is sent back to the Stabiliser as reflux under flow control with reset from Stabiliser Reflux Drum liquid level. Stabiliser is reboiled with Medium Pressure desuperheated Steam in Stabiliser Reboiler. Medium Pressure Steam flowrate is controlled by the temperature at Stabiliser Reboiler outlet by means of a control valve on the condensates.

Stabiliser bottoms, called Stabilized Isomerate, is cooled down in the Stabiliser Feed / Bottom Exchanger tube side and then routed to the Chloride Guard Bed. After cooling at the outlet of the Chloride Guard Bed, the Stabilized Isomerate is cooled down and routed to the storage. The temperature at the outlet of Isomerate Air Cooler is controlled by the speed of 50% of its fans. A small amount of this product at Isomerate Air Cooler outlet is used as regenerant for dryers (batch operation). This product is also recycled to the Feed Surge Drum at start-up and during operation at turndown, to maintain at least 55% minimum of the unit design flowrate in the Isomerisation reaction section.

 PETRONAS	ADDITIONAL INFORMATION TO THE DEIA REFINERY AND PETROCHEMICAL INTEGRATED DEVELOPMENT (RAPID) PROJECT, PENERANG JOHOR, 2012 TO INCLUDE EURO 5 MOGAS AND OLEFIN TANK UNITS	 INTEGRATED ENVIROTECH
	PROJECT DESCRIPTION	



2.4.2.2.3.5 Scrubber Section

As the gas from the Stabiliser Reflux Drum overhead contains HCl, it might lead to corrosion issues. Consequently it must be treated and water washed before being sent to SGP (or the Fuel Gas System as a secondary destination). These off-gases enter at the bottom of the Caustic Scrubber column and flow up through caustic hold-up and then through the first packing bed. The gas leaving the caustic wash section, saturated by caustic, is washed with water in the top packing section to remove any entrained caustic.

Off-gases are then routed under pressure control to SGP, or to the Fuel Gas System if SGP shuts down. To avoid sending chloride to SGP during a Scrubber upset, the operator can switch the off-gases destination to flare. Water is collected in the chimney tray below the water wash packing section and is recirculated. Water lost to the vent gas leaving the Caustic Scrubber is made-up by fresh water addition, which is cooled Boiler Feed Water.

Boiler Feed Water from Battery Limit is cooled down in Water Make-Up Trim Cooler and injected in the water recirculation loop of the Caustic Scrubber. Caustic soda is recirculated and maintained at 56°C in order to keep caustic soda a few degrees warmer than the gas feed and to avoid potential foaming problems due to any hydrocarbon condensation. This is done by exchanging heat with Low Pressure steam. The required flowrate is control on the condensates. A portion of the circulating caustic is sprayed onto the column walls below the caustic wash packing section to avoid any wet hydrogen chloride corrosion in this part of the Caustic Scrubber. The rest of the circulating caustic is injected above the caustic wash packing section to neutralize the off-gases in counter-current.

As HCl consumes NaOH to produce NaCl, the caustic inventory concentration varies from 10 wt% to 2 wt%. Once the concentration of circulating caustic soda has decreased to 2 wt%, the caustic inventory is drained and sent to Spent Caustic Degassing Drum for degassing before being routed to the Neutralisation Tank. The tower bottom is filled up again

	ADDITIONAL INFORMATION TO THE DEIA REFINERY AND PETROCHEMICAL INTEGRATED DEVELOPMENT (RAPID) PROJECT, PENERANG JOHOR, 2012 TO INCLUDE EURO 5 MOGAS AND OLEFIN TANK UNITS	
	PROJECT DESCRIPTION	



with fresh 10 wt% caustic soda. Operation is performed keeping the caustic circulation. Frequency of caustic inventory replacement is 7 days.

Fresh 10 wt% caustic required is stored at atmospheric pressure in Caustic Make-Up Tank. Concentration of fresh caustic is decreased by mixing the 48 wt% Fresh Caustic from Battery Limit with cooled Boiler Feed Water through the Fresh Caustic Mixer.

2.4.2.2.3.6 Dryers Regeneration

Dryers molecular sieves become saturated with water after a certain period of operating time thus need to be regenerated on a regular basis. Multicell on-line moisture analysers are used to monitor the moisture content of the streams leaving each dryer. All four feed and hydrogen dryers are regenerated one by one using vaporized isomerate as regenerant medium in order to remove water trapped in the molecular sieves. The dryer to be regenerated is isolated from its paired one which is still in service. The regenerant is withdrawn from the isomerate product at the outlet of Isomerate Air Cooler. Regeneration section can also be fed with the unit dry feed. Regenerant is completely vaporized by Medium Pressure desuperheated Steam in Dryers Regenerant Vaporizer. Medium Pressure steam saturation temperature is reduced by a pressure letdown valve to avoid too much temperature difference between the process fluid and the steam in the exchanger. The Steam flowrate is controlled at the vaporizer inlet.

Liquid level in the Vaporizer is closely monitored to avoid liquid carryover to Dryers Regenerant Superheater. Superheated vaporized isomerate flows through the dryer. The hot vapor leaving the dryer is condensed in Dryers Regenerant Air Condenser and Dryers Regenerant Trim Cooler. After flowing through Dryers Regenerant Degasser, the spent regenerant stream is mixed under pressure control with the cooled isomerate product and is routed to storage. The Dryers Regenerant Degasser is a liquid flooded drum, releasing the liquid regenerant effluent on pressure control for mixing with the isomerate product. Any light components which accumulate

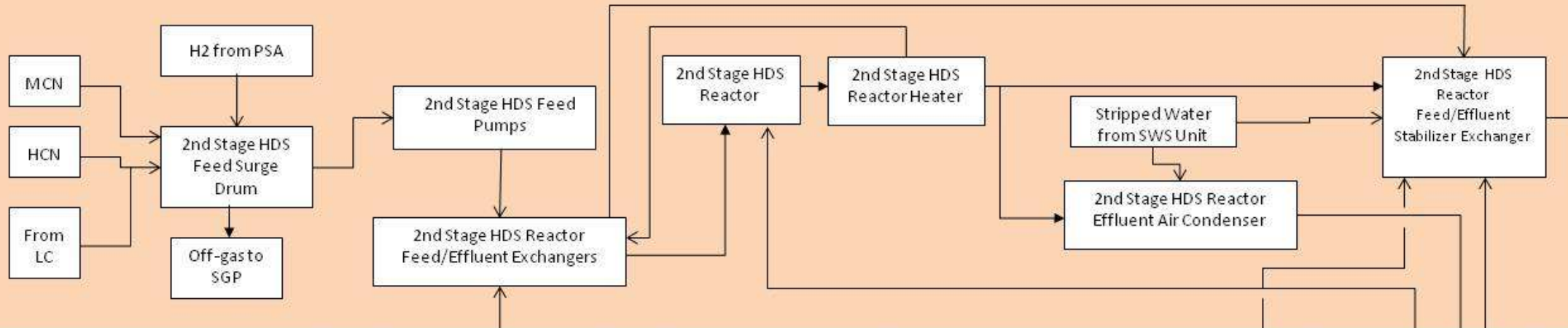
 PETRONAS	ADDITIONAL INFORMATION TO THE DEIA REFINERY AND PETROCHEMICAL INTEGRATED DEVELOPMENT (RAPID) PROJECT, PENERANG JOHOR, 2012 TO INCLUDE EURO 5 MOGAS AND OLEFIN TANK UNITS	 INTEGRATED ENVIROTECH
PROJECT DESCRIPTION		

in the Degasser are purged to flare under liquid level control. Free water collected at the bottom of the Degasser shall be periodically drained to closed drain.



PROJECT DESCRIPTION

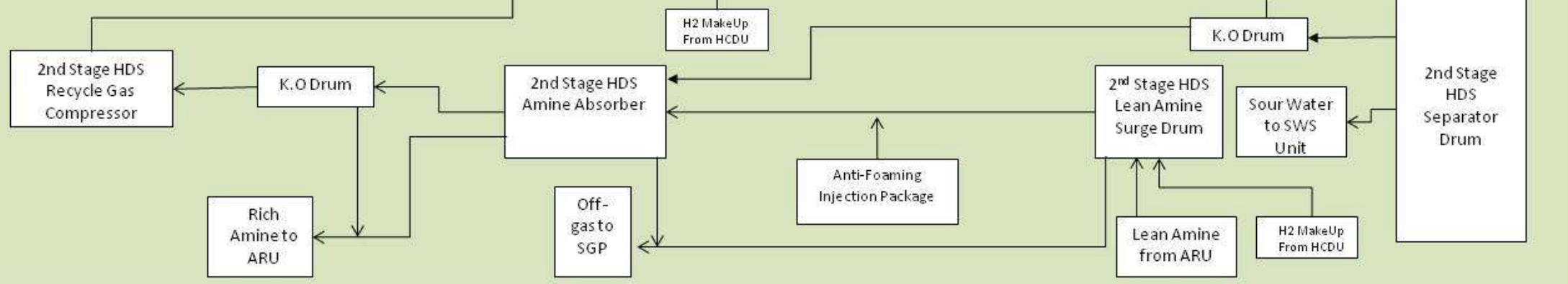
REACTION SECTION



LEGEND

Product

SEPARATION SECTION



ABBREVIATION

- HCN - Heavy Cracked Naphta
- HDS - Hydrodesulphurisation
- HCDU - Hydrogen Collection & Distribution Unit
- K.O - Knockout
- MCN - Medium Cracked Naphta
- PSA - Pressure Swing Adsorption
- SGP - Saturated Gas Plant

STABILIZER SECTION

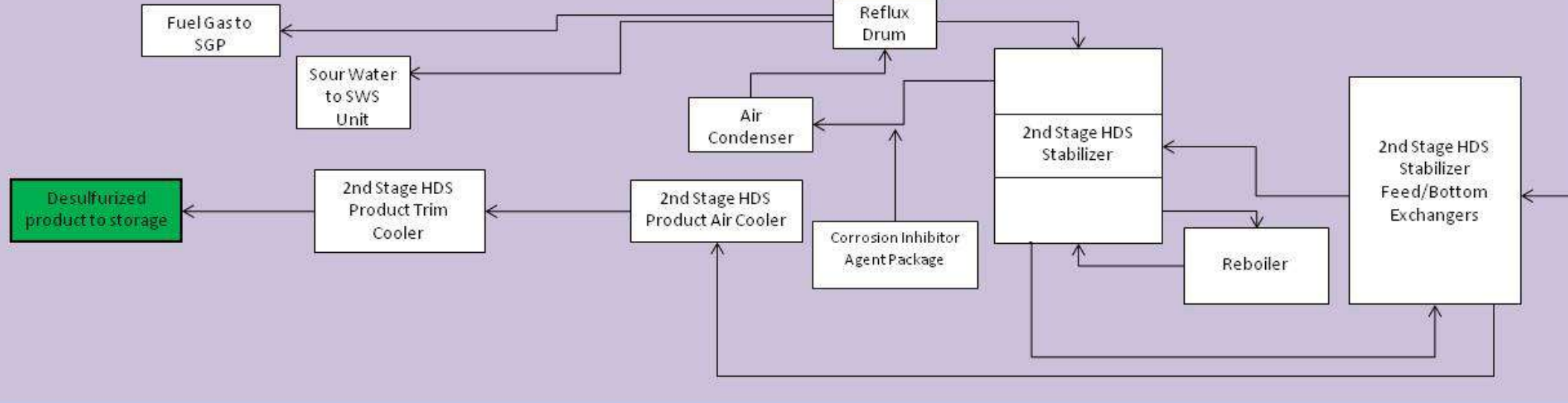


Figure 2-11: Overall Block Flow Diagram for CNHT2 Unit



PROJECT DESCRIPTION

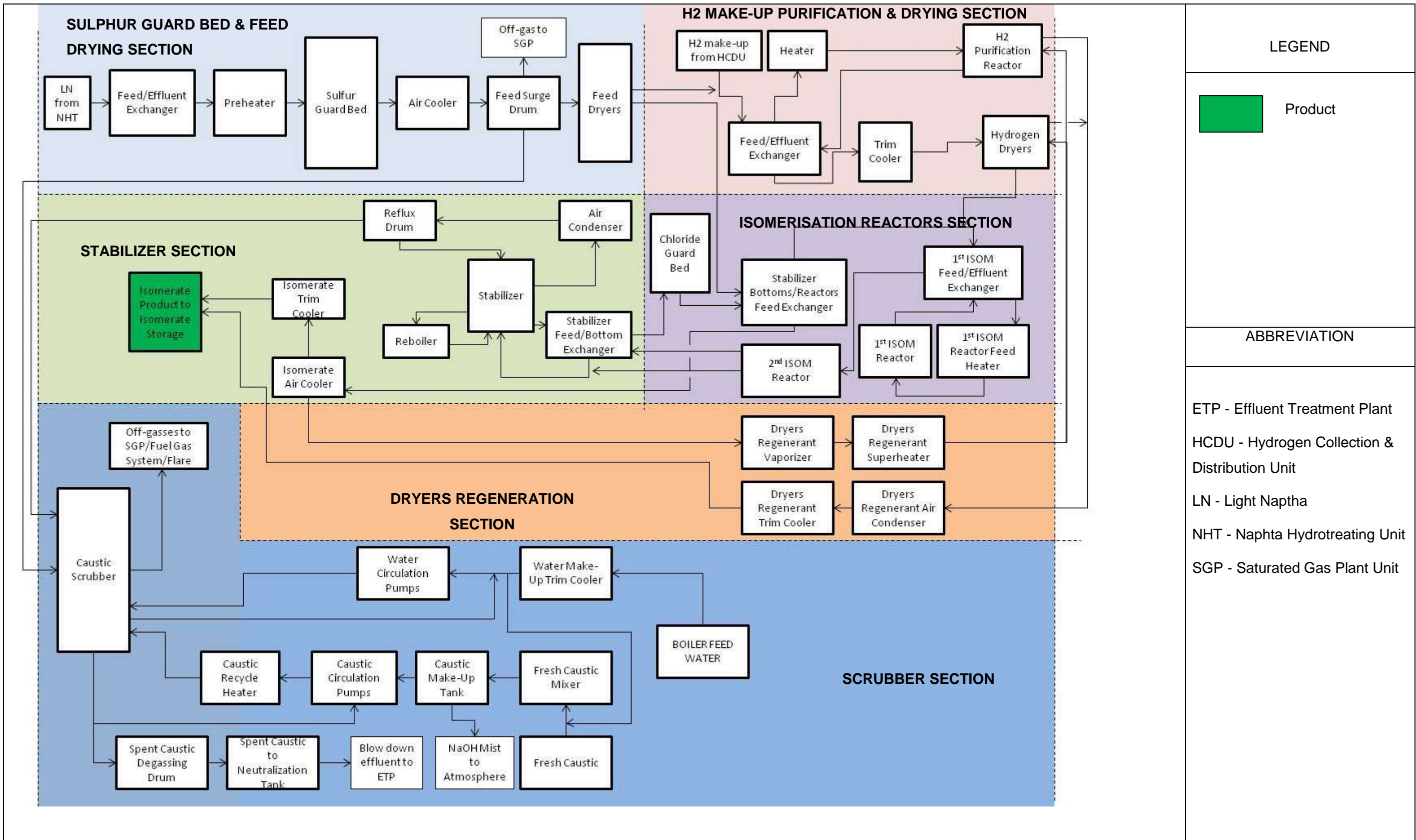


Figure 2-12: Overall Block Flow Diagram for Isomerisation Unit



PROJECT DESCRIPTION

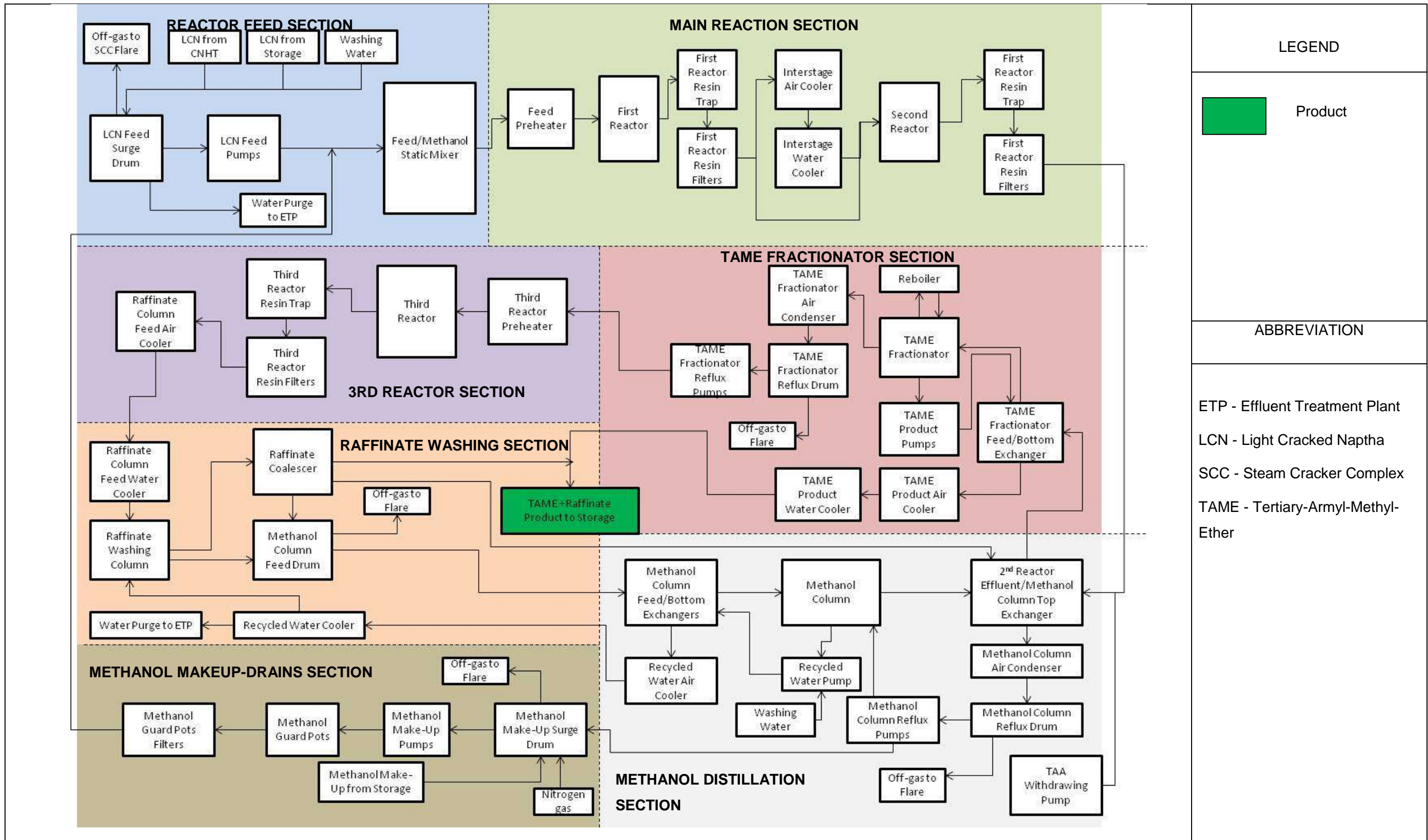




Figure 2-13: Overall Block Flow Diagram for Etherification (TAME) Unit

	ADDITIONAL INFORMATION TO THE DEIA REFINERY AND PETROCHEMICAL INTEGRATED DEVELOPMENT (RAPID) PROJECT, PENERANG JOHOR, 2012 TO INCLUDE EURO 5 MOGAS AND OLEFIN TANK UNITS	
	PROJECT DESCRIPTION	

2.4.2.3 Tankages for Product Storage

The new storages and transfer pumps to cater to the EURO 5 MOGAS products are as follow:



- Two (2) new TAME storage tanks with 7 days total capacity based on TAME Unit design capacity. Transfer pumps are also required for the sending of TAME to the gasoline pool. A stream for recycling off-spec TAME back to the TAME unit will also be added on the discharge of this pump.
- Two (2) new Isomerate storage tanks with 7 days total capacity based on Isomerisation Unit design capacity. Transfer pumps are also required for the sending of isomerate to the gasoline pool.
- One (1) new Medium Cracked Naphta (MCN) storage tank with 3.5 days capacity based on a flow rate of 9,000 Barrel Per Stream Day (BPSD) sent to Naphta Hydrotreating Unit NHT) + 1,000 BPSD sent to Gasoline Pool. New transfer pumps are also required for the transferring of Medium Cracked Naphta (MCN) from this new tank to the gasoline pool.

2.4.2.4 Management of Emissions and Waste

2.4.2.4.1 Air Emission

The air emission for each EURO 5 MOGAS New Units are summarised as follows:

- 1) Cracked Naphta Hydrotreating Unit (CNHT) 2
 - Vapor purge (intermittent), off-gases and fuel gas from the main equipment shall be sent to Saturated Gas Plant (SGP) Unit.
 - The only emission source to the atmosphere is flue gas from the 2nd HDS Reactor Heater.

	<p style="text-align: center;">ADDITIONAL INFORMATION TO THE DEIA REFINERY AND PETROCHEMICAL INTEGRATED DEVELOPMENT (RAPID) PROJECT, PENGERANG JOHOR, 2012 TO INCLUDE EURO 5 MOGAS AND OLEFIN TANK UNITS</p>	
	<p style="text-align: center;">PROJECT DESCRIPTION</p>	

2) Isomerisation Unit

- Vapor purge shall be sent to SGP unit during normal condition and to Refinery Flare during abnormal condition.
- Off-gases shall be sent to Vapor Recovery Unit (VRU) during normal condition and to the Refinery Flare during abnormal condition.
- During abnormal condition, The gaseous emission from pressure safety valves shall also be sent to the Refinery Flare.
- Sodium Hydroxide (NaOH) mist from the Isomerisation Unit shall be vented to the atmosphere.

3) TAME Unit

- During normal condition the off-gases shall be sent to the Saturated Gas Plant (SGP).
- During abnormal condition, gaseous emission from pressure safety valves shall be sent to the Refinery Flare.
- All gaseous emission from the additional storage tanks for EURO 5 MOGAS Unit shall be sent to the Refinery Tank Farm Flare.

The air schematic diagram for EURO 5 MOGAS New Units and Additional Tank Farms is shown in **Figure 2-14**.



PETRONAS

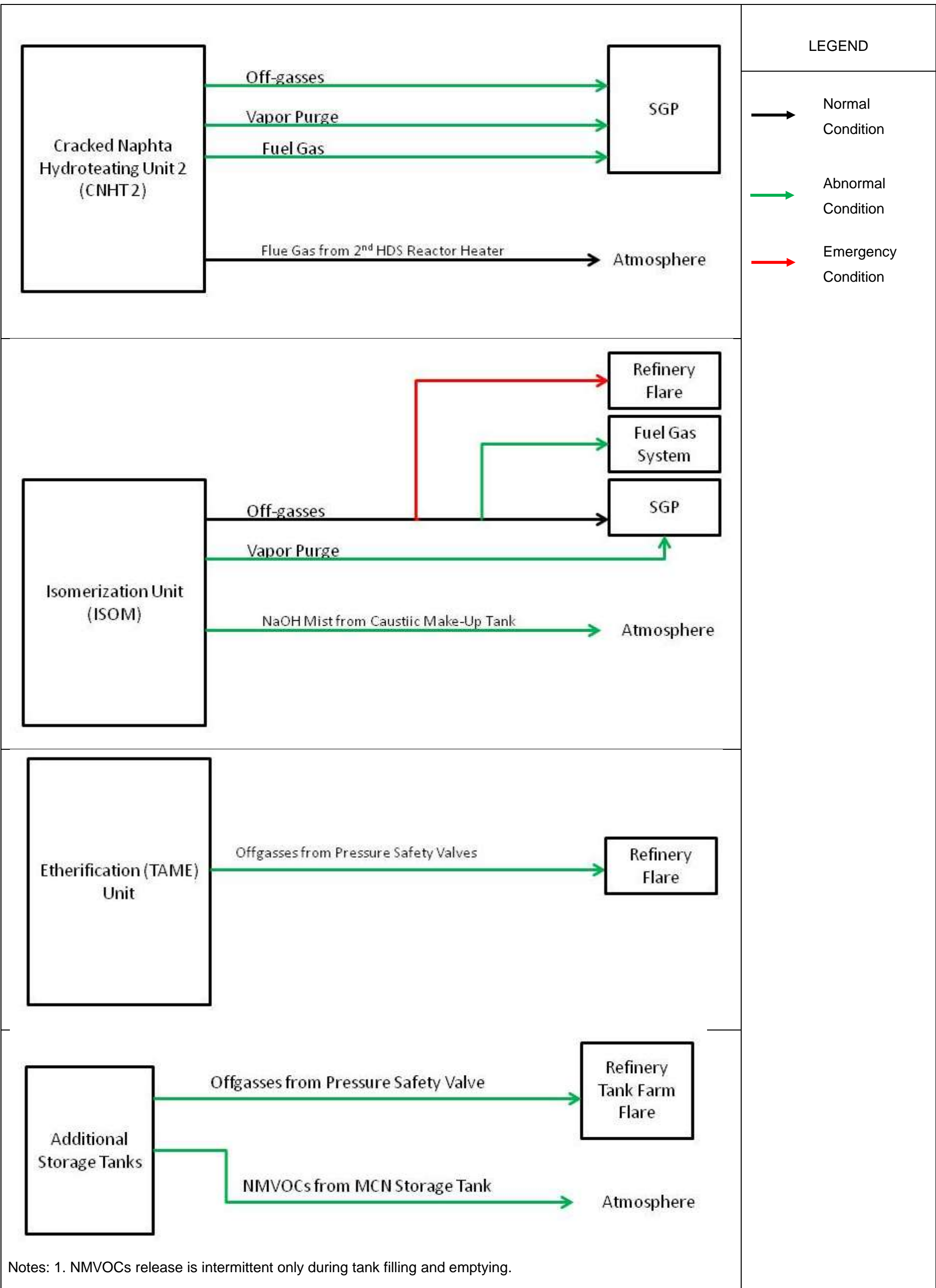




Figure 2-14: Air Emission Schematic Diagram for EURO 5 MOGAS New Units

	<p style="text-align: center;">ADDITIONAL INFORMATION TO THE DEIA REFINERY AND PETROCHEMICAL INTEGRATED DEVELOPMENT (RAPID) PROJECT, PENGERANG JOHOR, 2012 TO INCLUDE EURO 5 MOGAS AND OLEFIN TANK UNITS</p>	
	<p style="text-align: center;">PROJECT DESCRIPTION</p>	

2.4.2.4.2 Wastewater Treatment

The wastewater generated by the new EURO 5 MOGAS unit effluent streams shall be collected in either of the following :

- a) The new units only intermittently generate some purge and blowdown water. All Process wastewater will be collected in the Accidentally Oily Contaminated (AOC) drain or Accidentally Chemically Contaminated (ACC) drain and routed for treatment in the Centralised Effluent Treatment Plant (ETP). Treated effluent from the Centralised ETP will be discharged into the coast via a 1.5 km marine outfall;
- b) Contaminated surface runoff water from the process areas that will overflow to the storm water drains and routed to the storm water basin prior to discharge into the coast.



Details of the discharged treated effluent modelling results are provided in the effluent dispersion study of this report (**Volume 2, Appendix 6**).

2.4.2.4.3 Waste Management

The waste generated from the new EURO 5 MOGAS units shall be managed according to RAPID Refinery & Cracker Complex Waste Management Philosophy. The Scheduled Waste generated during normal operations is only the residue from the Fluidised Cracker Unit of approximately 7,600 MT per year. All other scheduled waste generated are expected to be generated only once in every 3-5 years (during scheduled maintenance and turnarounds). The details of waste management and inventories are provided in the waste management study (**Volume 2, Appendix 5**) of this report.

2.4.2.4.4 Noise Management

Selection of equipment and its noise level will be in compliance with the regulatory requirements set by DOE and DOSH. In order to carry out the

	<p style="text-align: center;"> ADDITIONAL INFORMATION TO THE DEIA REFINERY AND PETROCHEMICAL INTEGRATED DEVELOPMENT (RAPID) PROJECT, PENERANG JOHOR, 2012 TO INCLUDE EURO 5 MOGAS AND OLEFIN TANK UNITS </p>	
	<p style="text-align: center;">PROJECT DESCRIPTION</p>	

assessment and to determine the impact of noise, noise modelling has been carried out to incorporate noise emission from the new units of EURO 5 MOGAS configuration. Details of the noise emission and the modelling results are provided in the noise modelling section of this report (**Volume 2, Appendix 4**).

2.4.2.5 Safety and Health

2.4.2.5.1 Quantitative Risk Assessment (QRA)

It is common practice for all refinery related plants to carry out a Quantitative Risk Assessment to determine the risk of the project to the employees as well as to the surroundings. To carry out the risk assessment and to determine the impact of the new units of EURO 5 MOGAS configuration, a Quantitative Risk Assessment has been carried out. Details of the study are provided in the QRA section of this report (**Volume 2, Appendix 3**).

2.4.2.5.2 Health Aspect

With the inclusion on the new process by the new units of EURO 5 MOGAS configuration, a revised health impact assessment has been made to include the new units. The health impact assessment has been carried based on the results from the air emission modelling. The details and conclusion from the health impact study is provided in the health impact study section of this report (**Volume 2, Appendix 2**).

2.4.2.6 Project Schedule

The project implementation schedule for the new units of EURO 5 MOGAS configuration is as shown in **Table 2.8**.





PROJECT DESCRIPTION

Table 2.8: EURO 5 MOGAS Units Project Schedule

No	Work Description	2016					2017					2018					2019																		
		03	04	05	06	07	08	09	10	11	12	01	02	03	04	05	06	07	08	09	10	11	12	01	02	03	04	05							
1	CNHT 2																																		Ready for Start Up
1.1	FEED																																		
1.2	Tendering																																		
1.3	EPCC																																		
2	ISOM, TAME & ADDITIONAL STORAGE																																		Ready for Start Up
2.1	FEED																																		
2.2	Tendering																																		
2.3	EPCC																																		

Notes: EPCC - Engineering, Procurement, Construction and Commissioning

	<p style="text-align: center;">ADDITIONAL INFORMATION TO THE DEIA REFINERY AND PETROCHEMICAL INTEGRATED DEVELOPMENT (RAPID) PROJECT, PENGERANG JOHOR, 2012 TO INCLUDE EURO 5 MOGAS AND OLEFIN TANK UNITS</p>	
	<p style="text-align: center;">PROJECT DESCRIPTION</p>	

2.4.3 **ADDITIONAL OLEFINS STORAGE**

Additional new olefin storage unit which consists of tanks to store three type of products – Butadiene, Propylene and Ethylene from the Refinery and Cracker complex shall be constructed and installed with the following intentions:

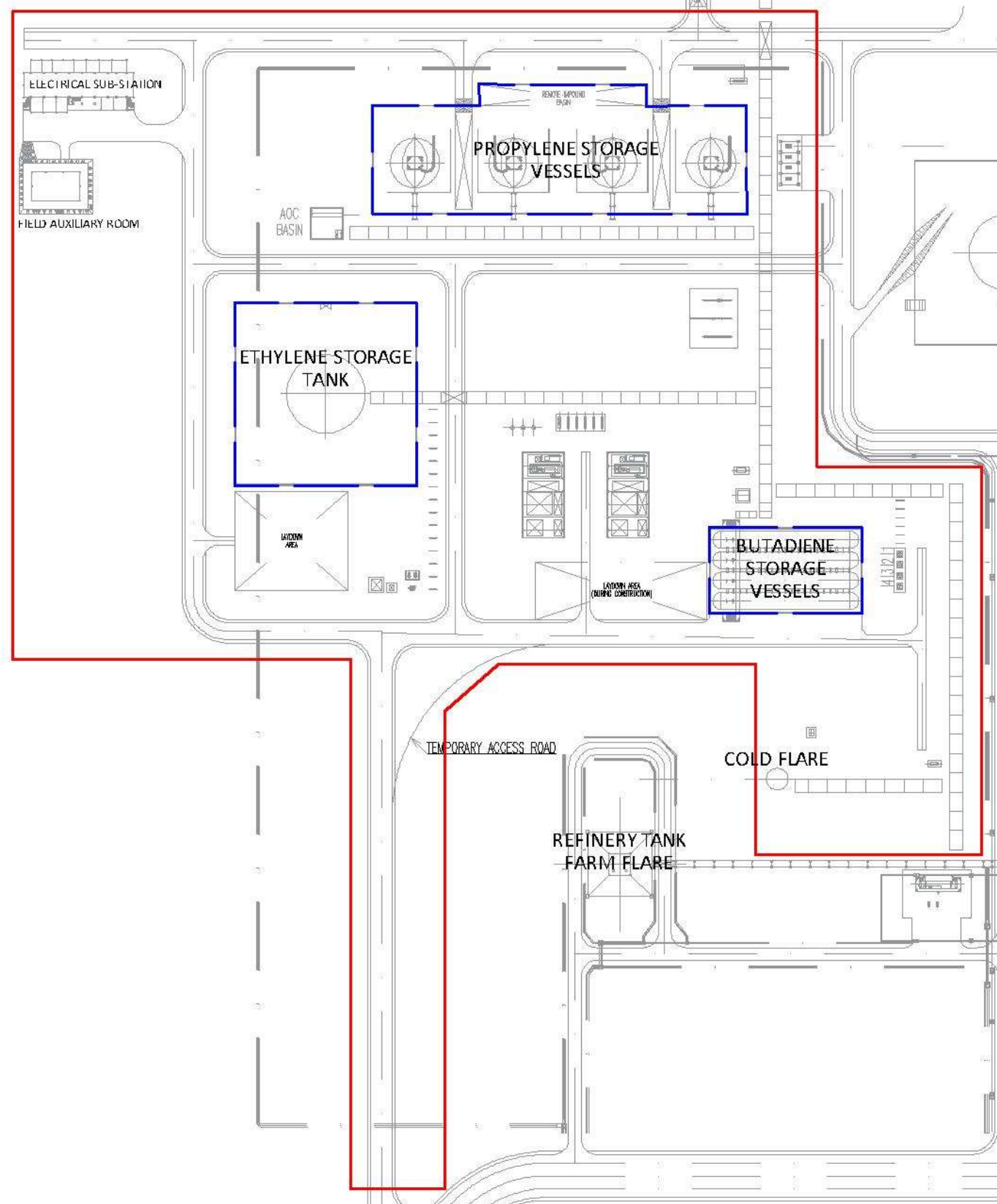
- 1) To manage the inventory of the above mentioned products during plant upsets or interruption and ensure continuous operation of refinery cracker and/or downstream petrochemical plants
- 2) For operation flexibility between olefin producers and users within RAPID complex
- 3) To provide buffer storage prior to exporting by shipment via the Pengerang Deepwater Terminal.

The layout plan for Additional Olefins Storage is shown in **Figure 2-15**.



PETRONAS

PROJECT DESCRIPTION





LEGEND



Additional Olefins Storage Unit Boundary

Figure 2-15: Additional Olefins Storage Layout Plan

	ADDITIONAL INFORMATION TO THE DEIA REFINERY AND PETROCHEMICAL INTEGRATED DEVELOPMENT (RAPID) PROJECT, PENERANG JOHOR, 2012 TO INCLUDE EURO 5 MOGAS AND OLEFIN TANK UNITS	
	PROJECT DESCRIPTION	

2.4.3.1 Olefins Storages Descriptions

The additional Olefins storages consist of the followings:

1. Four (4) of mounded bullets Butadiene storage
2. One (1) Ethylene Storage Tank
3. Four (4) Propylene Storage Spheres



2.4.3.1.1 Butadiene Storage

Additional Butadiene Storage facilities consists of 4 number of butadiene storage vessels, butadiene coolers, butadiene transfer and export pumps, pig launchers / receivers, loading and re-circulation lines and associated utilities.

Current design consists of a line for transferring butadiene from SCC Tank farm to Pengerang Deep Water Terminal (PDWT) storage facilities. Butadiene from SCC tank farm will be received at battery limit by modifying / re-routing line running from SCC tank farm to Pengerang Deep Water Terminal (PDWT) storage facilities. This will be chilled to -4.0°C in a new butadiene coolers to minimize polymerisation / dimerisation and will be received into butadiene storage vessels.

New butadiene loading pumps (2 x 100%) will be used to pump butadiene from storage vessels to ships via Pengerang Deep Water Terminal (PDWT) facilities. A new line will be added from the additional olefins storage area till Pengerang Deep Water Terminal (PDWT) jetty facilities to facilitate butadiene export.

To minimize polymerisation / dimerisation of butadiene product, it is necessary to keep the the export pipeline at cold condition such as < 10°C. This will be achieved by circulating cold butadiene using new butadiene transfer pumps (2 x 100%) through export pipeline and will be received back via line available between SCC tank farm to Pengerang Deep Water

	<p style="text-align: center;">ADDITIONAL INFORMATION TO THE DEIA REFINERY AND PETROCHEMICAL INTEGRATED DEVELOPMENT (RAPID) PROJECT, PENGERANG JOHOR, 2012 TO INCLUDE EURO 5 MOGAS AND OLEFIN TANK UNITS</p>	
	<p style="text-align: center;">PROJECT DESCRIPTION</p>	

Terminal (PDWT) facilities. The circulated butadiene will be sent initially to butadiene cooler where heat gained will be removed and sent to storage vessels. Pigging facilities will be provided all long pipes rundown line from SCC tank farm to additional olefins storage, export pipeline from additional olefins storage to Pengerang Deep Water Terminal (PDWT) jetty, re-circulation line from Pengerang Deep Water Terminal (PDWT) to additional olefins storage.

The block flow diagram for butadiene storage are as follow:



PROJECT DESCRIPTION

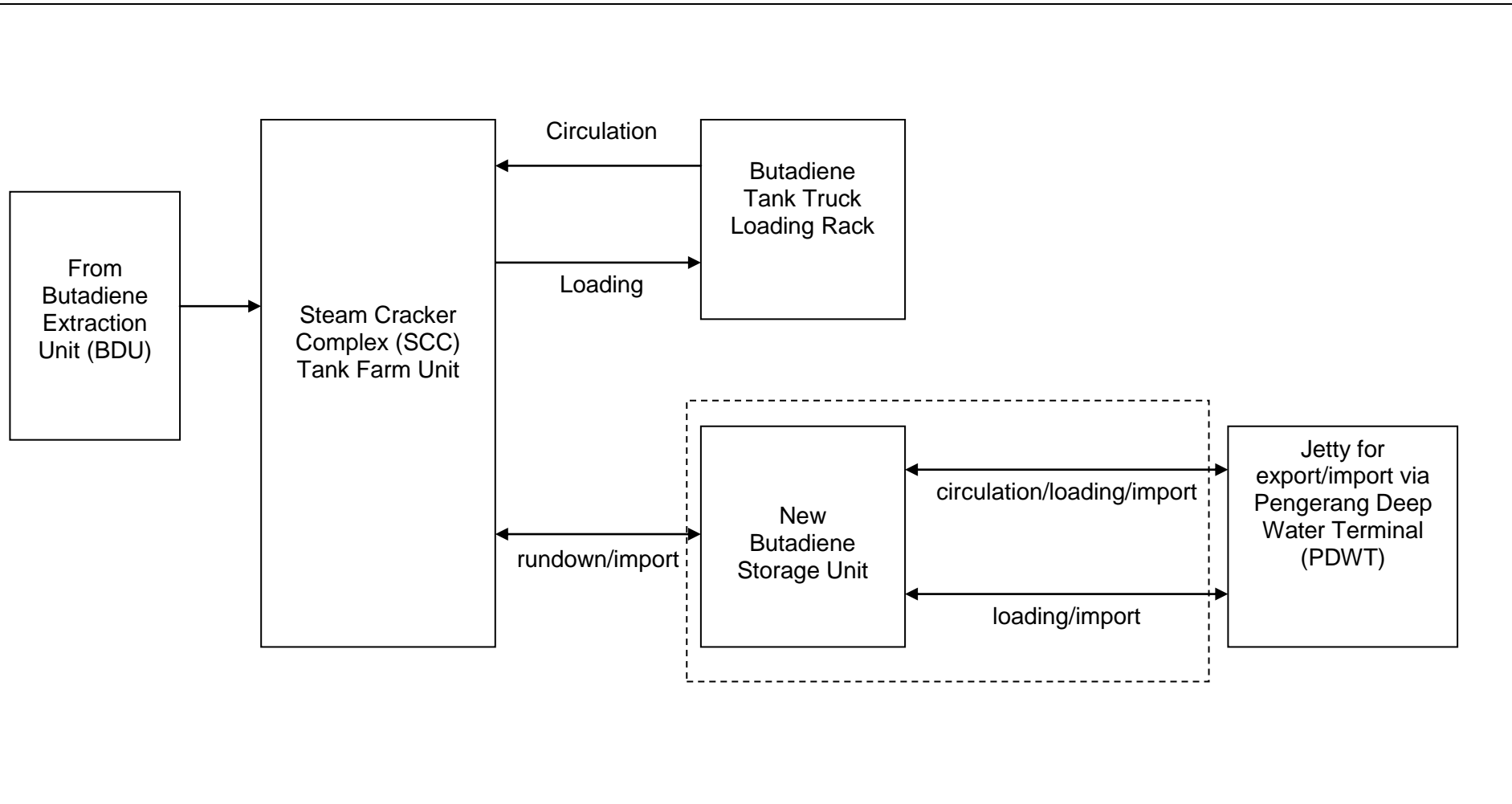




Figure 2-16: Block Flow Diagram for New Butadiene Storage Unit

	<p style="text-align: center;">ADDITIONAL INFORMATION TO THE DEIA REFINERY AND PETROCHEMICAL INTEGRATED DEVELOPMENT (RAPID) PROJECT, PENGERANG JOHOR, 2012 TO INCLUDE EURO 5 MOGAS AND OLEFIN TANK UNITS</p>	
	<p style="text-align: center;">PROJECT DESCRIPTION</p>	

2.4.3.1.2 Ethylene Storage

Additional Ethylene storage facilities consists of one number of Ethylene tank, Ethylene BOG Compression system, ethylene loading pumps and associated utilities required. Cryogenic ethylene product will be received from either Steam Cracker Complex tank farm or Pengerang Deep Water Terminal (PDWT) ethylene storage facilities into a new cryogenic ethylene storage tank. The new cryogenic ethylene storage tank is a full containment, fully refrigerated storage with a working capacity of 12000 MT.

The boil off gas generated will be compressed using new Ethylene Boil Off Gas (BOG) Compressors (3 x 50%) and compressed vapour will be sent to ethylene vapour grid. A back up ethylene liquefaction facility will be added to minimize flaring during events such as ethylene vapour consumers are unable to consume ethylene vapor from BOG compressor. Cold ethylene from new cryogenic ethylene storage tank can be sent to either RAPID ethylene users or Pengerang Deep Water Terminal (PDWT) storage facilities using 2 x 100% new ethylene transfer pump (capacity – 110 t/h). The transfer pump is an intank pump.

The cold ethylene will be received by taking a tie-in (at additional olefins storage battery limit) from the interconnecting pipeline network from RAPID facilities to Pengerang Deep Water Terminal (PDWT) ethylene storage tank. The same interconnecting pipeline will also be used to pump ethylene back to RAPID facilities from ethylene storage tank.

The block flow diagram for ethylene storage are as follow:



PROJECT DESCRIPTION

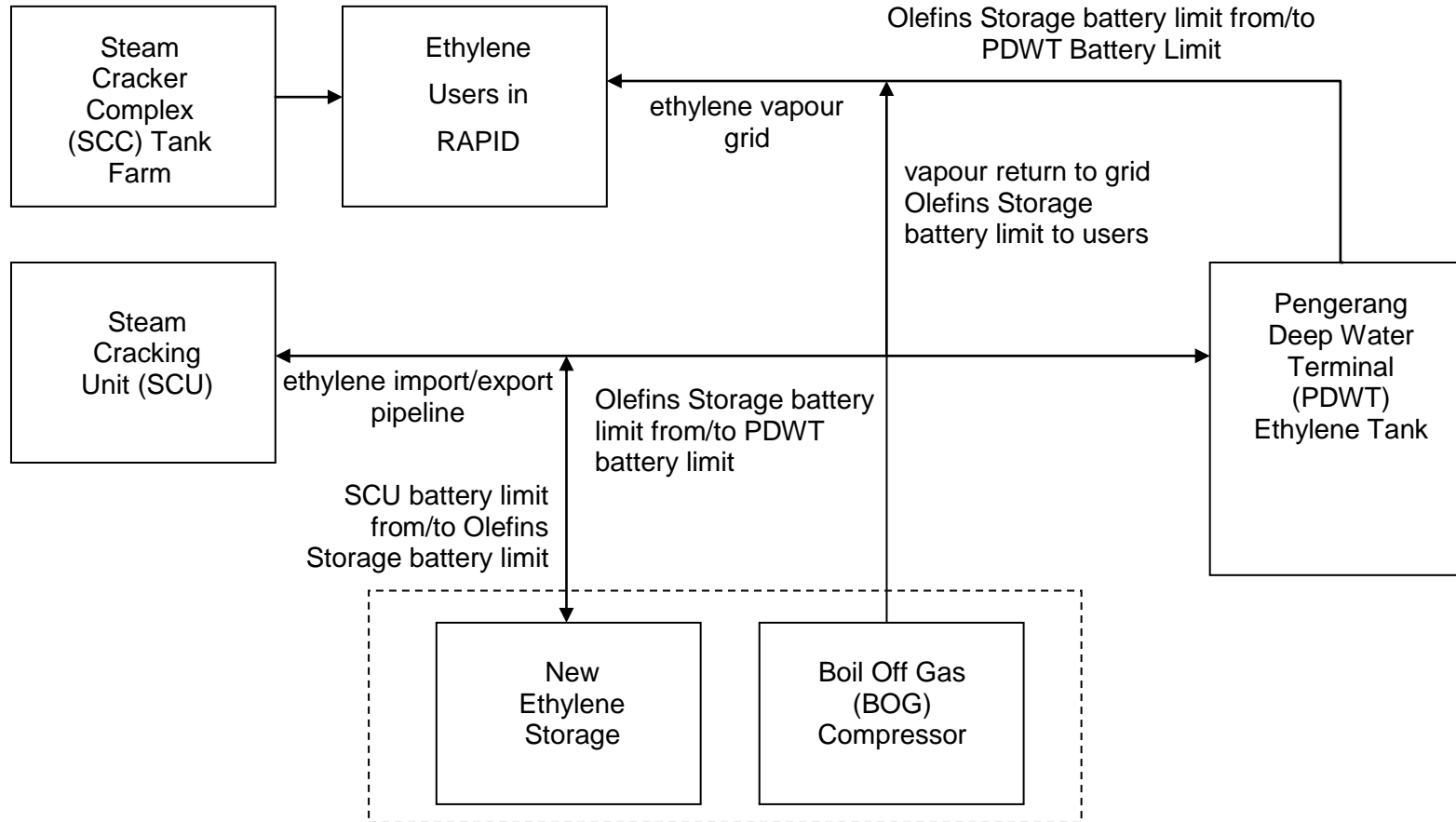




Figure 2-17: Block Flow Diagram for New Ethylene Storage

	<p style="text-align: center;">ADDITIONAL INFORMATION TO THE DEIA REFINERY AND PETROCHEMICAL INTEGRATED DEVELOPMENT (RAPID) PROJECT, PENGERANG JOHOR, 2012 TO INCLUDE EURO 5 MOGAS AND OLEFIN TANK UNITS</p>	
	<p style="text-align: center;">PROJECT DESCRIPTION</p>	

2.4.3.1.3 Propylene Storage

Additional Propylene storage facilities consists of four number of propylene sphere, propylene cooler, propylene loading and unloading facilities and associated utilities required. Warm propylene product (45°C) from RAPID – propylene producers will be received into propylene storage facilities via a new propylene cooler. The propylene is cooled from 45°C to 40°C using cooling water prior to storage. The warm propylene will be received by taking a tie-in (at additional olefins storage battery limit) from the interconnecting pipeline network from RAPID facilities to Pengerang Deep Water Terminal (PDWT) propylene storage tank.

The propylene will be stored in four number of spheres under its own pressure and at ambient temperature. The working capacity of each sphere is 2500 MT and total capacity is 10000 MT. New propylene transfer pumps (2 x 100%) will be installed at Unit 5220 to pump warm propylene from sphere to RAPID propylene consumers (2 x 100%). Similarly, new propylene export pumps (2 x 100%) will be installed to pump warm propylene from sphere to ship via Pengerang Deep Water Terminal (PDWT). A new 10" loading line will be installed from additional olefins storage up to Pengerang Deep Water Terminal (PDWT) jetty in order to export warm propylene. This 10" line also will be used to import warm propylene from ships to the propylene storage via Pengerang Deep Water Terminal (PDWT).

A new refrigerant compressor package will be added to cater butadiene chilling and ethylene liquefaction refrigeration duties. Propylene will be used as refrigerant for this package.

The block flow diagram for new propylene storage are as follow:



PROJECT DESCRIPTION

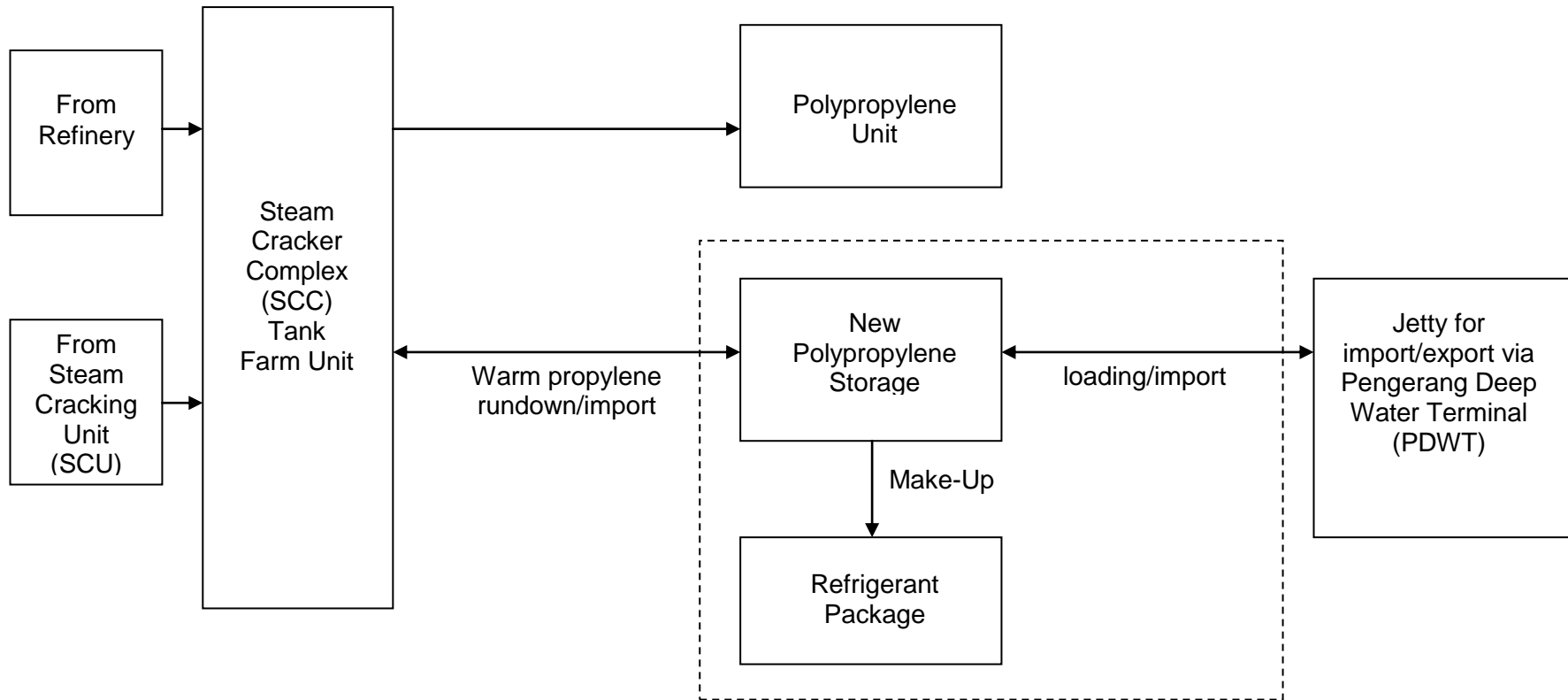




Figure 2-18: Process Flow Diagram for New Polypropylene Storage

	ADDITIONAL INFORMATION TO THE DEIA REFINERY AND PETROCHEMICAL INTEGRATED DEVELOPMENT (RAPID) PROJECT, PENERANG JOHOR, 2012 TO INCLUDE EURO 5 MOGAS AND OLEFIN TANK UNITS	
	PROJECT DESCRIPTION	

2.4.3.1.4 Cooling Water System

An open loop cooling water system is used to supply cooling water (CW) to the users in the Olefin Storage. Cooling tower basin will serve as the cooling water reservoir before cooling water is circulated to the users by cooling water Circulation Pumps through cooling water Supply distribution and cooling water Return collection headers.

Cooling Water Side Stream Filter is installed to remove suspended particles in the circulating cooling water. A blowdown is provided to maintain salts concentration at an acceptable level. Considering the characteristics of the make-up water (treated water from RAPID interconnecting), the number of cycles of concentration is fixed at 6 during normal operation and will be reduced to 4 during make-up water high silica peak period to avoid silica deposit.



Gas detectors will be installed on the plenum area of the cooling towers for detection of potential combustible and toxic gaseous hydrocarbon leaks. Free Residual Chlorine (FRC) and pH analysers will be installed in the cooling water supply and return lines. Chemical injection facilities shall be provided to minimize scaling, fouling and corrosion etc. as necessary.

2.4.3.1.5 Flare & Drains System

The flare system of new storage facilities shall be designed to utilize nearby Refinery Storage Flare system as much as possible.

Considering above requirement, flare loads are segregated as follows:

- a) Cold Flare system (with an operating temperature $\geq -102^{\circ}\text{C}$) – to collect flare/vents from Ethylene Storage Tanks, pumps, BOG liquefaction system etc. compression system dedicated for release from Ethylene storage system
- b) A relatively warm Flare Header (with an operating temperature $\geq -46^{\circ}\text{C}$) – to collect flare/vent release from Butadiene, Propylene

	<p style="text-align: center;">ADDITIONAL INFORMATION TO THE DEIA REFINERY AND PETROCHEMICAL INTEGRATED DEVELOPMENT (RAPID) PROJECT, PENGERANG JOHOR, 2012 TO INCLUDE EURO 5 MOGAS AND OLEFIN TANK UNITS</p>	
	<p style="text-align: center;">PROJECT DESCRIPTION</p>	

storage systems and the Refrigerant compression system.

A dedicated C₃/C₄ Flare header will collect flare/vent release from the Butadiene and Propylene storage systems, and the Refrigerant compression system, and this header will be connected to the existing Refinery Storage Flare system through tie-in with RAPID interconnecting. LP nitrogen will be used for backup flare header purging.



The Closed Drain drum located underground will collect any hydrocarbon released from drains and Thermal Relief Valves (TRVs). The collected liquid is expected to evaporate upon heat gain from atmosphere and routed to the flare system via the Cold Flare Header. Nitrogen connection is available to push the residual liquid from closed drain drum to cold flare KO Drum.

2.4.3.2 Management of Emissions and Waste

2.4.3.2.1 Air Emission

The releases from new units , the Olefins Storage Tankages, will be channelled to the cold flare. The following are the list of Olefin Storage tanks:

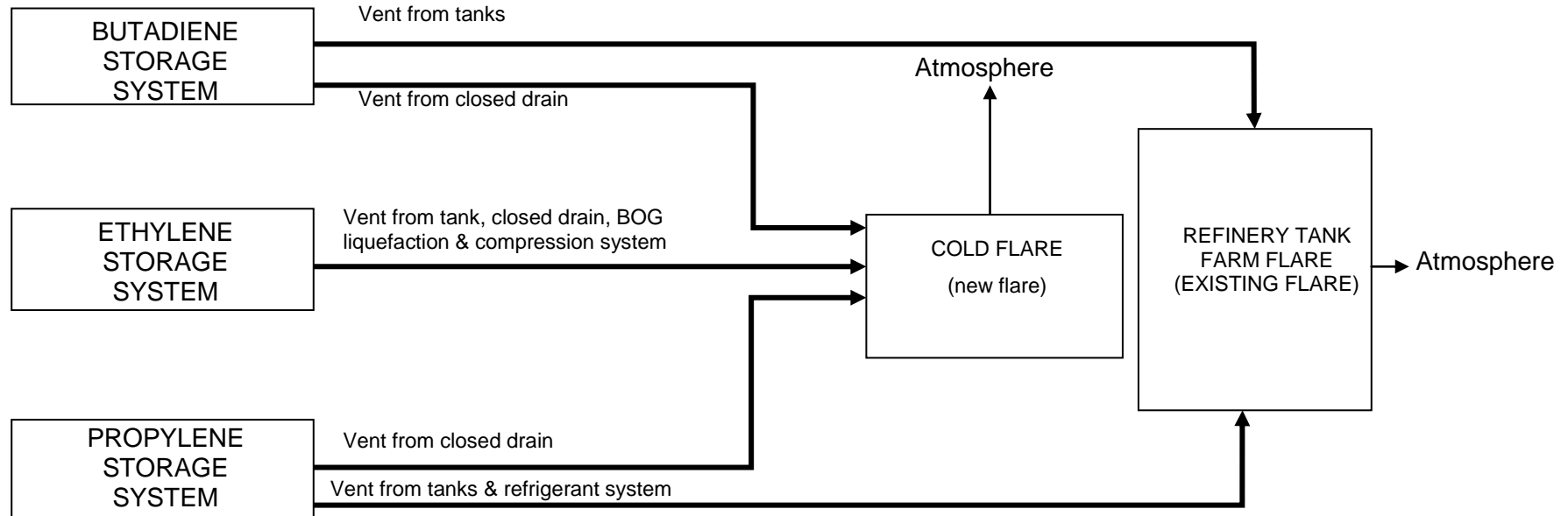
- For Ethylene storage system, the vents released from storage tanks, pumps, BOG liquefaction system and compression system shall be channelled to the cold flare located within the additional olefins storage area.
- For Butadiene Storage System, vents from storage tanks and refrigerant system shall be channelled to the nearby pressurized refinery tank farm flare, outside of the additional olefins storage area. The vents from closed drain for Butadiene storage system shall be channelled to the cold flare.
- Propylene Storage System, vents from storage tanks and refrigerant system shall be channelled to the nearby pressurized refinery tank farm flare, outside of the additional olefins storage area. The vents from closed drain for Propylene storage system shall be channelled to the cold flare.

	<p style="text-align: center;"> ADDITIONAL INFORMATION TO THE DEIA REFINERY AND PETROCHEMICAL INTEGRATED DEVELOPMENT (RAPID) PROJECT, PENERANG JOHOR, 2012 TO INCLUDE EURO 5 MOGAS AND OLEFIN TANK UNITS </p>	
	<p style="text-align: center;">PROJECT DESCRIPTION</p>	

Please refer to **Figure 2-19** for details. Details of the air dispersion modelling results are provided in the Air dispersion study of this report (**Volume 2, Appendix 1**).





PROJECT DESCRIPTION



- Notes: 1. Operating Temperature for Cold Flare is ≥ 102 °C
2. Vents from Butadiene and Propylene Storage shall be collected at flare header with operating temperature of ≥ 46 °C prior to being sent to Refinery Tank Farm Flare
3. All emissions are intermittent during normal condition

→ Normal Condition

Figure 2-19: Air Emission Schematic Diagram for Additional Olefins Storage Tanks

	<p style="text-align: center;">ADDITIONAL INFORMATION TO THE DEIA REFINERY AND PETROCHEMICAL INTEGRATED DEVELOPMENT (RAPID) PROJECT, PENGERANG JOHOR, 2012 TO INCLUDE EURO 5 MOGAS AND OLEFIN TANK UNITS</p>	
	<p style="text-align: center;">PROJECT DESCRIPTION</p>	

2.4.3.2.2 Wastewater Treatment

The wastewater generated by the Additional Olefins Storage Tankages effluent streams shall be collected in either of the following:

- a) Process wastewater effluent collected in the Accidentally Oily Contaminated (AOC) drain or Accidentally Chemically Contaminated (ACC) drain and routed for treatment in the Centralised Effluent Treatment Plant (ETP). The ETP has adequate capacity to accept the additional quantity of effluent. Treated effluent from the Centralised ETP will be discharged into the coast via a 1.5 km marine outfall;
- b) Contaminated surface runoff water from the process areas that will overflow to the storm water drains and routed to the storm water basin prior to discharge into the coastal waters.

Details of the discharged treated effluent modelling results are provided in the effluent dispersion study of this report (**Volume 2, Appendix 6**).



2.4.3.2.3 Waste Management

The waste generated from the Additional Olefins Storage Tanks shall be managed according to RAPID Refinery & Cracker Complex Waste Management Philosophy. All of the scheduled waste generated from Olefin Storage Tank and other Refinery Cracker Units shall be sent to this location for collection and disposal by a DOE licensed 3rd party scheduled waste operator.

The details of waste management and inventories are provided in the waste management of this report (**Volume 2, Appendix 5**).

2.4.3.2.4 Noise Management

Selection of equipment will be based on the regulatory requirement for RAPID development. In order to carry out the assessment and to determine the

	ADDITIONAL INFORMATION TO THE DEIA REFINERY AND PETROCHEMICAL INTEGRATED DEVELOPMENT (RAPID) PROJECT, PENERANG JOHOR, 2012 TO INCLUDE EURO 5 MOGAS AND OLEFIN TANK UNITS	
	PROJECT DESCRIPTION	

impact of noise, noise modelling has been carried out to incorporate noise emission from the Additional Olefins Storage Units. Details of the noise emission and the modelling results are provided in the noise modelling section of this report (**Volume 2, Appendix 4**).

2.4.3.3 Safety and Health

2.4.3.3.1 Quantitative Risk Assessment (QRA)

It is common practice for all petrochemical related plants to carry out a Quantitative Risk Assessment to determine the risk of the project to the employees as well as to the surroundings.

To carry out the risk assessment and to determine the impact of the Additional Olefins Storage Units, a Quantitative Risk Assessment has been carried out. Details of the study are provided in the QRA section of this report (**Volume 2, Appendix 3**).

2.4.3.3.2 Health Aspect

With the inclusion on the new process by the Additional Olefins Storage Units, a revised health impact assessment has been made to include the new processes. The health impact assessment has been carried based on the results from the air emission modelling. The details and conclusion from the health impact study is provided in the health impact study section of this report (**Volume 2, Appendix 2**).

2.4.3.4 Project Schedule

The project implementation schedule for the Additional Olefins Storage Units is as shown in **Table 2.9**.



Table 2.9: Additional Olefins Storage Tanks Project Schedule

No	Work Description	2016					2017												2018												2019										
		08	09	10	11	12	01	02	03	04	05	06	07	08	09	10	11	12	01	02	03	04	05	06	07	08	09	10	11	12	01	02	03	04	05	06	07	08	09	10	
1	FEED	█	█	█	█																																				
2	CONTRACT & TENDERING		█	█	█	█	█	█	█																																
3	BUTADIENE STORAGE																																								
3.1	Detail Design								█	█	█	█	█	█	█	█	█	█	█	█	█	█	█	█	█	█	█	█	█	█	█	█	█	█	█	█	█	█	█	█	
3.2	Construction & Installation									█	█	█	█	█	█	█	█	█	█	█	█	█	█	█	█	█	█	█	█	█	█	█	█	█	█	█	█	█	█	█	
3.3	Commissioning																									█	█	█													
4	ETHYLENE & PROPYLENE STORAGE																																								
4.1	Detail Design								█	█	█	█	█	█	█	█	█	█	█	█	█	█	█	█	█	█	█	█	█	█	█	█	█	█	█	█	█	█	█	█	
4.2	Construction & Installation									█	█	█	█	█	█	█	█	█	█	█	█	█	█	█	█	█	█	█	█	█	█	█	█	█	█	█	█	█	█	█	
4.3	Commissioning																																								
4.3.1	Propylene																																								
4.3.2	Ethylene																																								

Ready for Start Up

Ready for Start Up

Ready for Start Up

3 APPROACH AND METHODOLOGY

3.1 Introduction

This section describes the approaches and methodologies for each particular study to be included in the Additional Information Report as listed below:

- i. Air Dispersion Modelling
- ii. Noise Dissipation Study
- iii. Quantitative Risk Assessment (QRA)
- iv. Effluent Dispersion Modelling
- v. Waste Handling and Management Study
- vi. Health Impact Assessment (HIA)



A summary of the study approach, modelling scenarios, study boundary, assumptions and limitations for each specialised study are tabulated in **Table 3.5**.

3.1.1 Sensitive Receptors



The sensitive receptors shall remain consistent and similar to that as in the approved RAPID DEIA, 2012. The list of sensitive receptors is tabulated below:

Table 3.1: List of Identified Sensitive Receptors

Location (Relative to RAPID)	Sensitive Receptor	UTM Coordinates	
		X Easting	Y Northing
3-5 km west of RAPID	Tg. Pengelih	398618.46	151307.55
0-3 km west of RAPID	Pengelih Naval Base	399769.33	152080.60
0-3 km west of RAPID	Kg. Pengerang	401124.86	150698.62
0-3 km east of RAPID	Kg. Sg. Kapal	409607.91	150060.00
0-3 km east of RAPID	Taman Rengit Jaya	409941.50	149513.82
0-3 km east of RAPID	Kg. Sg. Buntu	411013.64	148437.89
0-3 km east of RAPID	Kg. Bukit Buloh	411122.36	150854.29
3-5 km east of RAPID	Kg. Sg. Rengit	413433.10	150189.62

 PETRONAS	ADDITIONAL INFORMATION TO THE DEIA REFINERY AND PETROCHEMICAL INTEGRATED DEVELOPMENT (RAPID) PROJECT, Pengerang Johor, 2012 to include Euro 5 Mogas and Olefin Tank Units	 INTEGRATED ENVIROTECH
	CHAPTER 3 APPROACH AND METHODOLOGY	

Location (Relative to RAPID)	Sensitive Receptor	UTM Coordinates	
		X Easting	Y Northing
3-5 km east of RAPID	Kg. Bukit Gelugor	413705.74	154218.84
0-3 km north of RAPID	Kg. Lepau	405413.56	153580.42
3-5 km northwest of RAPID	Kg. Pasir Gogok	400529.08	156954.35

	ADDITIONAL INFORMATION TO THE DEIA REFINERY AND PETROCHEMICAL INTEGRATED DEVELOPMENT (RAPID) PROJECT, PENERANG JOHOR, 2012 TO INCLUDE EURO 5 MOGAS AND OLEFIN TANK UNITS	
	CHAPTER 3 APPROACH AND METHODOLOGY	

3.2 AIR DISPERSION MODELING



The description of the air dispersion modelling study for this Additional Information Report shall cover:

- i. Scope of Study
- ii. Applicable Regulatory Framework
- iii. Study Approach and Methodology
- iv. Identification of Sensitive Receptors
- v. Modelling Scenario
- vi. Model Setup

3.2.1 Scope of Study

In this Additional Information study, the scope of work focuses on the updated and latest available information of the Refinery & Cracker Complex. Among the scope of works are;

- a) Identify new and update exiting sources of air emissions in the refinery complex;
- b) To assess the impacts of these changes by modelling using the same AERMOD model.
- c) To assess the latest generated results with the regulatory and/or guideline limits to determine the acceptance level. In the event of breaches of limits and/or guideline values, modifications of project design and/or process parameters for the contributing packages and its units within the refinery complex will be proposed as mitigation measures;
- d) To propose mitigation measures to ensure that the residual impacts after implementation of the mitigation measures do not pose short- and long-term adverse impacts to the physical and human environment
- e) To inventorise greenhouse gases emissions from the packages in the refinery based on Greenhouse Gas Inventory Tier One methodology.

	ADDITIONAL INFORMATION TO THE DEIA REFINERY AND PETROCHEMICAL INTEGRATED DEVELOPMENT (RAPID) PROJECT, PENERANG JOHOR, 2012 TO INCLUDE EURO 5 MOGAS AND OLEFIN TANK UNITS	
	CHAPTER 3 APPROACH AND METHODOLOGY	

3.2.2 Applicable Regulatory Framework

The regulatory framework for stack emissions which is the Emission Limits for Refinery Industry Specified in RAPID DEIA Conditions of Approval August 27, 2012 and the Malaysian Ambient Air Quality Guidelines (DOE, 2014) will be referred to in this Additional Information Report.

However, the comparison of the ambient ground level concentration will be made against the Malaysia Ambient Air Quality Standard, 2013 and the ambient compliance limit will be in reference to the Interim Target 2020.

3.2.3 Study Approach and Methodology



As in the RAPID DEIA 2012, this Additional Information air dispersion study was conducted in accordance with the United States Environmental Protection Agency (USEPA) Guideline on Air Quality Models (GAQM; as incorporated in Appendix W of 40 CFR Part 51) with AERMOD dispersion model.

3.2.4 Identification of Sensitive Receptors

Please refer to **Section 3.1.1**. Sensitive receptors does not include international boundaries.

3.2.5 Emission Sources

The air dispersion modelling will be modelled based on the air pollution control system implemented in the project. The data input is corrected based on the detail design data except for the new units which is currently still front end engineering hence using the FEED data.

 PETRONAS	ADDITIONAL INFORMATION TO THE DEIA REFINERY AND PETROCHEMICAL INTEGRATED DEVELOPMENT (RAPID) PROJECT, PENGERANG JOHOR, 2012 TO INCLUDE EURO 5 MOGAS AND OLEFIN TANK UNITS	
	CHAPTER 3 APPROACH AND METHODOLOGY	

3.2.6 Modelling Scenarios

The modelling scenarios for this Additional Information Report will consist of normal and abnormal scenario based on the actual specification design. The modelling is basically cover the followings:

- Individual emissions from the new process units and tank farms
- Cumulative emissions from RAPID Refinery and Steam Cracker Complex (SCC)
- Cumulative emissions from RAPID Complex which include emission sources from PCP, utilities and Petrochemical Complex.
- Abnormal scenario is based only one failure event at a time, or based on the worst-case pollutant load released from a selected failure event.
- Emergency is based on full flare load based on one failure event at a time but dispersion is based on the worst/highest flare load.

3.2.7 Model Setup

The latest version of AERMOD which is USEPA Version 15181 was used in this Additional Information Report. As described in the approved RAPID DEIA 2012, AERMOD is a refined dispersion model for simple and complex terrain for receptors within 50 km of a modelled source. AERMOD is a steady-state plume model. In the stable boundary layer (SBL), it assumes the concentration distribution to be Gaussian in both the vertical and horizontal planes. In the convective boundary layer (CBL), the horizontal distribution is also assumed to be Gaussian, but the vertical distribution is described with a bi-Gaussian probability density function (pdf). Additionally, in the CBL, AERMOD treats “plume lofting,” whereby a portion of plume mass, released from a buoyant source, rises to and remains near the top of the planetary boundary layer (PBL) before becoming mixed into the CBL. AERMOD also tracks any plume mass that penetrates into the elevated stable layer, and then allows it to re-enter the boundary layer when and if appropriate. For sources in both the CBL and the SBL, AERMOD treats the enhancement of lateral dispersion resulting from plume meander. In case of terrain effect especially two most dominant mountains which are Bukit Pengerang

and Bukit Pelali, AERMOD incorporates current concepts about flow and dispersion in complex terrain. Where appropriate the plume is modelled as either impacting and/or following the terrain, thus AERMOD removes the need for defining complex terrain regimes. All terrain is handled in a consistent and continuous manner while considering the dividing streamline concept in stably stratified conditions.

3.2.8 Meteorological Data

Accurate air quality modelling is highly dependant on the quality of the meteorological and emission data used. Consequently, the best available and most representative data was used to allow for minimal margin for error in the modelling. Three years of the latest meteorological data, year 2012 to 2014 generated by the Mesoscale Meteorological Model (MM5) for the project site was used in the modelling assessment. The AERMET meteorological pre-processor was used to process the data required for AERMOD. The annual windrose of the project site was generated and shown below.

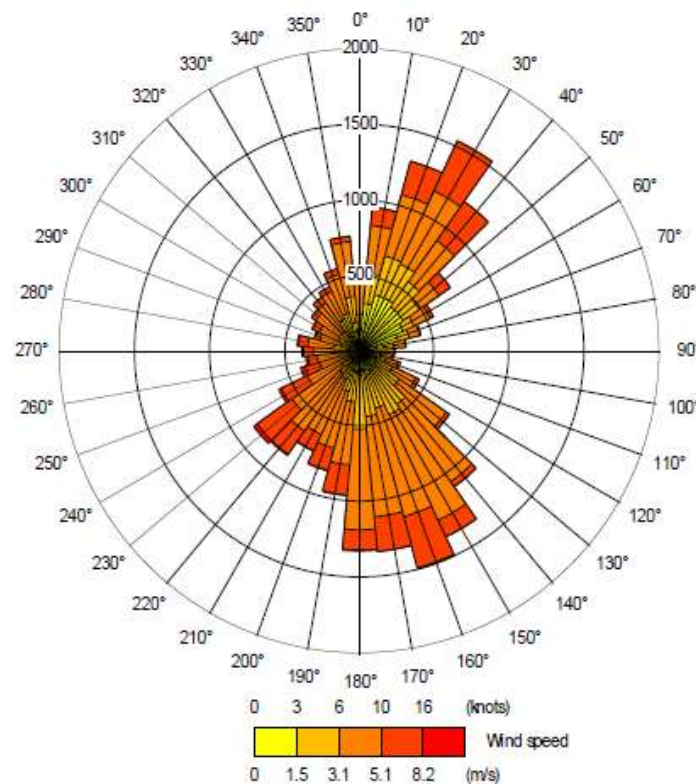




Figure 3-1: Annual Winrose Pattern of the Project Site

	ADDITIONAL INFORMATION TO THE DEIA REFINERY AND PETROCHEMICAL INTEGRATED DEVELOPMENT (RAPID) PROJECT, PENERANG JOHOR, 2012 TO INCLUDE EURO 5 MOGAS AND OLEFIN TANK UNITS	
	CHAPTER 3 APPROACH AND METHODOLOGY	

3.3 NOISE DISSIPATION STUDY

Noise is a potential concern for this proposed project, and in particular at locations of close proximity to residential communities. This is typically at the RAPID northern boundary. Impact from the Refinery Plant operations shall be addressed in this Additional Information Report.

3.3.1 Scope of Study

The noise study shall include the following scope:

- i. To review baseline noise monitoring data undertaken in October 2012 and/or current pre-construction noise climate at identified monitoring locations;
- ii. To review the approved RAPID DEIA, 2012 conditions (Approved Noise Limits);
- iii. To undertake noise modelling in respect to the project operations;
- iv. To assess noise impact of proposed project to surrounding environment particularly to the identified surrounding receptors and to list these receptors; and
- v. Documentation and reporting

3.3.2 Applicable Regulatory Framework

Permissible Noise Level/Limit at RAPID Boundary and Sensitive Noise Recipient at its surrounding shall be established in reference to the approved Overall RAPID DEIA, 2012 Approval Limit (from first and revised approval) and also “Planning Guidelines for Environmental Noise Limit and Control”, published by Department of Environment Malaysia (2007).

A review will be made on Baseline Noise Level measured at nearest Sensitive Recipient (which will remain around the RAPID Boundary) to determine whether it meets the limits as in the condition of approval for the approved Overall RAPID DEIA, 2012 (Please refer to **Table 3.2**).

Table 3.2 Approved Noise Limits (RAPID DEIA, 2012) (Rev. on 7 January 2013)

RAPID Project Boundary	Maximum Permissible Sound Level (dB(A)) From 7.00 am until 10.00 pm	Maximum Permissible Sound Level (dB(A)) From 10.00 pm until 7.00 am
Northern Boundary of the Project Area	60 dB(A)	50 dB(A)
Southern Boundary of the Project Area	70 dB(A)	60 dB(A)
Eastern Boundary of the Project Area	70 dB(A)	60 dB(A)
Western Boundary of the Project Area	60 dB(A)	50 dB(A)



In the event the noise limit is not suitable, recommendations will be made for suitable modifications/ mitigation measures to ensure that the limits are met in accordance to the DOE guidelines.

3.3.3 Study Approach and Methodology

An overview of the technical approach proposed for the noise dissipation study are summarised as follows:

- Individual noise modelling for the new process units and tank farms
- Cumulative noise modelling for the RAPID Refinery and Steam Cracker Complex (SCC)
- Cumulative noise modelling for RAPID Complex which include emission sources from PCP, utilities and Petrochemical Complex.



Environmental noise modelling shall be undertaken in accordance to Acoustics-Attenuation of Sound during Propagation Outdoors - General Method of Calculation (ISO 9613-Part 2: 1996). Assessment shall be carried out in accordance to Planning Guidelines for Environmental Noise Limit and Control”, published by Department of Environment Malaysia (2004), PETRONAS Technical

	ADDITIONAL INFORMATION TO THE DEIA REFINERY AND PETROCHEMICAL INTEGRATED DEVELOPMENT (RAPID) PROJECT, Pengerang Johor, 2012 TO INCLUDE EURO 5 MOGAS AND OLEFIN TANK UNITS	
	CHAPTER 3 APPROACH AND METHODOLOGY	

Guideline on Noise Control (PTS 31.10.00.31) and Method of Rating Industrial Noise Affecting Mixed Residential And Industrial Areas (BS 4142: 1997).

The methodologies for the noise study for each process unit are as follows:

- Review of drawings (site plans, plant layouts, etc.) and equipment specifications, equipment of respective process units. Physical locations of each noise source (equipment, major gas lines, etc.) shall be represented into a spatial model. Noise sources and physical buildings, storage tanks, etc. will be built as 3-D spatial model and sound power levels for noise source will be established (noise data sheets, or estimated from semi-empirical algorithms based on ratings, or alternatively from measured database).
- Calculations in accordance to ISO 9613-2 Acoustics-Attenuation of Sound during Propagation Outdoors Part 2: General Method of Calculation.
- Noise modelling using Cadna-A Industrial Noise Modelling Software Version 3.7.123 from Datakustik.
- Sound pressure levels (SPL) will be calculated based on sound power levels (SWL) of sources, with geometrical propagation, distance to receivers, reflection of large surfaces, ground effects and atmospheric sound attenuation, etc. Screening from large vessels, buildings and barriers (man-made or natural) shall be included in the modelling. Wind effects shall be examined in a sensitivity analysis. Calculations will be based on cumulative effects of multiple noise sources, typically all rotating equipment, power generation equipment and process equipment, major pipe lines and valves (depending on noise & equipment data available).
- Sound power levels (SWL) and the resulting sound pressure levels (SPL), atmospheric attenuation, shielding loss, etc. are frequency dependent. Calculations shall therefore be undertaken in octave band centre frequencies (63 Hz to 8000 Hz). Final results shall be reported on overall A-weighted dB(A) as required for human impact and community response assessment.
- Repeat runs shall be undertaken based on specific scenarios with flares where appropriate.

	ADDITIONAL INFORMATION TO THE DEIA REFINERY AND PETROCHEMICAL INTEGRATED DEVELOPMENT (RAPID) PROJECT, Pengerang Johor, 2012 TO INCLUDE EURO 5 MOGAS AND OLEFIN TANK UNITS	
	CHAPTER 3 APPROACH AND METHODOLOGY	

The approach for the noise study for the cumulative RAPID Refinery & SCC are as follows:

- All process units shall be deemed operational simultaneously, with all noise sources from each respective process units included in the combined noise modelling.
- Noise contours shall be developed for cumulative noise propagation from all related process units in simultaneous operations.

3.3.4 Noise Sources



The noise models are dependent on equipment noise emission at source.

Noise data from equipment data sheets shall be used where available. In the absence of noise data sheets, equipment sound pressure levels / sound power levels shall be based on maximum permissible noise limits stipulated for each equipment type in the Petronas Technical Standard (PTS) which are used in the process units' design.

3.3.5 Modelling Scenarios

The scenarios that will be considered for the purpose of the noise modelling are as follows:

- Scenarios for “Normal” operations that will be modelled as follow:
 - Individual Process units operating on its own Combined Process Unit (all 5 processes) operating simultaneously; and
 - Combined Process Units above repeated with worst case prevailing wind condition.
- “Abnormal” conditions for the Combined Process Units scenario with flaring (emergency requiring the utilization of the flare stack).

	ADDITIONAL INFORMATION TO THE DEIA REFINERY AND PETROCHEMICAL INTEGRATED DEVELOPMENT (RAPID) PROJECT, PENERANG JOHOR, 2012 TO INCLUDE EURO 5 MOGAS AND OLEFIN TANK UNITS	
	CHAPTER 3 APPROACH AND METHODOLOGY	

3.3.6 Noise Model

Noise contour shall be generated from the noise modelling using the Cadna- A: Industrial Noise Modelling Software from Datakustik.

Noise propagation calculations in the software are undertaken in accordance to ISO 9613: Acoustics-Attenuation of Sound during Propagation Outdoors. Noise sources shall be represented within the noise model built within the software. The modelling works will be repeated for respective process units.

3.3.7 Baseline Noise Measurement and Assessment



A summary of the previous baseline noise measurements are provided below:

- Previous DEIA and Environmental Management Plan were based on 25 monitoring locations.
- Monitoring locations included at Noise Sensitive Recipients situated around the RAPID Boundary, at/adjacent RAPID Boundary and within the RAPID Boundary.
- Current Planning and Design review suggests baseline assessment may be reduced to monitoring locations at/adjacent to RAPID Boundary and remaining Sensitive Recipients situated around the project (viz. Kg. Lepau).
- Assessment shall be made to establish the Permissible Noise Limit, if required; and impacts to the Sensitive Recipients situated around the project shall be further assessed.

3.3.8 Assumptions

The technical assumptions applied on the noise study are:

- Noise sources for equipment shall be modelled as point sources. Equipment located within enclosures (if confirmed) shall be modelled with enclosures with intake/ discharge sources.



	ADDITIONAL INFORMATION TO THE DEIA REFINERY AND PETROCHEMICAL INTEGRATED DEVELOPMENT (RAPID) PROJECT, PENGERANG JOHOR, 2012 TO INCLUDE EURO 5 MOGAS AND OLEFIN TANK UNITS	
	CHAPTER 3 APPROACH AND METHODOLOGY	

- Pipes shall be modelled as line sources.
- Where appropriate power houses etc. shall be modelled as plane sources.
- Unless advised otherwise in the Acoustics Induced Vibration (AIV) Study (by others), pipes and valves are assumed not to have AIV noise emissions.
- Flares shall be represented with an assumed noise emission levels i.e. not exceeding 115 dBA as per RAPID design specification in accordance to Petronas Technical Standards Noise Control PTS 31.10.00.31.
- Open structures and platforms where equipment is located assumed to be acoustically transparent. Large buildings and storage tanks shall be included with shielding and diffraction effects represented.
- Process units and equipment are assumed to be operating continuously (day and night). Assessment shall be done based on day and night time criteria and baseline levels.
- The noise model does not include low frequency (inaudible sound). Noise data are A-weighted across audible sound frequency range (63 Hz to 8000 Hz).

3.3.9 Limitations

Typical limitations in noise modelling for this project are as follows:

- Accuracy of noise predictions and assessment is dependent on accuracy and level of information relating to noise emissions of equipment proposed for the process units. Conservative assumptions shall be made based on the maximum permissible noise levels for respective equipment types stipulated in the RAPID Project Brief.
- Vibration (ground borne vibrations and airborne low frequency sound induced vibrations) is not considered in the Work Scope. Ground borne vibrations is not anticipated to be an issue of concern as the process units do not generate significant ground borne vibrations.
- Potential noise generation (humming) from high voltage power lines from power lines are not considered in this Additional Information Report which should be assessed in power station and distribution project.

	ADDITIONAL INFORMATION TO THE DEIA REFINERY AND PETROCHEMICAL INTEGRATED DEVELOPMENT (RAPID) PROJECT, PENERANG JOHOR, 2012 TO INCLUDE EURO 5 MOGAS AND OLEFIN TANK UNITS	
	CHAPTER 3 APPROACH AND METHODOLOGY	

3.4 QUANTITATIVE RISK ASSESSMENT (QRA)

Quantitative Risk Assessment (QRA) is the application of methodology to produce a numerical representation of the frequency and extent of a specified level of exposure or harm, to specified people or the environment, due to the operation of the proposed refinery plants under this Additional Information Report which is an update of the earlier approved RAPID DEIA, 2012. The objective of this study is to analyse the risks to the surrounding areas due to the operation of the new refinery processes units.

3.4.1 Scope of Study



Quantitative Risk Assessment (QRA) is conducted in order to meet the following primary objectives for the Additional Information Report:

- i. To identify the major risk associated with the new refinery processes units under the scope of this Additional Information Report;
- ii. To determine hazards/ risks due to possible accident scenarios which will lead to fire, explosion or toxic release at the new refinery processes and units under the scope of this Additional Information Report; and
- iii. To recommend mitigating measures in order to reduce/ minimize the risks/ hazards to a level which is as low as reasonably practicable;
- iv. Documentation and reporting.

The risk assessment results will be presented in terms of individual risk only in comparison against the risk criteria established by DOE, Environmental Impact Assessment Guidelines for Risk Assessment, December 2004, EG 1/04.

3.4.2 Reference to Permissible Risk Levels

Risk to which persons are exposed can be grouped into two distinct categories, i.e. voluntary and involuntary. Voluntary risk levels are those that persons are willing to be exposed to such risk levels or willing to take part in the activity that pose to such risk levels, knowingly the potential hazards associated with such

	ADDITIONAL INFORMATION TO THE DEIA REFINERY AND PETROCHEMICAL INTEGRATED DEVELOPMENT (RAPID) PROJECT, PENGERANG JOHOR, 2012 TO INCLUDE EURO 5 MOGAS AND OLEFIN TANK UNITS	
	CHAPTER 3 APPROACH AND METHODOLOGY	

activity. Precautionary steps would normally be taken so as to derive the benefits from taking part in such activity. Examples of voluntary exposure to risk are activities such as swimming, flying in commercial or private aircraft, driving or riding in an automobile and working in a major hazardous industrial facility.

Involuntary risk levels are those that persons take for granted that they would not be affected or harmed in their daily life. As such, the involuntary risk level would be very low and deemed insignificant. For example, a person staying in his/her own home in residential area would feel safe. The risk of fatality whilst staying in the house would be the background risk of death due to natural causes.

The recommended risk tolerability criteria for Malaysia are:

- i. The 1×10^{-6} fatalities/person per year individual risk contour should not encompass involuntary recipients of industrial risks such as residential areas, schools, hospitals and places of continuous occupancy, etc.
- ii. The 1×10^{-5} fatalities/person per year individual risk contour should not extend beyond industrial developments.

For the purpose of this study, the risk criteria proposed above has been adopted.



3.4.3 Study Approach and Methodology

The principal stages of this risk assessment are as follows:

3.4.3.1 Data Collection

Information is collected and documented covering the following areas:

- i. Process information: the layout of the proposed new processes and units that have changes in their licensed technology and the respective details of the engineering design (process flow diagrams and associated heat and material balances);
- ii. Surrounding environment: the topography, meteorology, population distribution, possible ignition sources within or surrounding the proposed project site; and

	ADDITIONAL INFORMATION TO THE DEIA REFINERY AND PETROCHEMICAL INTEGRATED DEVELOPMENT (RAPID) PROJECT, PENERANG JOHOR, 2012 TO INCLUDE EURO 5 MOGAS AND OLEFIN TANK UNITS	
	CHAPTER 3 APPROACH AND METHODOLOGY	

- iii. Safety measures: the measures available to prevent and/or mitigate possible accidents.

3.4.3.2 Hazard Identification



All potential hazards resulting from the failures of handling and storage of the hazardous substances are identified at this stage. The identification process shall be based on the process flow diagrams of each process and the associated heat and material balances. A representative set of discrete initiating events was short listed after a full review of the process and hazardous substances present onsite. The consequences of these scenarios were further evaluated and their risk was quantified in the study.

The QRA shall address failures of the following equipment:

- i. Pressure Vessels (all process vessel as per the process flow diagram, PFD) or based on potential main inventory hold up vessels (which will be provided by PETRONAS in absence of the process PFD and equipment data)
- ii. Intermediate Storage Tanks
- iii. Pumps
- iv. Heat Exchangers
- v. Major pipelines between plants and tank farms

3.4.3.3 Frequency Analysis

All event outcome frequencies will be calculated based on generic data of failure rates/ leak frequencies applicable for each relevant industry. This includes quantification of the frequency of initiating events and quantification of the frequency of various hazardous outcomes. The failure rate data which is to be used for this study is published by the UK Health and Safety Executive (UK HSE) - Offshore Hydrocarbon Release Data, HSE OSD, 2011.

	ADDITIONAL INFORMATION TO THE DEIA REFINERY AND PETROCHEMICAL INTEGRATED DEVELOPMENT (RAPID) PROJECT, PENERANG JOHOR, 2012 TO INCLUDE EURO 5 MOGAS AND OLEFIN TANK UNITS	
	CHAPTER 3 APPROACH AND METHODOLOGY	

3.4.3.4 Consequence Modelling



This stage of the QRA involves the determination of the impact of each of the identified hazardous outcomes on the surrounding population. The hazardous outcomes that will be evaluated in this study are Pool Fire, Jet Fire, Flash Fire and Explosion. The consequences of each event are determined by using Cascade Consequence Modelling Software. The consequences are expressed as distance to levels, which can cause fatalities.

3.4.3.5 Event Tree Analysis

Event tree analysis involves taking each initiating event through a defined sequence of events to determine the likelihood that an associated hazardous outcome will occur. Such event trees will take into account the necessary conditions for the hazardous outcome to occur, such as ignition. By assigning probabilities to each branch of the event tree, the final frequency of each outcome can then be established. The frequency of occurrence and probabilities of the initiating events develops to that outcome. The consequences associated with each of the hazardous outcomes can then be evaluated.

3.4.3.6 Risk Summation

After completion of consequence analysis and event tree analysis, the risk summation for all scenarios will be conducted. Risk summation involves combining the frequency of a given event outcome with its associated consequences to determine the individual risk levels associated with the facility. For the purpose of this study, risks evaluated are reported in terms of Individual Risk (IR). Individual risk may be defined as the frequency of fatality per individual per year due to the realisation of specified hazards. Cumulative impacts will be presented in terms of risk contours only for processes/ plants in the Refinery Plants complex and overall RAPID complex.

	ADDITIONAL INFORMATION TO THE DEIA REFINERY AND PETROCHEMICAL INTEGRATED DEVELOPMENT (RAPID) PROJECT, PENERANG JOHOR, 2012 TO INCLUDE EURO 5 MOGAS AND OLEFIN TANK UNITS	
	CHAPTER 3 APPROACH AND METHODOLOGY	

3.4.3.7 Major Risk Contributors

The risk generated by each accident scenario is ranked in terms of initiating source and consequence type (i.e. explosion, jet fire, pool fire, etc.). Consequence plots for all worst case scenarios and worst case credible scenarios for each process will be identified and discussed in this additional information report.



3.4.3.8 Risk Mitigation Measures

Based on the risk assessment results, risk mitigation measures will be identified, as required, to reduce the risks to levels that are As Low As Reasonably Practicable (ALARP), including engineering solutions, where applicable.

3.4.4 Modelling Scenarios

In the modelling, all worst case scenarios (i.e. scenarios which result in furthest consequence distances irrespective of the failure probabilities) and worst case credible scenarios (scenarios which result in furthest consequence distances and its event frequencies are greater or equivalent to 1×10^{-6} per year) will be addressed. The scenarios will be highlighted based on the isolatable section/ process section which may result in a worst case scenario or a worst case credible scenario for each process unit. The QRA shall not take into account scenarios that are a result of natural disasters, terrorist attacks and any causes which are beyond the control of the plant operators. This is further justified by failure rates which also do not take into account causes which are beyond the control of plant operators.

The worst case scenarios due the failure of a single equipment for fire events and toxic dispersion events in terms of IDLH distances will be identified and presented in contours for appreciation of the worst case scenarios. The entire risk for each operating unit will be presented in terms of individual risk contours.

 PETRONAS	ADDITIONAL INFORMATION TO THE DEIA REFINERY AND PETROCHEMICAL INTEGRATED DEVELOPMENT (RAPID) PROJECT, PENERANG JOHOR, 2012 TO INCLUDE EURO 5 MOGAS AND OLEFIN TANK UNITS	
	CHAPTER 3 APPROACH AND METHODOLOGY	

3.4.5 QRA Model

The consequences of each event are determined by using Cascade Consequence Modelling Software. The consequences are expressed as distance to levels, which can cause fatalities. Cascade can automatically join together the mathematical models which constitute a release scenario, from initial release to final dispersion or fire effect. The mathematical models are based typically on physical principles and empirical correlations found in literature references. The models in Cascade are based on an interpretation of physical models presented below:

- i. Gas release rates: General interpretation from Chemical Engineering texts including gas compressibility;
- ii. Liquid release rates: General interpretation from Chemical Engineering texts of the Bernoulli mechanical energy balance equation;
- iii. Flashing liquid release rates: The Fauske model;
- iv. Boiling/evaporation of liquids: The Shaw and Briscoe/ Matthiessen model;
- v. Momentum gas dispersion: The Ooms model;
- vi. Heavy gas dispersion: The Colenbrander model;
- vii. Jet fire model: The Chamberlain model;
- viii. Pool fire model: The Mudan model;
- ix. Fireball model: Combination TNO / Roberts model; and
- x. Explosion model: The TNO multi-energy model.

3.4.6 Consequence Modelling and Approach

The assumptions used for the consequence modelling are as follows:

- Material selected for consequence modelling is the material which is a dominant material in a mixture stream and must also be hazardous (flammable and toxic by inhalation).
- Surface Roughness used in dispersion modelling is 0.3 (for industrial area). This is because the whole RAPID development shall be within a designated industrial area.

- Probit Correlation is used to calculate the required toxic concentration. Center for Chemical Process Safety (CCPS). 1989a. *Guidelines for Chemical Process Quantitative Risk Analysis*. A.I.Ch.E., Center for Chemical Process Safety, New York.
- Toxic dispersion for vapour material has the same steps as Flash Fire for vapour material. However the concentration of interest has to be calculated from the probit equation for toxic gases:

$$Y = k_1 + k_2 \ln c^n$$

Where Y: probit value from graph
 k_1 , k_2 and n : probit constant, taken from table of probit equation parameters
 c : concentration in ppm
 Y value is normally taken at 3%, 50% and 100%, which corresponds to fatality rates.

Substance	Probit equation parameters ^a		
	CCPS ^b		
	k_1	k_2	n
Acrolein	-9.931	2.049	1
Acrylonitrile	-29.42	3.008	1.43
Ammonia ^d	-35.9	1.85	2
Benzene ^c	-109.78	5.3	2
Bromine ^c	-9.04	0.92	2
Carbon monoxide ^c	-37.98	3.7	1
Carbon tetrachloride	-6.29	0.408	2.5
Chlorine ^d	-8.29	0.92	2
Ethylene oxide ^c	-	-	-
Formaldehyde ^c	-12.24	1.3	2
Hydrogen chloride	-16.85	2.0	1.00
Hydrogen cyanide	-29.42	3.008	1.43
Hydrogen fluoride ^d	-35.87	3.354	1.00
Hydrogen sulphide	-31.42	3.008	1.43
Methyl bromide	-56.81	5.27	1.00
Methyl isocyanate ^c	-5.642	1.637	0.653
Nitrogen dioxide ^c	-13.79	1.4	2
Phosgene	-19.27	3.686	1
Propylene oxide	-7.415	0.509	2.00
Sulphur dioxide	-15.67	2.10	1.00
Toluene	-6.794	0.408	2.5

Due the limitation of chemicals within the Cascade consequence modelling software, for materials which are not available in the database, chemicals with similar Maximum Energy Value shall be selected as a representative material for consequence modelling purposes. BLEVE consequence modelling will be conducted based on the approach discussed below. Merv Fingas, 2001, *The Handbook of Hazardous Material Spills Technology*, McGraw-Hill.

Finding Conscience Distance of BLEVE

Real distance, d [m] is calculated as follow:

$$d = d_n (\beta \cdot W_{TNT})^{1/3}$$

	Scaled distance	d_n	[m.kg ^{-1/3}]
	Real distance	d	[m]
	Pressure wave energy release Fraction (constant)	$\beta = 0.5$	[]
	TNT Equivalent mass	W_{TNT}	[kg]

Real distance, d_n [m.kg^{-1/3}] is taken from the graph, pressure wave as a function of the scaled distance; at the pressure 1.18bar, 1.91bar, and 5.99bar:

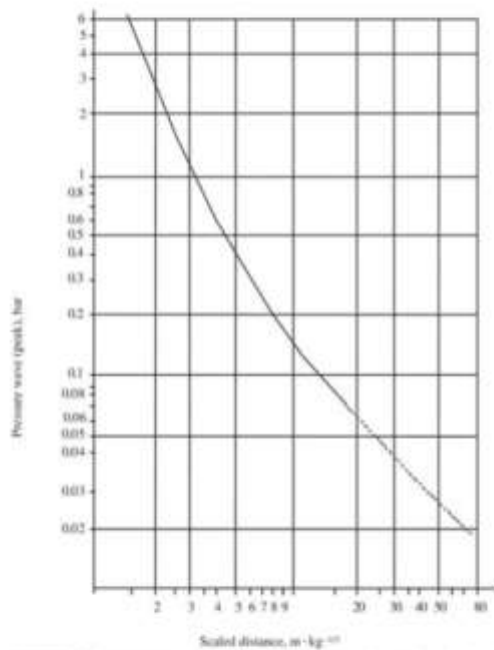


FIGURE 21.3 Pressure wave as a function of the scaled distance. (Source: Van den Berg and Lammey, 1993)

Whereas from the graph (* $d_n = Z$);

- 1.18bar with 1% fatality given $d_n = 3$ m/kg^{1/3}
- 1.91 bar with 50% fatality given $d_n = 2.4$ m/kg^{1/3}
- 5.99 bar with 99% fatality given $d_n = 1.5$ m/kg^{1/3}

TNT Equivalent mass W_{TNT} [kg] is calculated as follow:

$$W_{TNT} = \left(\frac{0.021 \cdot P \cdot V^*}{\gamma - 1} \right) \cdot \left(1 - \left(\frac{P_a}{P} \right)^{(\gamma-1)/\gamma} \right)$$

Equipment Design Pressure	P	[bara]
Material Specific heat ratio	γ	[]
Atmospheric pressure	P_a	[bara]
Total Volume (vapour + liquid)	V^*	[m ³]

Total Volume V^* [m^3] is calculated as follow:

$$V^* = V + V_l f \left(\frac{\rho_l}{\rho_v} \right)$$

Volume of vapour in vessel	V	[m^3]
Volume of Liquid in vessel	V_l	[m^3]
Liquid density @ T_o & P_o	ρ_l	[kg/m^3]
Vapor density @ T_o & P_o	ρ_v	[kg/m^3]
Vaporization fraction	f	[]

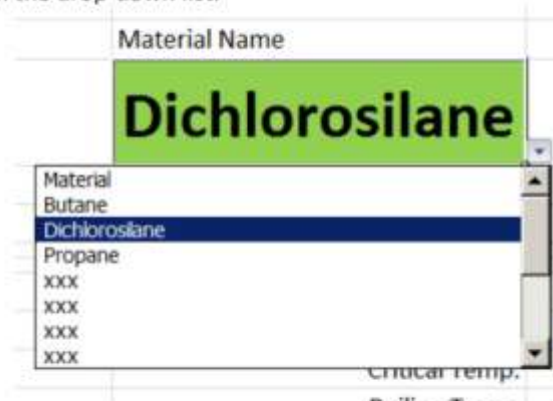
Vaporization fraction, f is calculated as follow:

$$f = 1 - \exp(-2.63(C_p/H_v)(T_c - T_b) \cdot (1 - ((T_c - T_o)/(T_c - T_b))^{0.38}))$$

Material Specific Heat	C_p	[$J/kg.K$]
Material Enthalpy of vaporization	H_v	[J/kg]
Material Critical Temp.	T_c	[K]
Material Boiling Temp.	T_b	[K]
Equipment Design Temp.	T_o	[K]

Finding Conscience Distance of BLEVE using Excel Spreadsheet

1. Open the spreadsheet file named 'XXXXXX BLEVE CALCULATION.xlsx'
2. Select material from the drop-down list:



3. GREEN boxes are for user to input the value. Never change the value in the RED and GREY boxes:



4. Fill in below boxes with the given data:

a. Design temperature in Kelvin:

Design Temp. **To** [K]

b. Volume of vapour & liquid in the vessel in cubic meter:

Volume of vapor in vessel **V** [m3]

Volume of Liquid in vessel **Vi** [m3]

c. Vapour density at the given Temperature and Pressure in kg/m³:

Vapor density @To&Po **ρ_v** [kg/m3]

Design Pressure **P** [bara]



5. Take the 1%, 50%, and 99% fatality rate value in the red box, and record it in the consequence modelling spreadsheet:

		Fatality rate		
		1%	50%	99%
Real distance	d	192.85	2.31	1.45

3.4.7 Data Gathering

In order to establish to establish the hazardous outcome scenarios for the additional new Refinery processes and units that have changes in their licensed technology under the scope of this Additional Information Report, the process information such as Process Flow Diagrams, Process and Instrumentation Drawings and Heat & Material Balances will be reviewed to determine the events which will be evaluated. Should the PFD and its associated heat and material balance document is not available PETRONAS shall provide a list of major vessels which shall be considered for consequence modelling purposes for the affected process or plants. This shall then form the potential leak scenario sources for the particular plant. The dimension, operating conditions (pressure and temperature) and name of the major hazardous substance being held as inventory for all the listed major vessels shall also be provided.

Location of the major vessels within each plot plant shall be provided. In the absence of such data, consequence and risk plots for that particular process/unit shall be plotted from the centre of the unit's proposed plot.

	ADDITIONAL INFORMATION TO THE DEIA REFINERY AND PETROCHEMICAL INTEGRATED DEVELOPMENT (RAPID) PROJECT, PENERANG JOHOR, 2012 TO INCLUDE EURO 5 MOGAS AND OLEFIN TANK UNITS	
	CHAPTER 3 APPROACH AND METHODOLOGY	

3.5 EFFLUENT DISPERSION MODELLING

An effluent dispersion modelling of the proposed treated effluent discharged from Centralised Effluent Treatment Plant (ETP) via an ETP outfall to the sea will be carried out following Jabatan Pengairan dan Saliran Malaysia (JPS) guidelines. No JPS approval is needed as cumulative study is to be done under separate EIA studies for the marine structures within RAPID site. The coastal hydraulic study for JPS approval shall be obtained under the EIA submission for the RAPID Solid Product Jetty (SPJ). In this Additional Information Report, reference is to be made to that study and result of the dispersion modelling for the ETP outfall shall be referred to the studies conducted under the SPJ EIA.

3.5.1 Scope of Study



Assessment on the effluent dispersion characteristic will be focus on the release from the proposed ETP with emphasis on the following impacts:

- Water quality changes due to discharge of industrial and domestic effluents;
- Temperature and salinity changes due to the fresh water discharge from the treatment plant;

It should be noted that this study will not focus on the assessment of other RAPID coastal structures such as Storm Water Outlet (SWO), Solid Product Jetty (SPJ) and Material Offloading Facility (MOLF) as this will be addressed in separate hydraulic study.

3.5.2 Applicable Regulatory Framework

Reference on the permissible water quality will be based on the Malaysian Marine Water Quality Criteria and Standard (MMWQS) published by the Department of Environment Malaysia.

	ADDITIONAL INFORMATION TO THE DEIA REFINERY AND PETROCHEMICAL INTEGRATED DEVELOPMENT (RAPID) PROJECT, PENERANG JOHOR, 2012 TO INCLUDE EURO 5 MOGAS AND OLEFIN TANK UNITS	
	CHAPTER 3 APPROACH AND METHODOLOGY	

3.5.3 Study Approach and Methodology

The following tasks were carried out for the effluent dispersal assessment:

- Gathering of available data from previous studies of the area;
- Modelling and implementation of calibrated 3D hydrodynamic model to describe the effluent dispersal and water exchange at the site;
- Analysis and presentation of results.

3.5.3.1 Data Gathering

The relevant information, such as bathymetric survey data and project documents have been collected in order to aid the understanding of the existing physical hydraulic condition and the description of proposed development.

3.5.3.1.1 Bathymetric Survey Data

DHI has undertaken hydraulic studies in the area and possesses calibrated models that are readily available for the effluent dispersion assessment. These models have been updated with the following bathymetric survey data from previous studies that carried out at the Pengerang area.

Table 3.3: Details of Bathymetric Survey

No.	Survey Campaign	Date of Survey
1	Pengerang Deep-water Terminal DEIA	December 2009
2	RAPID DEIA	April 2012
3	Solid Product Jetty FEED	June 2015

3.5.3.1.2 Water Quality Sampling

Water quality samples for baseline conditions were taken in November 2011 and December 2012. However due to the on-going development that has been taken place close to the project area, RAPID Monitoring June 2016 data

for marine water quality is being used to reflect the current condition. Followings are few of the tested parameters used in this study:

- Nitrate as NO₃
- Phosphate as P
- Total Suspended Solids (TSS)
- Oil and Grease
- Total Nitrogen
- Ammonia
- Phenol

These parameters were compared with the Class 3 of Malaysia Marine Water Quality Standards of 29th November 2010 (MMWQS) in order to have an overview of water quality near the project area. The definition of the MMWQS classes are as follows:



Table 3.4: MMWQS Classification

MMWQS Class	Beneficial uses
Class 1	Preservation, Marine Protected areas, Marine Parks
Class 2	Marine life, Fisheries, Coral Reefs, Recreational and Marine culture
Class 3	Ports, Oil & Gas Fields
Class E	Mangroves Estuarine & River mouth Water

3.5.3.1.3 Reference Document

Information from the following documents has been used as reference on the proposed outfall and assessment:

- Hydraulic & Coastal Modelling Report. Detailed Environment Impact Assessment (DEIA) for the proposed Refinery and Petrochemical Integrated Development (RAPID) project at Tg. Setapa, Johor
- Malaysia Marine Water Quality and Standard (MMWQS) of 29th November 2010

	ADDITIONAL INFORMATION TO THE DEIA REFINERY AND PETROCHEMICAL INTEGRATED DEVELOPMENT (RAPID) PROJECT, PENERANG JOHOR, 2012 TO INCLUDE EURO 5 MOGAS AND OLEFIN TANK UNITS	
	CHAPTER 3 APPROACH AND METHODOLOGY	

- Standard B of Environmental Quality Regulation 2009 for Sewage and Industrial Effluent (Malaysian Standard B)
- RAPID-P016A-VWM-PRO-DES-6300-0001_1 (Design Basis - Unit 6300 Common Facilities)
- RAPID-P016A-VWM-PRO-CAL-6300-0001_0A (Calculation Reports & Notes - Unit 6300 ETP Common Facilities)
- RAPID-FE1-TPX-HSE-DES-0001-0006_3_S (Job Specification for Design – Environmental & Health Design Basis)

3.5.3.2 Establishment of Numerical Models



Numerical modelling has been applied in this study to support the assessments of potential dispersion impacts induced by effluents released from the proposed marine outfall. The dilution of effluent release in open waters occurs due to the mixing process mainly influenced by the ambient current flow conditions. The effluent plume will potentially be diluted and travel further away from the release point during stronger current flow conditions.

Therefore the dispersion of effluent has been modelled using MIKE 3 by DHI (3-dimensional model) to simulate the flow conditions and water levels variations in the study area. This 3D model is useful in describing the vertical flows of density differences in salinity. The release of fresh water from the outfall may produce an upward mixing process from the bottom towards the surface.

3.5.3.2.1 Model Complex

A number of different models have been developed to assess the effluent dispersion conditions:

- MIKE 3 Hydrodynamic (HD) Model

	ADDITIONAL INFORMATION TO THE DEIA REFINERY AND PETROCHEMICAL INTEGRATED DEVELOPMENT (RAPID) PROJECT, PENGERANG JOHOR, 2012 TO INCLUDE EURO 5 MOGAS AND OLEFIN TANK UNITS	
	CHAPTER 3 APPROACH AND METHODOLOGY	

- The MIKE 3 HD module has been used for modelling of current flows, water levels and salinity variations. The HD module simulates water level variations and flows in response to a variety of forcing functions in oceans, lakes, estuaries, bay and coastal regions. It is applied to a wide range of hydraulics related phenomena including tidal hydraulics, wind and wave generated currents, storm surges and flood waves.
 - The MIKE 3 HD module is the base computational hydrodynamics module of the entire MIKE 3 system providing the hydrodynamics basis for MIKE 3 Advection-Dispersion that will be described below.
- **MIKE 3 Advection-Dispersion (AD) Model**
 - The dispersion of pollutant has been modelled using MIKE 3 AD model coupling with HD module.
 - The advection-dispersion module simulates the spreading of a dissolved or suspended substance in an aquatic environment under the influence of the fluid transport and associated natural dispersion process. In the present study, the substance are a list of pollutants as taken from ETP design and discharge loading information (i.e: concentration limit), which is released from the proposed marine outfall and treated as conservative effluent without no decaying.
 - This provides conservative input to the environment impact assessment.

3.5.3.2.2 Model Domain

The model applied in this study is based on an unstructured mesh; an approach where the bathymetry resolution can be varied depending on modelling requirements. This is a fundamental flexibility of the model that allows the spatial resolution to be increased towards sensitive areas including the nearshore areas and the area of the proposed outfall while maintaining low resolution in open areas, where the scale of processes tends to be larger. The use of unstructured meshes also provides additional flexibility in the vertical discretization. The sigma layer system attributes a relative percentage of the actual water depth to a user defined number of layers (sum of the layer

must equal to one). This means that the actual layer thickness has been used to resolve the water depth in the model domain. In deeper waters, the element sizes are typically coarser, while in shallower waters (typically near the coastline and in the immediate area of interest) the resolution is higher. This approach has proven to be useful for the present study as the study area is characterised by its complex coastal developments and morphology. These bathymetrical complexities influence the hydraulic processes and the transformation of current and waves from offshore to near-shore waters. The varying spatial elements enable the model to represent both offshore and detailed nearshore conditions accurately in the same model, whilst maintaining a reasonable computational efficiency. A model mesh was established from the bathymetric information obtained from digital admiralty charts and from bathymetric data collected on the site. An overview of the model domain is presented in **Figure 3-2**.

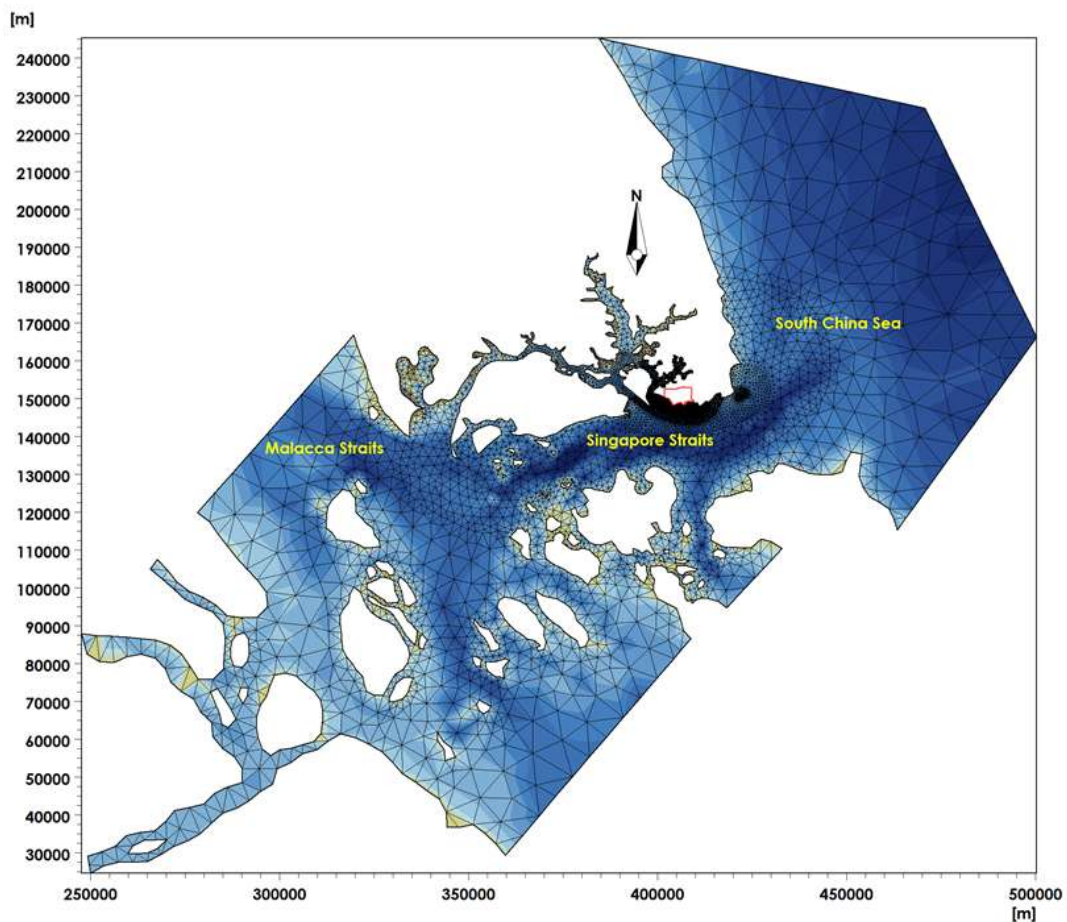


Figure 3-2: Overview of the model mesh applied for the effluent dispersion assessment. Location of the study area is outlined in red.

3.5.3.2.3 Model Setting

The effluent dispersion model was set up based on treated effluent from the ETP observation pond released and dispersed via the effluent treatment plant buried marine outfall.

The area close to the outfall has been updated with bathymetry data in year 2015 (refer to **Table 3.3**) shared from other recent studies.

Overview of the simulated layout is shown in **Figure 3-3**.

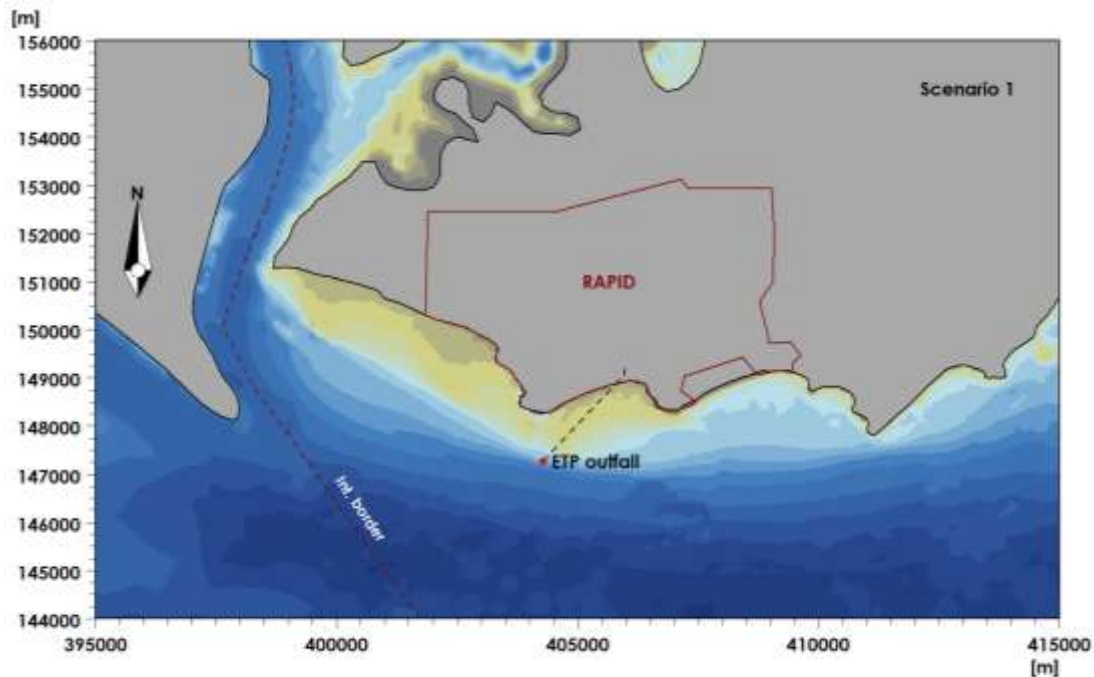




Figure 3-3: Modelled layout.

Since impacts may differ depending on the seasonal conditions, it is, therefore, important to establish realistic seasonal conditions for the quantification of impacts. Three (3) seasonal conditions have been defined to assess the potential dispersion assessment.

- **Northeast Monsoon conditions (NE)** that represent flows during Northeast Monsoon periods when winds and tidal currents interact.

 PETRONAS	ADDITIONAL INFORMATION TO THE DEIA REFINERY AND PETROCHEMICAL INTEGRATED DEVELOPMENT (RAPID) PROJECT, PENERANG JOHOR, 2012 TO INCLUDE EURO 5 MOGAS AND OLEFIN TANK UNITS	
	CHAPTER 3 APPROACH AND METHODOLOGY	

The wind from the N-NE is predominant during this monsoon season. The wind with the magnitude of 5 m/s coming from 20 degree has been used.



- **Southwest Monsoon conditions (SW)** that represent flows during Southwest Monsoon periods when tidal currents interact with predominant winds from S-SE. For this, wind with the magnitude of 5 m/s coming from 180 degree was used.
- **Inter-Monsoon conditions (IM):** Represents conditions during Inter-Monsoon events when winds are not significant therefore flows are mainly tidal driven. This scenario is also referred as pure tides.

The seasonal conditions, which include tidal conditions and seasonal weather patterns in the region, are represented in 17 days (3+14) simulation periods for simulation of both neap and spring tidal cycles. This includes 3 days of warm up to avoid any type of numerical instabilities that could occur during the initial stage of the simulations.

3.6 Assessment Approach

Assessment of the effluent dispersal will be focused on the released effluent from the proposed outfall with emphasis on the following key elements:

- Changes in Ambient Salinity
 - Salinity changes due to the discharge of combined effluent and fresh water from the outfall.
- Effluent Dispersion
 - Dispersion of effluent and capacity of water exchange in the project area. Good water exchange allows effluents to be dispersed in the marine quickly and efficiently

	ADDITIONAL INFORMATION TO THE DEIA REFINERY AND PETROCHEMICAL INTEGRATED DEVELOPMENT (RAPID) PROJECT, PENGERANG JOHOR, 2012 TO INCLUDE EURO 5 MOGAS AND OLEFIN TANK UNITS	
	CHAPTER 3 APPROACH AND METHODOLOGY	

3.7 WASTE HANDLING AND MANAGEMENT STUDY

This waste handling and management study is to describe the generation, handling, storage and disposal of solid, scheduled waste, air emission and effluent specifically for the new units in Refinery Plants. The potential environmental impacts will be assessed and relevant and appropriate mitigation measures will be proposed where applicable.

3.7.1 Scope of Study



The Waste Handling and Management Study will cover the generation, handling, storage and disposal of waste generated throughout the operation phase. This will include:

- Industrial process waste from routine operations and maintenance, turnaround waste.
- Associated municipal wastes such as office wastes, food scraps and plastics.

3.7.2 Applicable Regulatory Framework

The development of the waste handling and management study will be guided by the relevant legislative requirements and guidelines. A list of key legislation and guidelines are provided below:

- i. Environmental Quality Act 1974 – Act 127
- ii. Solid Waste and Public Cleansing Management Act 2007
- iii. Environmental Quality (Scheduled Waste) Regulations, 2005 (Amendment 2007)
- iv. Environmental Quality (Prescribed Premises) (Scheduled Waste Treatment and Disposal Facilities) Regulations, 1989 (Amendment 2006)
- v. Environmental Quality (Prescribed Conveyance) (Scheduled Waste) Order, 2005

	ADDITIONAL INFORMATION TO THE DEIA REFINERY AND PETROCHEMICAL INTEGRATED DEVELOPMENT (RAPID) PROJECT, PENGERANG JOHOR, 2012 TO INCLUDE EURO 5 MOGAS AND OLEFIN TANK UNITS	
	CHAPTER 3 APPROACH AND METHODOLOGY	

- vi. Guidelines for Packaging, Labelling and Storage of Scheduled Wastes in Malaysia 2014

3.7.3 Study Approach and Methodology

The Waste Management Study will be conducted based on the following approach:

3.7.3.1 Development of Waste Inventory

An inventory will be developed for the new facilities, and wastes will be characterized and quantified to the extent possible given available information to date. The inventory shall include:



- i. Waste source
- ii. Waste type (scheduled/ non-scheduled)
- iii. Waste phase (liquid/ solid)
- iv. Waste mass/ volume (expected annual production)
- v. Proposed storage, treatment and disposal approach

3.7.3.2 Qualitative Waste Hazard Assessment

A qualitative waste hazard assessment will be conducted and will focus primarily on scheduled waste. The qualitative waste hazard assessment will consider the potential environmental risks and impacts associated with the generation, transport, storage, handling and treatment/disposal of wastes (solid and scheduled wastes) as well as the potential impact to sensitive receptors, including impacts due to accidental spills.

3.7.3.3 Waste Management Process Review

Once the waste inventory and assessment is complete, a waste management process review will be conducted to establish:

	ADDITIONAL INFORMATION TO THE DEIA REFINERY AND PETROCHEMICAL INTEGRATED DEVELOPMENT (RAPID) PROJECT, PENGERANG JOHOR, 2012 TO INCLUDE EURO 5 MOGAS AND OLEFIN TANK UNITS	
	CHAPTER 3 APPROACH AND METHODOLOGY	

- i. Appropriate segregation, handling, storage and transport protocols in accordance with Malaysian regulations and general good industry practice.
- ii. Requirements for waste management storage areas and treatment and disposal.
- iii. Recommendations will be provided for improved management using the Reduce, Reuse and Recycle (3R) approach.

3.7.3.4 Chemical Handling and Management



All chemicals will be characterized via review of Material Safety Data Sheets (MSDS) and quantified to the extent possible given available information. The review of MSDS's will also serve to identify the toxicity effect of these chemicals to the aquatic environment.

Upon completion of the chemical inventory and characterization, a chemical management process review will be conducted to establish:

- i. Appropriate segregation, handling, storage and transport protocols in accordance with Malaysian regulations and general good industry practice throughout the various project phases;
- ii. Requirements for chemical storage, transfer and handling areas;
- iii. Requirements for chemical segregation according to hazard classification as well as management of chemical related spills; and
- iv. The required drainage network to cater for the chemical spillage within the process area of the Refinery plants.

3.7.3.5 Study Outcome

Based on the outcomes of the study, appropriate mitigation and control measures will be proposed to minimize the impacts from activities related to chemical and waste management. A cumulative impact assessment for this study will be conducted for all the Refinery Plants units within the RAPID Refinery Plants area.

	ADDITIONAL INFORMATION TO THE DEIA REFINERY AND PETROCHEMICAL INTEGRATED DEVELOPMENT (RAPID) PROJECT, PENERANG JOHOR, 2012 TO INCLUDE EURO 5 MOGAS AND OLEFIN TANK UNITS	
	CHAPTER 3 APPROACH AND METHODOLOGY	

3.8 HEALTH IMPACT ASSESSMENT (HIA)

The health impact assessment (HIA) study will focus on the existing disease burden of the sensitive communities and on any potential impacts from the new units for EURO 5 MOGAS production and additional olefins storage.

The sensitive receptors are those people staying or institution located within the zone of impact (ZOI) of 5km radius from RAPID project boundaries. The current disease pattern among community members is very important as a baseline to ensure the health of present and future generations is secured and protected. Qualitative assessment is on the readiness of existing health facilities near the project site for a disaster management.

It's a process of estimating the potential impact of hazardous agents in a specified human population system under a specific set of conditions and for a certain time frame that may arise from the particular proposed project. The HIA study will cover all phases of the development like construction, operation and abandonment phases.



3.8.1 Scope of Study

The scope of this HIA shall include:

- i. The assessment of the disease burden of the affected communities residing nearby to the proposed project site.
- ii. The estimation of the cumulative health risk status of the affected communities that based on the air dispersion, effluent dispersion and noise modelling exercises, if any.

3.8.2 Applicable Regulatory Framework

In assessing the potential health impacts of the project, reference will be made to the following standards and guidelines.

	ADDITIONAL INFORMATION TO THE DEIA REFINERY AND PETROCHEMICAL INTEGRATED DEVELOPMENT (RAPID) PROJECT, PENERANG JOHOR, 2012 TO INCLUDE EURO 5 MOGAS AND OLEFIN TANK UNITS	
	CHAPTER 3 APPROACH AND METHODOLOGY	

- i. Guidance Document on Health Impact Assessment (HIA) in Environmental Impact Assessment (EIA) 2012.
- ii. Malaysian Ambient Air Quality Guidelines (2015).
- iii. Risk Assessment Guidance for Superfund, Volume I: Human Health Evaluation Manual (Part F, Supplemental Guidance for Inhalation Risk Assessment) USEPA 2009).
- iv. Recommended Industrial and Residential Noise level (DOE 2004)

3.8.3 Study Approach and Methodology



The HIA methodology will be based on the HIA Guidance Document on HIA in EIA (DOE, 2012). In the first part, it will involve the gathering of the secondary quantitative data from the District Health Office of Kota Tinggi, Johor. It will cover the existing public health status of the affected communities. The second part will be consisting of the estimation of health risk based on the modelling results. No primary data will be collected in this HIA.

3.8.3.1 Existing Public Health Status

This will involve describing the present health status of the population residing nearby to the project's site. It will involve the secondary data on disease morbidity, particularly on communicable and non-communicable diseases that will be requested from the District Health Office of Kota Tinggi. These tasks had already been completed in the approved Overall RAPID DEIA, 2012 submitted to the DOE. However, this report will add more data up to 2015.

3.8.3.2 Health Impact Assessment

The assessment will employ the approach adopted in the Guidance Document which comprises six basic steps, namely screening, scoping, hazard identification, dose-response assessment, exposure assessment, and risk characterization. For characterization of health risk, both non-carcinogenic and carcinogenic risk will be assessed as a hazard index (HI) and lifetime cancer

 PETRONAS	ADDITIONAL INFORMATION TO THE DEIA REFINERY AND PETROCHEMICAL INTEGRATED DEVELOPMENT (RAPID) PROJECT, PENERANG JOHOR, 2012 TO INCLUDE EURO 5 MOGAS AND OLEFIN TANK UNITS	
	CHAPTER 3 APPROACH AND METHODOLOGY	

risk (LCR). The cumulative HI should not more than one and LCR should not more than 10^4 per population.

The pollutants assessed were particulates and gaseous emission parameters from the identified sources as adopted in the Air Emission Dispersion Study:



The air pollutants that will be assessed for their health effects will be:

- i. Fine particulate ($PM_{2.5}$)
- ii. Respirable particulate (PM_{10})
- iii. Nitrogen dioxide (NO_2)
- iv. Sulphur dioxide (SO_2)
- v. Carbon monoxide (CO)
- vi. Ammonia (NH_3)
- vii. Methanol
- viii. Hydrogen sulphide (H_2S)

For non-methane volatile organic compounds (NMVOCs), it was not being assessed since there is no standard or guideline on its health effects. Similarly for unburned hydrocarbon (UH) that normally contain hydrogen and carbon, which collectively un-hazardous to human being.

For the ambient air health risk exposure, three scenarios have been considered during the assessment based on air dispersion modelling that include:

- i. Normal operation scenario with cumulative emissions from Refinery Complex and other RAPID components in normal operation mode,
- ii. Abnormal operation scenario with unmitigated emissions from selected sources in the Refinery Complex including Olefin Storage Tanks with cumulative emissions from other RAPID components in normal operation mode, and

	ADDITIONAL INFORMATION TO THE DEIA REFINERY AND PETROCHEMICAL INTEGRATED DEVELOPMENT (RAPID) PROJECT, Pengerang Johor, 2012 TO INCLUDE EURO 5 MOGAS AND OLEFIN TANK UNITS	
	CHAPTER 3 APPROACH AND METHODOLOGY	

- iii. Emergency operation scenario with unmitigated emissions from selected sources in the Refinery Complex with cumulative emissions from other RAPID components in normal operation mode.

3.9 Summary of Methodology and Approach

The methodology and approach for all process related specialized study is summarized in the following table:

Table 3.5: Methodology and Approach for the Six (6) Process Related Specialised Studies

Study Area	Study Approach	Modelling Software	Modelling Scenario	Study Boundary	Study Assumptions
Air Dispersion Modelling	As in previous DEIA, air emission and dispersion study will be conducted in accordance with USEPA Guideline on Air Quality Models which adopts AERMOD as the preferred dispersion model.	Latest USEPA's AERMOD model Version 15181, July 2015 (Lakes Environmental Inc. AERMOD View Version 9.1.0) and three years (2012-2014) of hourly meteorological data.	Normal and abnormal scenario for the followings: <ul style="list-style-type: none"> • Individual Emissions from each new refinery process unit. • Cumulative emissions from RAPID Refinery and Steam Cracker Complex (SCC) • Cumulative emissions from RAPID Complex which include emission sources from PCP, utilities and Petrochemical Complex. • Abnormal scenario is based only one failure event at a time, or based on the worst-case pollutant load 	Similar to previously approved RAPID DEIA, 2012, the study boundary will cover <ul style="list-style-type: none"> • RAPID project boundary. • 5 km radius from RAPID project boundary and with sensitive receptors. 	Emissions and source parameters will be based on RAPID Refinery Plants detail design and FEED design for EURO 5 MOGAS Units & Additional Olefins Storage Tanks.



CHAPTER 3
APPROACH AND METHODOLOGY

Study Area	Study Approach	Modelling Software	Modelling Scenario	Study Boundary	Study Assumptions
			<p>released from a selected failure event.</p> <ul style="list-style-type: none"> Emergency is based on full flare load based on one failure event at a time but dispersion is based on the worst/highest flare load. 		
Noise Dissipation Study	<ul style="list-style-type: none"> Noise models for individual new units Noise models for Cumulative RAPID Refinery & Cracker Complex (RCC). Noise model for Cumulative RAPID Complex which include emission sources from PCP, utilities and Petrochemical Complex. Noise sources from all major equipment and process of the respective process unit shall be represented. Environmental noise modelling shall be undertaken in accordance to ISO 9613-Part 2: 1996. Assessment will be carried out in accordance to DOE Noise Guidelines, PTS 31.10.00.31 and BS 4142: 	Noise modelling using Cadna-A Industrial Noise Modelling Software Version 3.7.123 from Datakustik.	<ul style="list-style-type: none"> Scenarios for “Normal” operations that will be modelled as follows: <ul style="list-style-type: none"> - Individual process unit - Combined process units operating simultaneously - Combined process units above repeated with a worst case prevailing wind condition. “Abnormal” conditions for the combined process unit scenario with flaring (emergency requiring utilization of the flare stack). 	<ul style="list-style-type: none"> Noise level assessment will be conducted at property boundary and at other locations of interest based on absolute numerical limits. Relative limits based on noise difference with the existing environment. Noise impact severity based on the noise increase above ambient. Noise maps shall be generated from the property boundaries to 5km radius of surrounding area, covering the sensitive receptors. 	<ul style="list-style-type: none"> Noise sources for equipment shall be modelled as point sources considering enclosures. Pipes and valves are assumed not to have acoustic induced vibration. Structure assumed transparent. Buildings and storage tanks with shielding. Assume continuous plant operations. Vibration and low frequency sound are not included.



CHAPTER 3
APPROACH AND METHODOLOGY

Study Area	Study Approach	Modelling Software	Modelling Scenario	Study Boundary	Study Assumptions
	1997.				
Quantitative Risk Assessment (QRA)	<ul style="list-style-type: none"> Standard approach in accordance to the DOE EIA Guidelines for Risk Assessment 2004. The potential impacts that will be assessed are in terms of fire, explosion and toxic dispersion events due to accidental releases of hazardous substances from the proposed Refinery plants. The QRA shall address failures of the Pressure Vessels (all process vessel as per the process flow diagram, PFD); major pipelines, intermediate storage tanks; pumps; and heat exchangers. Should the PFD and its associated heat and material balance document is not available PETRONAS shall provide a list of major vessels which shall be considered for consequence modelling purposes for the affected process or plants. This shall then 	Consequence Modelling will be conducted via the Cascade Consequence Modelling Software	<ul style="list-style-type: none"> All worst case scenarios (i.e. scenarios which result in furthest consequence distances irrespective of the failure probabilities) and worst case credible scenarios (scenarios which result in furthest consequence distances and its event frequencies are greater or equivalent to 1×10^{-6} per year) will be addressed. The scenarios will be highlighted based on the isolatable section/ process section which may result in a worst case scenario or a worst case credible scenario for each process unit. The worst case scenarios due the failure of a single equipment for fire events and toxic dispersion events in terms of IDLH 	<ul style="list-style-type: none"> Risk contour will be presented in terms of Individual Risk (IR) for all worst case scenarios and worst case credible scenarios, presenting the furthest consequence distances, in relation to the property boundaries and sensitive receptors. 	<ul style="list-style-type: none"> Cumulative impacts will be presented in terms of risk contours for processes/ plants within the Refinery and Cracker Complex and overall RAPID complex.



CHAPTER 3
APPROACH AND METHODOLOGY

Study Area	Study Approach	Modelling Software	Modelling Scenario	Study Boundary	Study Assumptions
	<p>form the potential leak scenario sources for the particular plant. The dimension, operating conditions (pressure and temperature) and name of the major hazardous substance being held as inventory for all the listed major vessels shall also be provided.</p> <ul style="list-style-type: none"> • Location of the major vessels within each plot plant shall be provided. In the absence of such data, consequence and risk plots for that particular process/unit shall be plotted from the centre of the unit's proposed plot. • The failure rate data which is to be used for this study is published by the US Health and Safety Executive (UK HSE) - Offshore Hydrocarbon Release Data, HSE OSD, 2011. • Risk mitigation measures will be identified, as required, to reduce the risks to levels that are As Low As Reasonably Practicable (ALARP), 		<p>distances will be identified and presented in contours for appreciation of the worst case scenarios. The entire risk for each operating unit will be presented in terms of individual risk contours.</p>		



CHAPTER 3
APPROACH AND METHODOLOGY

Study Area	Study Approach	Modelling Software	Modelling Scenario	Study Boundary	Study Assumptions
	including engineering solutions, where applicable.				
Effluent Dispersion Modelling	<ul style="list-style-type: none"> Modelling works will be carried out according to JPS guidelines. Hydraulic studies have been undertaken in the area and calibrated models are readily available for the Additional Information Report. These models will be updated with recent (less than 2 years old) available data from previous studies of the area to verify existing numerical models and ensure that JPS requirements are met. Assessment of the effluent dispersal will be focused on the released effluent from the proposed outfall with emphasis on the following key elements: <ol style="list-style-type: none"> Changes in Ambient Salinity Salinity changes due to the discharge of combined effluent and fresh water from the outfall. 	<ul style="list-style-type: none"> MIKE 3 model will be applied to simulate dispersal of the pollutants from the proposed marine outfall. 	<ul style="list-style-type: none"> Three climatic conditions will be defined to assess the potential hydraulic impacts: <ul style="list-style-type: none"> Northeast Monsoon conditions (NE) Southwest Monsoon conditions (SW) Inter-monsoon conditions (PT) Simulation period above include 3 days of warm-up (to avoid any type of instabilities or inaccuracies that could occur during the initial state of the simulations. 	<ul style="list-style-type: none"> The study does not include the dispersion of chemicals accidentally spilled to the aquatic environment (not discharged through the outlet) and changes to surface run-off from the development area. 	<ul style="list-style-type: none"> Assumed no submission to JPS is required for this study; currently the marine cumulative hydraulic study is being undertaken by another package in RAPID i.e. the Solid Product Jetty since this package is required to prepare its own EIA for approval by Johor DOE. Under this package, the cumulative hydraulic study required by JPS and DOE for the EIA submission includes RAPID marine structure such as Solid product jetty, Effluent treatment plant outfall, Storm water outfall and



CHAPTER 3
APPROACH AND METHODOLOGY

Study Area	Study Approach	Modelling Software	Modelling Scenario	Study Boundary	Study Assumptions
	ii. Effluent Dispersion Dispersion of effluent and capacity of water exchange in the project area. Good water exchange allows effluents to be dispersed in the marine quickly and efficiently				Material Offloading facility (MOLF) at Tj Setapa. <ul style="list-style-type: none"> The development does not involve any land reclamations or dredging. There are no coastal protection works required at the site and there will be no coastal structures that adversely affect the littoral sediment transport. Cooling water systems for operation of the refinery are integrated with a single line intake and outlet. Effluents from the refinery production will be discharged through a single outlet.
Waste Handling and Management	<ul style="list-style-type: none"> The Waste Management Study will be conducted based on the following approach: 	<ul style="list-style-type: none"> No modelling software will be 	-	<ul style="list-style-type: none"> The study will cover the generation, handling, storage and disposal of 	<ul style="list-style-type: none"> Study will be based on information provided by



ADDITIONAL INFORMATION TO THE DEIA REFINERY AND PETROCHEMICAL INTEGRATED DEVELOPMENT (RAPID) PROJECT, PENGERANG JOHOR, 2012 TO INCLUDE EURO 5 MOGAS AND OLEFIN TANK UNITS





**CHAPTER 3
APPROACH AND METHODOLOGY**

Study Area	Study Approach	Modelling Software	Modelling Scenario	Study Boundary	Study Assumptions
	<ul style="list-style-type: none"> Development of waste inventory. Qualitative waste hazard assessment Waste management process review Chemical handling and management Relevant and appropriate mitigation and control measures will be proposed to minimise impacts from activities related to chemical and waste management. 	used.		waste generated throughout the operation phase <ul style="list-style-type: none"> This include industrial process waste from routine operations and maintenance, turnaround waste, and associated municipal wastes such as office wastes, food scraps and plastics. 	PETRONAS.
Health Impact Assessment (HIA)	<ul style="list-style-type: none"> The HIA methodology will be based on the HIA Guidance Document on HIA in EIA (DOE, 2012). Qualitative assessment will be performed on the existing health facilities within the District of Kota Tinggi accessible to the receptors around RAPID site. Quantitative assessment will be performed based on the morbidity data from the District Health Office of Kota Tinggi, and from 	<ul style="list-style-type: none"> No modelling software will be used. 	<ul style="list-style-type: none"> Evaluation Scenario in accordance with the scenarios modelled in the air, and effluent dispersion studies and noise modelling. 	<ul style="list-style-type: none"> The zone of impact of 5km from the boundary of the RAPID site is applicable for general assessment of the general public health conditions of the receptors. For qualitative assessment of the existing public health facilities, the study boundary will be extended to cover the nearby health facilities 	<ul style="list-style-type: none"> No primary data will be collected from the field. No quantitative HRA will be performed for the receptors of air emission exposure at the international boundary between Singapore and Malaysia because the outcome of the Air Dispersion Modelling was



CHAPTER 3
APPROACH AND METHODOLOGY

	<p>maximum Ground Level Concentrations (GLCs) derived from the Air Dispersion Modelling.</p> <ul style="list-style-type: none">• Estimation of health impacts based on the effluent dispersion and noise modelling.			<p>like Hospital Kota Tinggi, Klinik Kesihatan Pengerang and Klinik Kesihatan Sungai Rengit.</p> <ul style="list-style-type: none">• For health risk assessment, the study boundary will be extended to cover the extent of the impact as determined by the outcome of the Air Dispersion Modelling.	<p>intended to ensure compliance against the Singapore Ambient Air Quality Targets (in particular for PM2.5) only.</p> <ul style="list-style-type: none">• For VOC risk characterization, only selected chemical compounds which are either highly toxic (e.g. carcinogen) or to be emitted in high quantities relevant to Petrochemical processes, will be included for evaluation. This is to ensure that the study focuses on the most critical compound which could be the main risk driver.
--	---	--	--	--	--

	<p>ADDITIONAL INFORMATION TO THE DEIA REFINERY AND PETROCHEMICAL INTEGRATED DEVELOPMENT (RAPID) PROJECT, PENERANG JOHOR, 2012 TO INCLUDE EURO 5 MOGAS AND OLEFIN TANK UNITS</p>	
	<p>CHAPTER 4 POTENTIAL ENVIRONMENTAL IMPACT AND MITIGATION MEASURES</p>	

4 POTENTIAL ENVIRONMENTAL IMPACT AND MITIGATION MEASURES

4.1 Introduction

The RAPID Refinery Cracker Complex was originally designed to produce diesel that meet the EURO 5 specifications and MOGAS (motor gasoline) that meet EURO 4 specifications. To upgrade and meet the EURO 5 MOGAS specifications, the Refinery and Cracker Complex has been expanded to include additional units as listed below:

1. 2nd Stage Cracked Naptha Hydrotreating (CNHT 2) Unit
2. Etherification Unit Tertiary-Armyl-Methyl-Ether (TAME) Unit
3. Isomerization Unit
4. Additional Storage Tanks which consist of:
 - i. Two Tertiary-Armyl-Methyl-Ether (TAME) storage tanks
 - ii. Two Isomerate storage tanks
 - iii. One Medium Cracked Naptha (MCN) storage tank

Besides that, there will be new olefin storage tankages located in the current refinery tank farms which consists of:



1. Four mounded bullets for Butadiene Storage
2. One Ethylene Tank
3. Four spheres for Propylene Storage

Details of the additional units are described in **Volume 1, Chapter 2**. This additional information report conducted studies to assess the impacts from these new process units and tank farms in the Refinery and Cracker Complex.



Table 4-1: List of Refinery Process Units as in RAPID DEIA 2012 and Additional Info to the RAPID DEIA 2016.

No.	Previous Refinery 2012	Abbreviation	Current Refinery 2016	Remarks
1.	Crude Distillation Unit	CDU	Maintained	
2.	Atmospheric Residue Desulfurization Unit	ARDU	Maintained	
3.	Kerosene Hydrotreating Unit	KHT	Maintained	
4.	Diesel Hydrotreating Unit	DHT	Maintained	
5.	Residue Fluidised Cracker Unit	RFCC	Maintained	
6.	LPG Treating Unit	LTU	Maintained	
7.	Cracked Naptha Hydrotreating Unit	CNHT	Maintained	
8.	Naptha Hydrotreating Unit	NHT	Maintained	
9.	Continuous Catalytic Reformer Unit	CCR	Maintained	
10.	Saturated Gas Plant	SGP	Maintained	
11.	Hydrogen Production Unit	HPU	Maintained	
12.	Amine Regeneration Unit	ARU	Maintained	
13.	Sour Water Stripping Unit	SWS	Maintained	
14.	Sulphur Recovery Unit & Tail Gas Treating Unit	SRU	Maintained	
15.	Hydrogen Collection and Distribution	HCDU	Maintained	
16.	Refinery Pressure Swing Adsorption	RPSA	Maintained	
17.		CNHT 2	2nd Stage Cracked Naptha Hydrotreating (CNHT) Unit	New units to upgrade and meet the EURO 5 MOGAS product specifications
18.		TAME	Etherification Unit Tertiary-Armyl-Methyl-Ether (TAME)	
19.		Isomerization	C5/C6 Isomerization Unit	
20.	Refinery Tank Farm	N/A	Additional Storage Tanks which consist of: i. Two new Tertiary-Armyl-Methyl-Ether (TAME) storage tanks ii. Two new isomerate storage tanks iii. One new Medium Cracked Naptha (MCN) storage tank	New storage tankages to store the feedstock to deleted Petrochemical units.
		N/A	New olefins storage tankages which consists of: i. Four mounded bullets for Butadiene Storage ii. One Ethylene Tank iii. Four sphere for Propylene Storage	

	<p align="center">ADDITIONAL INFORMATION TO THE DEIA REFINERY AND PETROCHEMICAL INTEGRATED DEVELOPMENT (RAPID) PROJECT, PENERANG JOHOR, 2012 TO INCLUDE EURO 5 MOGAS AND OLEFIN TANK UNITS</p>	
	<p align="center">CHAPTER 4 POTENTIAL ENVIRONMENTAL IMPACT AND MITIGATION MEASURES</p>	

Impact assessment to the surrounding environment from the addition of the new units will be conducted for the followings:

- a) Gaseous Emission
- b) Noise Study
- c) Discharged Effluent
- d) Waste Management and Chemical Handling Study
- e) Quantitative Risk Assessment
- f) Health Impact Assessment

There shall be no significant changes to the construction approach for the RAPID Refinery Cracker Complex and therefore the impact as assessed in RAPID DEIA 2012 still maintained.



The cumulative modeling and impact assessment for Refinery & Cracker Complex and overall RAPID Complex shall take into account process units which are changed and unchanged. Based on the assessments and findings on the impacts, appropriate and relevant control and mitigation measures shall be proposed in this section.

4.2 Impact Assessment Methodology

This section identifies the potential impacts that may arise as a result of the changes in the Refinery & Cracker Complex development and evaluates the significance of the impacts. In evaluating the significance (i.e. importance) of impacts, the following factors will be taken into consideration:

Impact Severity: The severity of an impact is a function of a range of considerations including impact magnitude, impact duration, impact extent, and legal & guideline compliance;

Nature and sensitivity of the receiving environment: The characteristics of the receptor/ resource will be taken into consideration with respect to its vulnerability/ sensitivity to an impact/ change.

 PETRONAS	ADDITIONAL INFORMATION TO THE DEIA REFINERY AND PETROCHEMICAL INTEGRATED DEVELOPMENT (RAPID) PROJECT, PENERANG JOHOR, 2012 TO INCLUDE EURO 5 MOGAS AND OLEFIN TANK UNITS	
	CHAPTER 4 POTENTIAL ENVIRONMENTAL IMPACT AND MITIGATION MEASURES	

With each identified impact, the appropriate mitigating measures will be recommended. The significance of the impacts will also be the basis of determining the potential residual impacts and the relevant environmental management plan to be adopted which will be discussed in the subsequent chapters.

The significance of each impact is determined by comparing the impact severity against the sensitivity of the receptor. The definition to the significance of the impact referred in this Additional Information Report is as follow:



i. Negligible or Minor (Insignificant)

Impacts assessed as Negligible or Minor will require no additional management or mitigation measures (on the basis that the magnitude of the impact is sufficiently small, or that the receptor is of low sensitivity and/or that adequate controls are already included in the project design). Negligible and Minor impacts are therefore deemed to be “Insignificant” and fall within the “No Action” criterion.

ii. Moderate or Major (Significant)

Impacts evaluated as “Moderate” or “Major” require the implementation of further management or mitigation measures. Major and Moderate impacts are therefore deemed to be “Significant”.

Major impacts always require further management or mitigation measures to minimise or reduce the impact to an acceptable level. An “acceptable level” is the reduction of a Major impact to a Moderate one after mitigation.

	ADDITIONAL INFORMATION TO THE DEIA REFINERY AND PETROCHEMICAL INTEGRATED DEVELOPMENT (RAPID) PROJECT, PENERANG JOHOR, 2012 TO INCLUDE EURO 5 MOGAS AND OLEFIN TANK UNITS	
	CHAPTER 4 POTENTIAL ENVIRONMENTAL IMPACT AND MITIGATION MEASURES	

iii. Short Term

Impacts that are predicted to last only for a limited period (e.g. during construction) but will cease on completion of the activity, or as a result of mitigation/ reinstatement measures and natural recovery.

iv. Long Term

Impacts that will continue over an extended period (e.g. operational noise) but cease when the Project stops operating. These will include impacts that may be intermittent or repeated rather than continuous if they occur over an extended time period.

To clearly identify the receptors that are most likely to be impacted by the activities during the operation phase, and for ease of reference when impacts and mitigating measures are discussed throughout this Chapter, the inventory and locations of the receptors of concern is as indicated in **Table 4-2** and **Figure 4-1**.



Table 4-2 : Inventory of the Sensitive Receptors 0-5 km from the RAPID Boundary

No.	Location (Relative to RAPID)	Sensitive Receptor
1	3-5 km west of RAPID	Kg. Pengelih
2	0-3 km west of RAPID	Pengelih Naval Base
3	0-3 km west of RAPID	Kg. Pengerang
4	0-3 km east of RAPID	Taman Rengit Jaya
5	0-3 km east of RAPID	Kg. Sg. Buntu
6	0-3 km east of RAPID	Kg. Bukit Buloh
7	3-5 km east of RAPID	Kg. Sg. Rengit
8	3-5 km east of RAPID	Kg. Bukit Gelugor
9	0-3 km north of RAPID	Kg. Lepau
10	3-5 km northwest of RAPID	Kg. Pasir Gogok

CHAPTER 4
POTENTIAL ENVIRONMENTAL IMPACT AND MITIGATION MEASURES



Figure 4-1: Location of Sensitive Receptors 0-5 km from the RAPID Boundary

	<p>ADDITIONAL INFORMATION TO THE DEIA REFINERY AND PETROCHEMICAL INTEGRATED DEVELOPMENT (RAPID) PROJECT, PENERANG JOHOR, 2012 TO INCLUDE EURO 5 MOGAS AND OLEFIN TANK UNITS</p>	
	<p>CHAPTER 4 POTENTIAL ENVIRONMENTAL IMPACT AND MITIGATION MEASURES</p>	

4.3 Impacts Assessment and Mitigation Measures

4.3.1 GASEOUS EMISSION

4.3.1.1 Introduction

The following sections discuss the impacts of air emissions during the operation phase of the project from various units of the Refinery Cracker Complex including the two additional units, EURO 5 MOGAS and Olefin Storage Tankages. Impacts of air emissions during the RAPID operational phase are assessed in detail by modelling and the findings are presented for the dispersion from the following emission sources:

- Emissions from additional unit of EURO 5 MOGAS and Olefin Storage Tanks;
- Cumulative emissions from the RAPID Refinery Cracker Complex;
- Cumulative emissions from the RAPID Complex.

For the above findings, emission dispersion is modelled based on the following scenario:

- Normal operating scenario;
- Abnormal operating scenario;
- Emergency scenario.

Details of the air dispersion modelling and definition of the operating scenarios are as in **Volume 1, Chapter 3** and **Volume 2, Appendix 1**.

4.3.1.2 Study Approach and Methodology

4.3.1.2.1 Applicable Regulatory Framework



Compliance to the ambient ground level concentration shall be referred to the Malaysian Ambient Air Quality Standards, 2013 (Standard 2020) (**Table 4-3**).

Table 4-3: Malaysian Ambient Air Quality Standards 2013 (Standard 2020)

No.	Pollutant	MAAQG	MAAQS 2013 (IT 2020)
1.	Sum of NO and NO ₂ expressed as NO ₂ <ul style="list-style-type: none"> • 1 hour • 24 hour 	320 µg/m ³ 75 µg/m ³	280 µg/m ³ 70 µg/m ³
2.	Sum of SO ₂ and SO ₃ expressed as SO ₂ <ul style="list-style-type: none"> • 1 hour • 24 hour 	350 µg/m ³ 105 µg/m ³	250 µg/m ³ 80 µg/m ³
3.	CO <ul style="list-style-type: none"> • 1 hour • 8 hour 	35,000 µg/m ³ 10,000 µg/m ³	30,000 µg/m ³ 10,000 µg/m ³
4.	TSP <ul style="list-style-type: none"> • 24 hour • Annual 	260 µg/m ³ 90 µg/m ³	- -
5.	PM ₁₀ <ul style="list-style-type: none"> • 24 hour • Annual 	150 µg/m ³ 50 µg/m ³	100 µg/m ³ 40 µg/m ³
6.	PM _{2.5} <ul style="list-style-type: none"> • 24 hour • Annual 	-	35 µg/m ³ 15 µg/m ³

Hydrogen Chloride, Ammonia, Mercury, Hydrogen Sulphide and VOCs are present in the emission sources and modelled for the dispersion. Since these pollutants do not have compliance limits under the Malaysian Ambient Air Quality Standards 2013 (Standard 2020), they will be evaluated under Health Impact Assessment (**Volume 2, Appendix 2**).

The regulatory compliance for stack emissions limit shall be designed to meet the emission limit as specified in the Clean Air Regulation (CAR) 2014 that is applicable for the refinery and cracker operation. **Table 4-4** shows the emission limits applicable for refineries. However, for Olefin Storage Tankages, the emissions do not fall under any of the source type.

	ADDITIONAL INFORMATION TO THE DEIA REFINERY AND PETROCHEMICAL INTEGRATED DEVELOPMENT (RAPID) PROJECT, PENERANG JOHOR, 2012 TO INCLUDE EURO 5 MOGAS AND OLEFIN TANK UNITS	
	CHAPTER 4 POTENTIAL ENVIRONMENTAL IMPACT AND MITIGATION MEASURES	

Nevertheless, the fugitive emission from both of the units are to be minimized in accordance to the DOE Malaysia’s guidance document entitled “*Best Available Techniques Guidance Document on Storage and Handling of Petroleum Products*”.



Table 4-4: Clean Air Regulation 2014 - Oil and Gas Industries: Refineries (All Sizes); Natural Gas Processing and Storage; Storage and Handling of Petroleum Products.

SOURCE	POLLUTANT	LIMIT VALUE	MONITORING
Claus plant	Sulphur	Recovery > 95%	periodic
Catalytic cracking	Total PM	40 mg/m ³	continuous
	Sum of SO ₂ and SO ₃ , expressed as SO ₂	1200 mg/m ³	continuous
Calcination	Total PM	40 mg/m ³	continuous

Notes:

1. Gases and vapors of organic substances such as hydrogen and hydrogen sulphide which escape from pressure relief fittings and blow-down systems shall be fed into a gas collecting system.
2. The collected gases shall be combusted in process furnaces if this is feasible. If this is not feasible, the gases shall be fed into a flare.
3. Waste gases continually produced by processing systems and waste gases occurring during the regeneration of catalysts, inspections and cleaning operations shall be fed into a post-combustion facility, or equivalent measures to reduce emissions shall be applied.
4. Gaseous and vaporous organic compounds shall be indicated as total organic carbon.
5. Fugitive emissions of volatile organic substances shall be minimized according to the respective Best Available Techniques Economically Achievable Guidance Document.
6. For compliance check a "Leakage Detection and Repair Program" shall be implemented as outlined in the Guidance Document on Leak Detection and Repair Program for Oil and Gas Industries in a manner as specified and approved by the Director General.

Details of methodology and study approach for Air Dispersion Modelling are further described in **Volume 1, Chapter 3**.

	<p>ADDITIONAL INFORMATION TO THE DEIA REFINERY AND PETROCHEMICAL INTEGRATED DEVELOPMENT (RAPID) PROJECT, PENERANG JOHOR, 2012 TO INCLUDE EURO 5 MOGAS AND OLEFIN TANK UNITS</p>	
	<p>CHAPTER 4 POTENTIAL ENVIRONMENTAL IMPACT AND MITIGATION MEASURES</p>	

4.3.1.2.2 Sources of Emission

4.3.1.2.2.1 Inventory of Emission Sources

- a) Emission sources from the new EURO 5 MOGAS Units Olefins Storage Tankages
- EURO 5 MOGAS unit contain only a unit of emission source and this unit operates based on continuous normal operation.
 - Olefins Storage Tankages cold flare will only be operational during abnormal operation.
 - The emission source for Olefins Storage Tankages unit is shown in **Table 4-5**.

The air schematic diagram for the new sources are shown in **Volume 1, Chapter 2**.



- b) Emission Sources from the Refinery and Cracker Complex and sources from other components in the RAPID Complex.

The list of emission sources from the Refinery and Cracker Complex and other Components within RAPID Complex are tabulated in **Table 4-5**. The data from other RAPID components and the model set up for the emission sources are assumed to be the same and remain unchanged in the air dispersion model setup.

Table 4-5: List of Air Emission Sources Identified for RAPID Complex

No.	Process Unit	Source ID	Description
A. Refinery Cracker Complex			
1.	Residue Fluidised Catalytic Cracking	RFCC1	Flue Gas Vent
2.		RFCC2	Flue Gas Vent
3.	Crude Distillation Unit	CDU1	Crude Heater
4.		CDU2	Crude Heater
5.	Atmospheric Residue Desulphurization Unit	ARDS1	Reactor Heater
6.		ARDS2	Reactor Heater
7.		ARDS3	Fractionator Feed Heater
8.		ARDS4	Reactor Heater
9.		ARDS5	Reactor Heater
10.		ARDS6	Fractionator Feed Heater
11.	Diesel Hydrotreating Unit	DHT1	Heater
12.	Kerosene Hydrotreating Unit	KHT1	Heater
13.	Cracked Naphtha Hydrotreating Unit	CNHT1	Heater
14.		CNHT2 (Catering for the EURO5 MOGAS unit)	Heater
15.	Naphtha Hydrotreating Unit	NHT1	Heater
16.	Continuous Catalytic Reformer	CCR1	Heater
17.		CCR2	Heater
18.		CCR3	Heater
19.		CCR4	Heater
20.		CCR5	Vent
21.	Hydrogen Production Unit	HPU1	Heater
22.		HPU2	Heater
23.		HPU3	Heater
24.		HPU4	Degasifier Vent
25.		HPU5	Degasifier Vent
26.		HPU6	Degasifier Vent
27.		HPU7	CO2 stripper vent
28.	Acid Flare System	AF1	Acid Flare
29.	Refinery Flare System	RF1	Main Flare
30.	Sulphur Recovery Unit	SRU1	Wet Scrubber
31.		SRU2	Wet Scrubber
32.		SRU3	Wet Scrubber
33.	Sulphur Solidification Units	SSU1	Flue Gas Vent
34.		SSU2	Flue Gas Vent
35.		SSU3	Flue Gas Vent
36.		SSU4	Flue Gas Vent
37.		SSU5	Flue Gas Vent
38.	Steam Cracker Complex	SCC1	Cracking Heater (normal)
39.		SCC2	Cracking Heater (normal)
40.		SCC3	Cracking Heater (normal)
41.		SCC4	Cracking Heater (normal)
42.		SCC5	Cracking Heater (normal)
43.		SCC6	Cracking Heater (decoking)
44.		PGH1	PGH Second Stage Reactor Vent
45.	SCCF1	Flare	
46.	Refinery Tank Farm	RTFF1	Flare
47.	Olefin Storage	CF1	Cold Flare
B. Petrochemical Complex			
1.	EOEG Thermal Oxidiser	TOX1	Thermal Oxidiser
2.	Polymer Tank Farm Thermal Oxidiser	TOX4	Thermal Oxidiser
3.	SCC Tank Farm Thermal Oxidiser	TOX6	Thermal Oxidiser
4.	PP Regenerative Thermal Oxidiser	TOX7	Thermal Oxidiser
5.	C4-INA Boiler	BOILER1	Boiler
6.	Petrochemical Common Flare	PCF1	Flare
7.	C4-INA Flare	C4-INA Flare	Flare
C. Pengerang Cogeneration Plant (PCP)			
1.	HRSG Main Stack	PCP1	Vent
2.	HRSG Main Stack	PCP2	Vent
3.	HRSG Main Stack	PCP3	Vent
4.	HRSG Main Stack	PCP4	Vent
D. Utilities			
1.	Boilers HP Stack	Utilities1	Vent
2.	Boilers HP Stack	Utilities2	Vent
3.	Boilers HHP Stack	Utilities3	Vent

Note: Vent is also commonly and interchangeably known as Stack, Chimney or Exhaust in this study

	ADDITIONAL INFORMATION TO THE DEIA REFINERY AND PETROCHEMICAL INTEGRATED DEVELOPMENT (RAPID) PROJECT, PENERANG JOHOR, 2012 TO INCLUDE EURO 5 MOGAS AND OLEFIN TANK UNITS	
	CHAPTER 4 POTENTIAL ENVIRONMENTAL IMPACT AND MITIGATION MEASURES	

Overall, there are 47 emission sources from the Refinery Cracker Complex and a total of 61 emission sources from RAPID Complex. The summary of emission sources from the RAPID Complex are summarized as follow:

Table 4-6: Summary of Emission Sources from RAPID Complex

No.	Process Unit	Emission Sources
1.	EURO5 MOGAS	1 Heater
2.	Olefin Storage Tankages	1 Cold Flare
3.	RFCC, LTU and PRU	2 Flue Gas Vents
4.	CDU, ARDS, HCDU, FOS	8 Heaters
5.	DHT, KHT, CNHT, CCR, HPU, AF1, RF1	11 Heaters, 5 Vents and 2 Flares
6.	SRU, SSU	3 Scrubber, 5 Vents
7.	SCC	6 Heaters, 1 Vent and 1 Flare
8.	Refinery Tank Farm	1 Flare
9.	Petrochemical Complex	4 Thermal oxidiser, 1 Boiler and 2 Flares
10.	Pengerang Cogeneration Plant (PCP)	4 Vents
11.	Utilities	3 Vents

Note: Vent is also commonly and interchangeably known as Stack, Chimney or Exhaust in this study



4.3.1.3 Modelling Findings

4.3.1.3.1 Normal Operating Conditions

The modeling data input for normal operating conditions is as tabulated in **Table 4-7**. The modeling data input for other components within RAPID Complex is shown in **Table 4-8**.

Data input is based on design data input for continuous emissions when plants are in operation with normal design conditions.

RAPID Complex design philosophy ensures that VOCs and acid gases containing toxic pollutants are combusted at the thermal oxidizers or acid flare

	<p align="center">ADDITIONAL INFORMATION TO THE DEIA REFINERY AND PETROCHEMICAL INTEGRATED DEVELOPMENT (RAPID) PROJECT, PENGERANG JOHOR, 2012 TO INCLUDE EURO 5 MOGAS AND OLEFIN TANK UNITS</p>	
	<p align="center">CHAPTER 4 POTENTIAL ENVIRONMENTAL IMPACT AND MITIGATION MEASURES</p>	



to ensure only traces of these pollutants are released into the atmosphere and meeting compliance and health limit. All vents during the emergency conditions (pressure built up/fire/power failure event) are routed to the flare system.

a) Emission from the new EURO 5 MOGAS Units and Olefin Storage Tank

- For normal operating conditions, modelling findings indicate all pollutants emitted from EURO5 MOGAS expansion meets the Malaysia Ambient Air Quality Standards (MAAQS) Standard 2020 at all identified sensitive receptor locations. Vent is routed from the CHNT2 heater unit to atmosphere from this emission source;
- There is no continuous emission source from Olefin Storage tankages as vent is routed to either the Cold Flare or routed to the Refinery Tank Farm Flare. The cold flare system is a compression system that is dedicated to collect vents from pressurized ethylene storage system to be released intermittently. Hence, this dispersion will be considered under abnormal and emergency scenario.

b) Cumulative Emission from RAPID Refinery Cracker Complex

- For normal operating conditions, modelling findings indicate all pollutants meets the Malaysia Ambient Air Quality Standards (MAAQS) Standard 2020 at all identified sensitive receptor locations.
- The max ground level concentration (GLC) for all pollutants are below the MAAQS Standard 2020 except for NO₂ where the GLC limit is exceeded at Bukit Pelali and Bukit Pengerang.
- The NO₂ Tier 1 and NO₂ Tier 3 GLC of 791.5 µg/m³ (Bukit Pelali) and 483.1 µg/m³ (Bukit Pelali) respectively exceeded the 1 hour averaging limit of 280 µg/m³. With percentile

	<p>ADDITIONAL INFORMATION TO THE DEIA REFINERY AND PETROCHEMICAL INTEGRATED DEVELOPMENT (RAPID) PROJECT, PENGERANG JOHOR, 2012 TO INCLUDE EURO 5 MOGAS AND OLEFIN TANK UNITS</p>	
	<p>CHAPTER 4 POTENTIAL ENVIRONMENTAL IMPACT AND MITIGATION MEASURES</p>	

modelling of NO₂, approximately 0.4 percentile or translated into probability to occur at 7 days in every 5 years operating period.

- The NO₂ Tier 1 GLC of 98.2 µg/m³ (Bukit Pengerang) exceeded the 24 hours averaging limit of 70 µg/m³. With percentile modelling of NO₂, approximately 0.2 percentile or translated into probability to occur at 4 days in every 5 years operating period. NO₂ emission contribution for each source in the Refinery Cracker Complex by percentage is tabulated in **Table 4-9**.



Table 4-7: Inventory of Current Air Pollution Sources and Emission Characteristics for the RAPID Refinery Cracker Complex (Normal Operation)

No	Source ID	Description	Stack Height (m)	Diameter (m)	Exit Velocity (m/s)	Exit Temperature (°C)	Volume Flow Rate (Nm ³ /hr)	UTM Coordinate (Zone 48 N) (m)		Emission Rate (g/s)								
								X	Y	PM ₁₀	PM _{2.5}	NO ₂	CO	SO ₂	NH ₃	NM VOC	Methanol	H ₂ S
1	RFCC1	Flue Gas Stack	109	4.5	14.58	60.55	683313	407078.30	151599.36	1.5	0.460	46.4	32.0	25.0	-	-	-	-
2	RFCC2	Flue Gas Stack	109	4.5	14.58	60.55	683313	407308.57	151599.36	1.5	0.460	46.4	32.0	25.0	-	-	-	-
3	CDU1	Crude Heater	67	2.87	12.27	201	164621	407293.38	151114.65	0.089	0.089	2.9	1.0	0.572	-	-	-	-
4	CDU2	Crude Heater	67	2.87	12.27	201	164621	407293.38	151066.95	0.089	0.089	2.9	1.0	0.572	-	-	-	-
5	ARDS1	Reactor Heater	61.5	1.15	12.51	164	29229	407136.48	151467.32	0.019	0.019	0.389	0.2	0.100	-	-	-	-
6	ARDS2	Reactor Heater	61.5	1.15	12.51	164	29229	407019.64	151466.58	0.019	0.019	0.389	0.2	0.100	-	-	-	-
7	ARDS3	Fractionator Feed Heater	50	0.65	8.64	178	6249	407022.33	151249.38	0.008	0.008	0.169	0.1	0.044	-	-	-	-
8	ARDS4	Reactor Heater	61.5	1.15	8.68	164	20280	406963.68	151466.59	0.019	0.019	0.389	0.2	0.100	-	-	-	-
9	ARDS5	Reactor Heater	61.5	1.15	8.68	164	20280	407192.46	151467.33	0.019	0.019	0.389	0.2	0.100	-	-	-	-
10	ARDS6	Fractionator Feed Heater	50	0.65	8.64	178	6249	407200.33	151249.39	0.008	0.008	0.169	0.1	0.044	-	-	-	-
11	DHT1	Diesel Hydrotreating (DHT)	47.6	1.68	7.62	254	31509	407623.24	151616.53	0.016	0.010	1.4	-	0.200	-	0.069	-	-
12	KHT1	Kerosene Hydrotreating (KHT)	39.85	0.88	13	325	12998	407626.81	151726.48	0.007	0.004	0.060	-	0.086	-	0.029	-	-
13	CNHT1	Cracked Naphtha Hydrotreating (CNHT)	51	0.66	15	348	8124	407626.81	151831.96	0.004	0.003	0.350	-	0.052	-	0.018	-	-
14	CNHT2	Cracked Naphtha Hydrotreating (CNHT) – EURO5 MOGAS unit	51	0.66	15	348	9623	407717.05	151757.31	0.011	0.011	0.744	0.117	0.031	-	0.022	-	-
15	NHT1	Naphtha Hydrotreating (NHT)	38.3	0.88	12	315	12203	407593.93	151892.74	0.006	0.004	0.517	-	0.078	-	0.027	-	-
16	CCR1	Continuous Catalytic Reformer (CCR)	66	1.95	7.5	174.7	52051	407661.00	151956.00	0.025	0.015	3.3	-	0.311	-	0.107	-	-
17	CCR2	Continuous Catalytic Reformer (CCR)	66	1.95	7.5	174.7	52051	407661.00	151956.00	0.025	0.015	3.3	-	0.311	-	0.107	-	-
18	CCR3	Continuous Catalytic Reformer (CCR)	66	1.95	7.5	174.7	52051	407661.00	151956.00	0.025	0.015	3.3	-	0.311	-	0.107	-	-



CHAPTER 4
POTENTIAL ENVIRONMENTAL IMPACT AND MITIGATION MEASURES

No	Source ID	Description	Stack Height (m)	Diameter (m)	Exit Velocity (m/s)	Exit Temperature (°C)	Volume Flow Rate (Nm ³ /hr)	UTM Coordinate (Zone 48 N) (m)		Emission Rate (g/s)								
								X	Y	PM ₁₀	PM _{2.5}	NO ₂	CO	SO ₂	NH ₃	NMVOC	Methanol	H ₂ S
19	CCR4	Continuous Catalytic Reformer (CCR)	66	1.95	7.5	174.7	52051	407661.00	151956.00	0.025	0.015	3.3	-	0.311	-	0.107	-	-
20	CCR5	Continuous Catalytic Reformer (CCR)	23.2	0.64	0.46	44	344	407661.00	151948.88	-	-	-	-	-	-	-	-	-
21	HPU1	Hydrogen Production (HPU)	45	2.75	20.1	150	277435	407510.45	151421.28	-	-	4.8	2.5	0.260	-	0.586	-	-
22	HPU2	Hydrogen Production (HPU)	45	2.75	20.1	150	277435	407605.62	151421.21	-	-	4.8	2.5	0.260	-	0.586	-	-
23	HPU3	Hydrogen Production (HPU)	45	2.75	20.1	150	277435	407707.59	151421.15	-	-	4.8	2.5	0.260	-	0.586	-	-
24	HPU4	Hydrogen Production (HPU) Degasifier Vent	21.2	0.08	10.224	40	161	407476.60	151491.27	-	-	-	0.527	-	0.002	-	-	-
25	HPU5	Hydrogen Production (HPU) Degasifier Vent	21.2	0.08	10.224	40	161	407571.68	151491.21	-	-	-	0.527	-	0.002	-	0.045	-
26	HPU6	Hydrogen Production (HPU) Degasifier Vent	21.2	0.08	10.224	40	161	407667.65	151491.15	-	-	-	0.527	-	0.002	-	0.045	-
28	HPU7	Hydrogen Production (HPU) CO ₂ stripper vent	22.2	0.25	22	50	3286	407621.66	151342.13	-	-	-	1.4	-	-	-	0.045	-
29	SRU1	SRU Unit 1	105	2.5	8.38	74.3	116419	407213.08	152216.63	-	-	10.3	2.3	3.4	-	-	-	0.167
30	SRU2	SRU Unit 2	105	2.5	8.38	74.3	116419	407312.43	152216.63	-	-	10.3	2.3	3.4	-	-	-	0.167
31	SRU3	SRU Unit 3	105	2.5	8.38	74.3	116419	407417.96	152216.63	-	-	10.3	2.3	3.4	-	-	-	0.167
32	SSU1	SSU Unit 1	12.1	0.39	15.32	80	5096	407711.37	152231.87	-	-	-	-	0.083	-	-	-	-
33	SSU2	SSU Unit 2	12.1	0.39	15.32	80	5096	407711.37	152217.22	-	-	-	-	0.083	-	-	-	-
34	SSU3	SSU Unit 3	12.1	0.39	15.32	80	5096	407711.37	152201.93	-	-	-	-	0.083	-	-	-	-
35	SSU4	SSU Unit 4	12.1	0.39	15.32	80	5096	407711.37	152190.08	-	-	-	-	0.083	-	-	-	-
36	SSU5	SSU Unit 5	12.1	0.39	15.32	80	5096	407711.37	152178.23	-	-	-	-	0.083	-	-	-	-
37	SCC1	Cracking Heater (normal)	59.2	3.3	10.1	112.85	220067	406166.00	151560.20	0.145	0.116	8.6	2.6	-	-	-	-	-
38	SCC2	Cracking Heater (normal)	59.2	3.3	10.1	112.85	220067	406166.00	151541.20	0.145	0.116	8.6	2.6	-	-	-	-	-



No	Source ID	Description	Stack Height (m)	Diameter (m)	Exit Velocity (m/s)	Exit Temperature (°C)	Volume Flow Rate (Nm ³ /hr)	UTM Coordinate (Zone 48 N) (m)		Emission Rate (g/s)								
								X	Y	PM ₁₀	PM _{2.5}	NO ₂	CO	SO ₂	NH ₃	NMVOC	Methanol	H ₂ S
39	SCC3	Cracking Heater (normal)	59.2	3.3	10	105.85	221913	406166.00	151522.00	0.147	0.117	8.7	2.6	-	-	-	-	-
40	SCC4	Cracking Heater (normal)	59.2	3.3	10	105.85	221913	406166.00	151502.50	0.147	0.117	8.7	2.6	-	-	-	-	-
41	SCC5	Cracking Heater (normal)	59.2	3.3	10	105.85	221913	406165.90	151483.10	0.147	0.117	8.7	2.6	-	-	-	-	-
42	SCC6	Cracking Heater (decoking)	59.2	3.3	11.1	299.85	162926	406165.90	151463.70	1.8	1.8	7.5	1.8	-	-	-	-	-

Table 4-8: Inventory of Emission Sources Form Other RAPID Complex Components

No	Source ID	Description	Stack Height (m)	Diameter (m)	Exit Velocity (m/s)	Exit Temperature (C)	UTM Coordinate (Zone 48 N) (m)		UTM Coordinate (Zone 48 N) (m)									
							X	Y	PM ₁₀	PM _{2.5}	NO ₂	CO	SO ₂	NH ₃	NMVOC	Methanol	H ₂ S	
A. Petrochemical Complex																		
1	TOX1	EOEG Thermal Oxidiser	30	1	8	200	405246.36	151618.80	0.126	0.072	1.0	3.2	-	-	-	-	-	
2	TOX4	Polymer Tank Farm Thermal Oxidiser	45	1	8	200	405747.31	150913.71	0.136	0.078	1.0	3.4	-	-	-	-	-	
3	TOX6	SCC Tank Farm Thermal Oxidiser	45	1	8	200	406021.25	151809.11	0.136	0.078	1.0	3.4	-	-	-	-	-	
4	TOX7	PP Regenerative Thermal Oxidiser	45	1	8	200	406028.56	150538.71	0.136	0.078	1.0	3.4	-	-	-	-	-	
5	BOILER1	C4 INA Boiler	25	1.3	9.84	150	406034.75	151157.79	0.316	0.180	2.4	8.0	-	-	-	-	-	
6	FLARE1	C4 INA Flare	100	0.6	20 ^{Note2}	1000 ^{Note2}	406072.84	151145.05	-	-	19.6	106.8	-	-	-	-	-	
7	PCF1	Petrochemical Common Flare	125	1.5	20 ^{Note2}	1000 ^{Note2}	406036.41	152179.97	-	-	0.083	0.483	-	-	-	-	-	
B. Pengerang Cogeneration Plant (PCP)																		
1	PCP1	HRSG Main Stack	40	8.5	51.48	680	408283.40	152056.60	2.2	2.2	43.5	27.4	1.1	-	-	-	-	
2	PCP2	HRSG Main Stack	40	8.5	51.48	680	408239.58	152056.60	2.2	2.2	43.5	27.4	1.1	-	-	-	-	
3	PCP3	HRSG Main Stack	40	8.5	51.48	680	408102.58	152056.60	2.2	2.2	43.5	27.4	1.1	-	-	-	-	
4	PCP4	HRSG Main Stack	40	8.5	51.48	680	408054.81	152056.60	2.2	2.2	43.5	27.4	1.1	-	-	-	-	
C. Utilities																		
1	Utilities1	Boilers HP	68	2.5	8.82	270	406503.95	151668.69	0.081	0.081	5.0	0.811	0.203	-	-	-	-	
2	Utilities2	Boilers HP	68	2.5	8.82	270	406544.47	151669.23	0.081	0.081	5.0	0.811	0.203	-	-	-	-	
3	Utilities3	Boilers HHP	83	3.5	12.69	144	406464.34	151668.7	0.297	0.297	5.0	3.0	0.747	-	-	-	-	

Note:

Note1: Effective flare calculation

Note2: Default value

Table 4-9: NO₂ Emission Contribution by Loading from Sources in Refinery and Cracker Complex

No.	Process Unit	Source ID	Total of NO ₂ emission (g/s)	Total of NO ₂ emission load (Kg/hr)	Percentage (%)
1.	Residue Fluidised Catalytic Cracking	RFCC1	46.4	167.0	22
2.		RFCC2	46.4	167.0	22
3.	Crude Distillation Unit	CDU1	2.9	10.5	1
4.		CDU2	2.9	10.5	1
5.	Atmospheric Residue Desulphurization Unit	ARDS1	0.389	1.4	<1
6.		ARDS2	0.389	1.4	<1
7.		ARDS3	0.169	0.6	<1
8.		ARDS4	0.389	1.4	<1
9.		ARDS5	0.389	1.4	<1
10.		ARDS6	0.169	0.6	<1
11.	Diesel Hydrotreating Unit	DHT1	1.4	5.0	1
12.	Kerosene Hydrotreating Unit	KHT1	0.060	0.2	<1
13.	Cracked Naphtha Hydrotreating Unit	CNHT1	0.350	1.3	<1
14.		CNHT2	0.744	2.7	<1
15.	Naphtha Hydrotreating Unit	NHT1	0.517	1.9	<1
16.	Continuous Catalytic Reformer	CCR1	3.3	12.0	2
17.		CCR2	3.3	12.0	2
18.		CCR3	3.3	12.0	2
19.		CCR4	3.3	12.0	2
20.		CCR5	-	0.0	0
21.	Hydrogen Production Unit	HPU1	4.8	17.4	2
22.		HPU2	4.8	17.4	2
23.		HPU3	4.8	17.4	2
24.		HPU4	-	-	0
25.		HPU5	-	-	0
26.		HPU6	-	-	0
27.		HPU7	-	-	0
28.	Sulphur Recovery Unit	SRU1	10.3	37.1	5
29.		SRU2	10.3	37.1	5
30.		SRU3	10.3	37.1	5
31.	Sulphur Solidification Units	SSU1	-	-	0
32.		SSU2	-	-	0
33.		SSU3	-	-	0
34.		SSU4	-	-	0
35.		SSU5	-	-	0
36.	Steam Cracker Complex	SCC1	8.6	30.9	4
37.		SCC2	8.6	30.9	4
38.		SCC3	8.7	31.2	4
39.		SCC4	8.7	31.2	4
40.		SCC5	8.7	31.2	4
41.		SCC6	7.5	27.0	4
TOTAL			212.9	766.5	100

Table 4-10: NO₂ Emission Contribution for each Refinery Cracker Complex source to the Maximum GLC

Pollutant	Process Units	Maximum Concentration (µg/m ³)	Location
Maximum NO₂ Concentration (µg/m³) - Tier 1 - 1 Hour	RFCC, LTU and PRU	134.3	Within RAPID
	CDU, ARDS, HCDU AND FOS	85.9	Bukit Pelali
	DHT, KHT, CNHT, CCR and HPU	691.9 ^{Note1}	Bukit Pelali
	SRU and SSU	72.9	Within RAPID
	Steam Cracker Complex (SCC)	470.7	Bukit Pelali
	Refinery Tank Farm	-	-
	Olefins Storage Tankages	-	-
	EURO5 MOGAS	25.8	Bukit Pengerang
Maximum NO₂ Concentration (µg/m³) - Tier 1 - 24 Hours	RFCC, LTU and PRU	24.6	Within RAPID
	CDU, ARDS, HCDU AND FOS	8.4	Bukit Pelali
	DHT, KHT, CNHT, CCR and HPU	55.2 ^{Note1}	Bukit Pengerang
	SRU and SSU	15.6	Within RAPID
	Steam Cracker Complex (SCC)	50.5	Bukit Pengerang
	Refinery Tank Farm	-	-
	Olefins Storage Tankages	-	-
	EURO5 MOGAS	-	-
Maximum NO₂ Concentration (µg/m³) - Tier 3 - 1 Hour	RFCC, LTU and PRU	89.1	Within RAPID
	CDU, ARDS, HCDU AND FOS	60.7	Bukit Pelali
	DHT, KHT, CNHT, CCR and HPU	396.4	Bukit Pelali
	SRU and SSU	60.3	Within RAPID
	Steam Cracker Complex (SCC)	243.7 ^{Note1}	Bukit Pelali
	Refinery Tank Farm	-	-
	Olefins Storage Tankages	-	-
	EURO5 MOGAS	-	-

Note:

Note1: Highest concentration

c) Cumulative Emission from RAPID Complex

- All pollutants meet the Malaysia Ambient Air Quality Standards (MAAQS) Standard 2020 at all identified sensitive receptor locations.
- The max ground level concentration (GLC) for all pollutants are below the MAAQS Standard 2020 except for NO₂ where the GLC limit is exceeded at Bukit Pelali and Bukit Pengerang.
- The NO₂ Tier 1 and NO₂ Tier 3 GLC of 808.3 µg/m³ (Bukit Pelali) and 526.9 µg/m³ (Bukit Pelali) exceeded the 1 hour averaging limit of 280 µg/m³. With percentile modelling, approximately 0.5 percentile or translated into probability to occur at 9 days in every 5 years operating period.
- The NO₂ Tier 1 GLC of 115.5 (Bukit Pengerang) exceeded the 24 hours averaging limit of 70 µg/m³ at approximately 0.3 percentile or translated into probability to occur at 5 days in every 5 years operating period. Tabulated below are the predicted gaseous concentrations at the sensitive and discrete receptors along with the contours of the predicted gaseous concentrations in the 5-km radius receptor grid.

NO₂ emission contribution for each complex by total amount and percentage is tabulated in **Table 4-11** below:

Table 4-11: NO₂ Emission Contribution from Each Complex in RAPID

No.	Sources	Total of NO ₂ emission rate (g/s)	Total of NO ₂ emission load (Kg/hr)	Percentage (%)
1.	Refinery Cracker Complex	212.9	766.5	50
2.	Petrochemical Complex	26.1	94.1	6
3.	Pengerang Cogeneration Plant (PCP)	174.0	626.4	41
4.	Utilities	15	54.0	4
TOTAL		428.1	1541.0	100



Table 4-12: Predicted Incremental GLC and Cumulative GLC for EURO 5 MOGAS Unit (Normal Operation)

No	Scenario	Receptor	Baseline (Oct 2012)	Normal Operating Scenario		
				Max Incremental ($\mu\text{g}/\text{m}^3$)	Receptor Incremental ($\mu\text{g}/\text{m}^3$)	Cumulative GLC ($\mu\text{g}/\text{m}^3$)
	EURO 5 MOGAS Pollutant: PM₁₀ 24 hrs Average Limit: $100 \mu\text{g}/\text{m}^3$	Tg. Pengelih	24	0.034 (Bukit Pengerang)	0.0012	24.0
		Pengelih Naval Base	24		0.0339	24.0
		Kg. Pengerang	36		0.0019	36.0
		Kg. Sg. Kapal	25		0.0068	25.0
		Taman Rengit Jaya	38		0.0050	38.0
		Kg. Sg. Buntu	28		0.0039	28.0
		Kg. Bukit Buloh	31		0.0017	31.0
		Kg. Sg. Rengit	20		0.0014	20.0
		Kg. Bukit Gelugor	22		0.0015	22.0
		Kg. Lepau	35		0.0017	35.0
		Kg. Pasir Gokok	20		0.0011	20.0
	EURO 5 MOGAS Pollutant: PM₁₀ Annual Average Limit: $40 \mu\text{g}/\text{m}^3$	Tg. Pengelih	NM	0.004 (Within RAPID)	0.00003	NA
		Pengelih Naval Base	NM		0.00050	NA
		Kg. Pengerang	NM		0.00004	NA
		Kg. Sg. Kapal	NM		0.00034	NA
		Taman Rengit Jaya	NM		0.00032	NA
		Kg. Sg. Buntu	NM		0.00026	NA
		Kg. Bukit Buloh	NM		0.00014	NA
		Kg. Sg. Rengit	NM		0.00009	NA
		Kg. Bukit Gelugor	NM		0.00007	NA
		Kg. Lepau	NM		0.00011	NA
		Kg. Pasir Gokok	NM		0.00004	NA



CHAPTER 4
POTENTIAL ENVIRONMENTAL IMPACT AND MITIGATION MEASURES

No	Scenario	Receptor	Baseline (Oct 2012)	Normal Operating Scenario		
				Max Incremental ($\mu\text{g}/\text{m}^3$)	Receptor Incremental ($\mu\text{g}/\text{m}^3$)	Cumulative GLC ($\mu\text{g}/\text{m}^3$)
	EURO 5 MOGAS Pollutant: $\text{PM}_{2.5}$ 24 hrs Average Limit: $35 \mu\text{g}/\text{m}^3$	Tg. Pengelih	NM	0.034 (Bukit Pengerang)	0.0012	NA
		Pengelih Naval Base	NM		0.0339	NA
		Kg. Pengerang	NM		0.0019	NA
		Kg. Sg. Kapal	NM		0.0068	NA
		Taman Rengit Jaya	NM		0.0050	NA
		Kg. Sg. Buntu	NM		0.0039	NA
		Kg. Bukit Buloh	NM		0.0017	NA
		Kg. Sg. Rengit	NM		0.0014	NA
		Kg. Bukit Gelugor	NM		0.0015	NA
		Kg. Lepau	NM		0.0017	NA
		Kg. Pasir Gogok	NM		0.0011	NA
	EURO 5 MOGAS Pollutant: $\text{PM}_{2.5}$ Annual Average Limit: $15 \mu\text{g}/\text{m}^3$	Tg. Pengelih	NM	0.004 (Within RAPID)	0.00003	NA
		Pengelih Naval Base	NM		0.00050	NA
		Kg. Pengerang	NM		0.00004	NA
		Kg. Sg. Kapal	NM		0.00034	NA
		Taman Rengit Jaya	NM		0.00032	NA
		Kg. Sg. Buntu	NM		0.00026	NA
		Kg. Bukit Buloh	NM		0.00014	NA
		Kg. Sg. Rengit	NM		0.00009	NA
		Kg. Bukit Gelugor	NM		0.00007	NA
		Kg. Lepau	NM		0.00011	NA
		Kg. Pasir Gogok	NM		0.00004	NA



CHAPTER 4
POTENTIAL ENVIRONMENTAL IMPACT AND MITIGATION MEASURES

No	Scenario	Receptor	Baseline (Oct 2012)	Normal Operating Scenario		
				Max Incremental ($\mu\text{g}/\text{m}^3$)	Receptor Incremental ($\mu\text{g}/\text{m}^3$)	Cumulative GLC ($\mu\text{g}/\text{m}^3$)
	EURO 5 MOGAS Pollutant: NO₂ Tier1 1 hr Average Limit: 280 $\mu\text{g}/\text{m}^3$	Tg. Pengelih	<5	25.8 (Bukit Pengerang)	0.824	5.8
		Pengelih Naval Base	<5		25.8	30.8
		Kg. Pengerang	<5		1.2	6.2
		Kg. Sg. Kapal	<5		1.7	6.7
		Taman Rengit Jaya	<5		2.0	7.0
		Kg. Sg. Buntu	<5		1.8	6.8
		Kg. Bukit Buloh	<5		1.8	6.8
		Kg. Sg. Rengit	ND		1.6	1.6
		Kg. Bukit Gelugor	<5		1.6	6.6
		Kg. Lepau	<5		1.9	6.9
		Kg. Pasir Gogok	ND		1.1	1.1
	EURO 5 MOGAS Pollutant: NO₂ Tier1 24 hrs Average Limit: 70 $\mu\text{g}/\text{m}^3$	Tg. Pengelih	NM	2.3 (Bukit Pengerang)	0.083	NA
		Pengelih Naval Base	NM		2.3	NA
		Kg. Pengerang	NM		0.125	NA
		Kg. Sg. Kapal	NM		0.454	NA
		Taman Rengit Jaya	NM		0.333	NA
		Kg. Sg. Buntu	NM		0.262	NA
		Kg. Bukit Buloh	NM		0.111	NA
		Kg. Sg. Rengit	NM		0.092	NA
		Kg. Bukit Gelugor	NM		0.102	NA
		Kg. Lepau	NM		0.115	NA
		Kg. Pasir Gogok	NM		0.072	NA



CHAPTER 4
POTENTIAL ENVIRONMENTAL IMPACT AND MITIGATION MEASURES

No	Scenario	Receptor	Baseline (Oct 2012)	Normal Operating Scenario		
				Max Incremental ($\mu\text{g}/\text{m}^3$)	Receptor Incremental ($\mu\text{g}/\text{m}^3$)	Cumulative GLC ($\mu\text{g}/\text{m}^3$)
	EURO 5 MOGAS Pollutant: SO₂ 1 hr Average Limit: 250 $\mu\text{g}/\text{m}^3$	Tg. Pengelih	<5	1.1 (Bukit Pengerang)	0.034	5.0
		Pengelih Naval Base	<5		1.076	6.1
		Kg. Pengerang	<5		0.051	5.1
		Kg. Sg. Kapal	<5		0.071	5.1
		Taman Rengit Jaya	<5		0.082	5.1
		Kg. Sg. Buntu	<5		0.076	5.1
		Kg. Bukit Buloh	<5		0.076	5.1
		Kg. Sg. Rengit	ND		0.067	0.1
		Kg. Bukit Gelugor	<5		0.066	5.1
		Kg. Lepau	<5		0.078	5.1
		Kg. Pasir Gogok	ND		0.046	0.0
	EURO 5 MOGAS Pollutant: SO₂ 24 hrs Average Limit: 80 $\mu\text{g}/\text{m}^3$	Tg. Pengelih	NM	0.095 (Bukit Pengerang)	0.003	NA
		Pengelih Naval Base	NM		0.095	NA
		Kg. Pengerang	NM		0.005	NA
		Kg. Sg. Kapal	NM		0.019	NA
		Taman Rengit Jaya	NM		0.014	NA
		Kg. Sg. Buntu	NM		0.011	NA
		Kg. Bukit Buloh	NM		0.005	NA
		Kg. Sg. Rengit	NM		0.004	NA
		Kg. Bukit Gelugor	NM		0.004	NA
		Kg. Lepau	NM		0.005	NA
		Kg. Pasir Gogok	NM		0.003	NA



CHAPTER 4
POTENTIAL ENVIRONMENTAL IMPACT AND MITIGATION MEASURES

No	Scenario	Receptor	Baseline (Oct 2012)	Normal Operating Scenario		
				Max Incremental ($\mu\text{g}/\text{m}^3$)	Receptor Incremental ($\mu\text{g}/\text{m}^3$)	Cumulative GLC ($\mu\text{g}/\text{m}^3$)
	EURO 5 MOGAS Pollutant: CO 1 hr Average Limit: 30,000 $\mu\text{g}/\text{m}^3$	Tg. Pengelih	NM	4.1 (Bukit Pengerang)	0.130	NA
		Pengelih Naval Base	NM		4.1	NA
		Kg. Pengerang	NM		0.193	NA
		Kg. Sg. Kapal	NM		0.270	NA
		Taman Rengit Jaya	NM		0.308	NA
		Kg. Sg. Buntu	NM		0.288	NA
		Kg. Bukit Buloh	NM		0.286	NA
		Kg. Sg. Rengit	NM		0.254	NA
		Kg. Bukit Gelugor	NM		0.250	NA
		Kg. Lepau	NM		0.296	NA
		Kg. Pasir Gogok	NM		0.172	NA
	EURO 5 MOGAS Pollutant: CO 8 hrs Average Limit: 10,000 $\mu\text{g}/\text{m}^3$	Tg. Pengelih	<100	1.1 (Bukit Pengerang)	0.032	100.0
		Pengelih Naval Base	<100		1.1	101.1
		Kg. Pengerang	<100		0.050	100.1
		Kg. Sg. Kapal	<100		0.148	100.1
		Taman Rengit Jaya	<100		0.116	100.1
		Kg. Sg. Buntu	<100		0.090	100.1
		Kg. Bukit Buloh	<100		0.044	100.0
		Kg. Sg. Rengit	ND		0.035	0.0
		Kg. Bukit Gelugor	<100		0.031	100.0
		Kg. Lepau	<100		0.052	100.1
		Kg. Pasir Gogok	ND		0.023	0.0
	EURO 5 MOGAS Pollutant: NMVOC	Tg. Pengelih	NM	0.764 (Bukit Pengerang)	0.024	NA
		Pengelih Naval Base	NM		0.764	NA



CHAPTER 4
POTENTIAL ENVIRONMENTAL IMPACT AND MITIGATION MEASURES

No	Scenario	Receptor	Baseline (Oct 2012)	Normal Operating Scenario		
				Max Incremental ($\mu\text{g}/\text{m}^3$)	Receptor Incremental ($\mu\text{g}/\text{m}^3$)	Cumulative GLC ($\mu\text{g}/\text{m}^3$)
	1 hr Average Limit: NA	Kg. Penerang	NM		0.036	NA
		Kg. Sg. Kapal	NM		0.051	NA
		Taman Rengit Jaya	NM		0.058	NA
		Kg. Sg. Buntu	NM		0.054	NA
		Kg. Bukit Buloh	NM		0.054	NA
		Kg. Sg. Rengit	NM		0.048	NA
		Kg. Bukit Gelugor	NM		0.047	NA
		Kg. Lepau	NM		0.056	NA
		Kg. Pasir Gogok	NM		0.032	NA
	EURO 5 MOGAS Pollutant: NMVOC 8 hrs Average Limit: NA	Tg. Pengelih	NM	0.201 (Bukit Penerang)	0.006	NA
		Pengelih Naval Base	NM		0.201	NA
		Kg. Penerang	NM		0.009	NA
		Kg. Sg. Kapal	NM		0.028	NA
		Taman Rengit Jaya	NM		0.022	NA
		Kg. Sg. Buntu	NM		0.017	NA
		Kg. Bukit Buloh	NM		0.008	NA
		Kg. Sg. Rengit	NM		0.007	NA
		Kg. Bukit Gelugor	NM		0.006	NA
		Kg. Lepau	NM		0.010	NA
		Kg. Pasir Gogok	NM		0.004	NA
	EURO 5 MOGAS Pollutant: NMVOC 24 hrs Average Limit: NA	Tg. Pengelih	NM	0.067 (Bukit Penerang)	0.002	NA
		Pengelih Naval Base	NM		0.067	NA
		Kg. Penerang	NM		0.004	NA
		Kg. Sg. Kapal	NM		0.013	NA



CHAPTER 4
POTENTIAL ENVIRONMENTAL IMPACT AND MITIGATION MEASURES

No	Scenario	Receptor	Baseline (Oct 2012)	Normal Operating Scenario		
				Max Incremental ($\mu\text{g}/\text{m}^3$)	Receptor Incremental ($\mu\text{g}/\text{m}^3$)	Cumulative GLC ($\mu\text{g}/\text{m}^3$)
		Taman Rengit Jaya	NM		0.010	NA
		Kg. Sg. Buntu	NM		0.008	NA
		Kg. Bukit Buloh	NM		0.003	NA
		Kg. Sg. Rengit	NM		0.003	NA
		Kg. Bukit Gelugor	NM		0.003	NA
		Kg. Lepau	NM		0.003	NA
		Kg. Pasir Gogok	NM		0.002	NA



Table 4-13 Predicted Incremental GLC and Cumulative GLC for Refinery Cracker Complex (Normal Operation)

No	Scenario	Receptor	Baseline (Oct 2012)	Normal Operating Scenario		
				Max Incremental ($\mu\text{g}/\text{m}^3$)	Receptor Incremental ($\mu\text{g}/\text{m}^3$)	Cumulative GLC ($\mu\text{g}/\text{m}^3$)
	Refinery Cracker Complex Pollutant: PM₁₀ 24 hrs Average Limit: 100 $\mu\text{g}/\text{m}^3$	Tg. Pengelih	24	1.8 (Bukit Pengerang)	0.191	24.2
		Pengelih Naval Base	24		0.383	24.4
		Kg. Pengerang	36		0.217	36.2
		Kg. Sg. Kapal	25		0.389	25.4
		Taman Rengit Jaya	38		0.391	38.4
		Kg. Sg. Buntu	28		0.368	28.4
		Kg. Bukit Buloh	31		0.396	31.4
		Kg. Sg. Rengit	20		0.280	20.3
		Kg. Bukit Gelugor	22		0.237	22.2
		Kg. Lepau	35		0.441	35.4
		Kg. Pasir Gogok	20		0.262	20.3
	Refinery Cracker Complex Pollutant: PM₁₀ Annual Average Limit: 40 $\mu\text{g}/\text{m}^3$	Tg. Pengelih	NM	0.295 (Within RAPID)	0.012	NA
		Pengelih Naval Base	NM		0.020	NA
		Kg. Pengerang	NM		0.017	NA
		Kg. Sg. Kapal	NM		0.053	NA
		Taman Rengit Jaya	NM		0.048	NA
		Kg. Sg. Buntu	NM		0.037	NA
		Kg. Bukit Buloh	NM		0.038	NA
		Kg. Sg. Rengit	NM		0.027	NA
		Kg. Bukit Gelugor	NM		0.023	NA
		Kg. Lepau	NM		0.079	NA
		Kg. Pasir Gogok	NM		0.016	NA



CHAPTER 4
POTENTIAL ENVIRONMENTAL IMPACT AND MITIGATION MEASURES

No	Scenario	Receptor	Baseline (Oct 2012)	Normal Operating Scenario		
				Max Incremental ($\mu\text{g}/\text{m}^3$)	Receptor Incremental ($\mu\text{g}/\text{m}^3$)	Cumulative GLC ($\mu\text{g}/\text{m}^3$)
	Refinery Cracker Complex Pollutant: $\text{PM}_{2.5}$ 24 hrs Average Limit: $35 \mu\text{g}/\text{m}^3$	Tg. Pengelih	NM	1.6 (Bukit Pengerang)	0.135	NA
		Pengelih Naval Base	NM		0.344	NA
		Kg. Pengerang	NM		0.158	NA
		Kg. Sg. Kapal	NM		0.256	NA
		Taman Rengit Jaya	NM		0.265	NA
		Kg. Sg. Buntu	NM		0.241	NA
		Kg. Bukit Buloh	NM		0.245	NA
		Kg. Sg. Rengit	NM		0.178	NA
		Kg. Bukit Gelugor	NM		0.151	NA
		Kg. Lepau	NM		0.341	NA
		Kg. Pasir Gogok	NM		0.159	NA
	Refinery Cracker Complex Pollutant: $\text{PM}_{2.5}$ Annual Average Limit: $15 \mu\text{g}/\text{m}^3$	Tg. Pengelih	NM	0.214 (Within RAPID)	0.008	NA
		Pengelih Naval Base	NM		0.015	NA
		Kg. Pengerang	NM		0.011	NA
		Kg. Sg. Kapal	NM		0.032	NA
		Taman Rengit Jaya	NM		0.029	NA
		Kg. Sg. Buntu	NM		0.023	NA
		Kg. Bukit Buloh	NM		0.023	NA
		Kg. Sg. Rengit	NM		0.016	NA
		Kg. Bukit Gelugor	NM		0.014	NA
		Kg. Lepau	NM		0.056	NA
		Kg. Pasir Gogok	NM		0.011	NA
	Refinery Cracker Complex	Tg. Pengelih	<5	791.5 (Bukit Pelali)	67.2	72.2
		Pengelih Naval Base	<5		198.7	203.7



CHAPTER 4
POTENTIAL ENVIRONMENTAL IMPACT AND MITIGATION MEASURES

No	Scenario	Receptor	Baseline (Oct 2012)	Normal Operating Scenario		
				Max Incremental ($\mu\text{g}/\text{m}^3$)	Receptor Incremental ($\mu\text{g}/\text{m}^3$)	Cumulative GLC ($\mu\text{g}/\text{m}^3$)
	Pollutant: NO₂ Tier1 1 hr Average Limit: 280 $\mu\text{g}/\text{m}^3$	Kg. Pengerang	<5		86.1	91.1
		Kg. Sg. Kapal	<5		165.0	170.0
		Taman Rengit Jaya	<5		123.9	128.9
		Kg. Sg. Buntu	<5		91.5	96.5
		Kg. Bukit Buloh	<5		163.8	168.8
		Kg. Sg. Rengit	ND		121.4	121.4
		Kg. Bukit Gelugor	<5		113.0	118.0
		Kg. Lepau	<5		146.2	151.2
		Kg. Pasir Gogok	ND		79.0	79.0
	Refinery Cracker Complex Pollutant: NO₂ Tier1 24 hrs Average Limit: 70 $\mu\text{g}/\text{m}^3$	Tg. Pengelih	NM	98.2 (Bukit Pengerang)	8.7	NA
		Pengelih Naval Base	NM		28.1	NA
		Kg. Pengerang	NM		10.3	NA
		Kg. Sg. Kapal	NM		19.7	NA
		Taman Rengit Jaya	NM		19.6	NA
		Kg. Sg. Buntu	NM		17.0	NA
		Kg. Bukit Buloh	NM		13.8	NA
		Kg. Sg. Rengit	NM		9.5	NA
		Kg. Bukit Gelugor	NM		9.9	NA
		Kg. Lepau	NM		16.0	NA
		Kg. Pasir Gogok	NM		9.5	NA
	Refinery Cracker Complex Pollutant: NO₂ Tier3	Tg. Pengelih	<5	483.1 (Bukit Pelali)	14.2	19.2
		Pengelih Naval Base	<5		122.1	127.1
		Kg. Pengerang	<5		20.4	25.4
		Kg. Sg. Kapal	<5		78.8	83.8



CHAPTER 4
POTENTIAL ENVIRONMENTAL IMPACT AND MITIGATION MEASURES

No	Scenario	Receptor	Baseline (Oct 2012)	Normal Operating Scenario		
				Max Incremental ($\mu\text{g}/\text{m}^3$)	Receptor Incremental ($\mu\text{g}/\text{m}^3$)	Cumulative GLC ($\mu\text{g}/\text{m}^3$)
	1 hr Average Limit: $280 \mu\text{g}/\text{m}^3$	Taman Rengit Jaya	<5		70.7	75.7
		Kg. Sg. Buntu	<5		62.7	67.7
		Kg. Bukit Buloh	<5		92.1	97.1
		Kg. Sg. Rengit	ND		68.5	68.5
		Kg. Bukit Gelugor	<5		63.9	68.9
		Kg. Lepau	<5		68.1	73.1
		Kg. Pasir Gogok	ND		32.0	32.0
	Refinery Cracker Complex Pollutant: NO₂ 99.6 Percentile 1 hr Average Limit: $280 \mu\text{g}/\text{m}^3$	Tg. Pengelih	<5	254.5 (Bukit Pelali)	12.3	17.3
		Pengelih Naval Base	<5		30.3	35.3
		Kg. Pengerang	<5		17.3	22.3
		Kg. Sg. Kapal	<5		56.2	61.2
		Taman Rengit Jaya	<5		52.8	57.8
		Kg. Sg. Buntu	<5		45.3	50.3
		Kg. Bukit Buloh	<5		60.5	65.5
		Kg. Sg. Rengit	ND		48.3	48.3
		Kg. Bukit Gelugor	<5		36.1	41.1
		Kg. Lepau	<5		50.8	55.8
Kg. Pasir Gogok	ND	16.3	16.3			
	Refinery Cracker Complex Pollutant: NO₂ 99.8 Percentile 24 hrs Average Limit: $70 \mu\text{g}/\text{m}^3$	Tg. Pengelih	NM	63.9 (Bukit Pelali)	3.6	NA
		Pengelih Naval Base	NM		21.7	NA
		Kg. Pengerang	NM		4.6	NA
		Kg. Sg. Kapal	NM		16.0	NA
		Taman Rengit Jaya	NM		14.8	NA
		Kg. Sg. Buntu	NM		12.2	NA



CHAPTER 4
POTENTIAL ENVIRONMENTAL IMPACT AND MITIGATION MEASURES

No	Scenario	Receptor	Baseline (Oct 2012)	Normal Operating Scenario		
				Max Incremental ($\mu\text{g}/\text{m}^3$)	Receptor Incremental ($\mu\text{g}/\text{m}^3$)	Cumulative GLC ($\mu\text{g}/\text{m}^3$)
		Kg. Bukit Buloh	NM		11.4	NA
		Kg. Sg. Rengit	NM		8.7	NA
		Kg. Bukit Gelugor	NM		7.6	NA
		Kg. Lepau	NM		15.5	NA
		Kg. Pasir Gogok	NM		7.8	NA
	Refinery Cracker Complex Pollutant: SO_2 1 hr Average Limit: $250 \mu\text{g}/\text{m}^3$	Tg. Pengelih	<5	95.6 (Within RAPID)	18.8	23.8
		Pengelih Naval Base	<5		30.2	35.2
		Kg. Pengerang	<5		20.2	25.2
		Kg. Sg. Kapal	<5		52.7	57.7
		Taman Rengit Jaya	<5		37.4	42.4
		Kg. Sg. Buntu	<5		29.1	34.1
		Kg. Bukit Buloh	<5		51.2	56.2
		Kg. Sg. Rengit	ND		36.9	36.9
		Kg. Bukit Gelugor	<5		33.4	38.4
		Kg. Lepau	<5		51.5	56.5
		Kg. Pasir Gogok	ND		23.9	23.9
	Refinery Cracker Complex Pollutant: SO_2 24 hrs Average Limit: $80 \mu\text{g}/\text{m}^3$	Tg. Pengelih	NM	18.0 (Within RAPID)	2.2	NA
		Pengelih Naval Base	NM		4.5	NA
		Kg. Pengerang	NM		2.2	NA
		Kg. Sg. Kapal	NM		5.0	NA
		Taman Rengit Jaya	NM		4.8	NA
		Kg. Sg. Buntu	NM		4.2	NA
		Kg. Bukit Buloh	NM		4.1	NA
		Kg. Sg. Rengit	NM		2.9	NA



CHAPTER 4
POTENTIAL ENVIRONMENTAL IMPACT AND MITIGATION MEASURES

No	Scenario	Receptor	Baseline (Oct 2012)	Normal Operating Scenario		
				Max Incremental ($\mu\text{g}/\text{m}^3$)	Receptor Incremental ($\mu\text{g}/\text{m}^3$)	Cumulative GLC ($\mu\text{g}/\text{m}^3$)
		Kg. Bukit Gelugor	NM		2.7	NA
		Kg. Lepau	NM		5.7	NA
		Kg. Pasir Gogok	NM		3.3	NA
	Refinery Cracker Complex Pollutant: CO 1 hr Average Limit: 30,000 $\mu\text{g}/\text{m}^3$	Tg. Pengelih	NM	455.4 (Eastern side of RAPID)	31.4	NA
		Pengelih Naval Base	NM		74.6	NA
		Kg. Pengerang	NM		34.1	NA
		Kg. Sg. Kapal	NM		87.3	NA
		Taman Rengit Jaya	NM		77.8	NA
		Kg. Sg. Buntu	NM		44.1	NA
		Kg. Bukit Buloh	NM		455.4	NA
		Kg. Sg. Rengit	NM		54.8	NA
		Kg. Bukit Gelugor	NM		50.8	NA
		Kg. Lepau	NM		72.7	NA
		Kg. Pasir Gogok	NM	37.6	NA	
	Refinery Cracker Complex Pollutant: CO 8 hrs Average Limit: 10,000 $\mu\text{g}/\text{m}^3$	Tg. Pengelih	<100	204.8 (Within RAPID)	9.6	109.6
		Pengelih Naval Base	<100		26.5	126.5
		Kg. Pengerang	<100		8.5	108.5
		Kg. Sg. Kapal	<100		21.5	121.5
		Taman Rengit Jaya	<100		41.5	141.5
		Kg. Sg. Buntu	<100		20.6	120.6
		Kg. Bukit Buloh	<100		204.8	304.8
		Kg. Sg. Rengit	ND		11.5	11.5
		Kg. Bukit Gelugor	<100		9.9	109.9
		Kg. Lepau	<100		22.4	122.4



CHAPTER 4
POTENTIAL ENVIRONMENTAL IMPACT AND MITIGATION MEASURES

No	Scenario	Receptor	Baseline (Oct 2012)	Normal Operating Scenario		
				Max Incremental ($\mu\text{g}/\text{m}^3$)	Receptor Incremental ($\mu\text{g}/\text{m}^3$)	Cumulative GLC ($\mu\text{g}/\text{m}^3$)
		Kg. Pasir Gogok	ND		10.6	10.6
Refinery Cracker Complex Pollutant: NH_3 1 hr Average Limit: NA		Tg. Pengelih	NM	1.6 Within RAPID	0.088	NA
		Pengelih Naval Base	NM		0.036	NA
		Kg. Penerang	NM		0.099	NA
		Kg. Sg. Kapal	NM		0.189	NA
		Taman Rengit Jaya	NM		0.311	NA
		Kg. Sg. Buntu	NM		0.138	NA
		Kg. Bukit Buloh	NM		1.036	NA
		Kg. Sg. Rengit	NM		0.103	NA
		Kg. Bukit Gelugor	NM		0.091	NA
		Kg. Lepau	NM		0.130	NA
		Kg. Pasir Gogok	NM		0.067	NA
Refinery Cracker Complex Pollutant: NH_3 8 hrs Average Limit: NA		Tg. Pengelih	NM	0.828 Within RAPID	0.023	NA
		Pengelih Naval Base	NM		0.005	NA
		Kg. Penerang	NM		0.025	NA
		Kg. Sg. Kapal	NM		0.066	NA
		Taman Rengit Jaya	NM		0.141	NA
		Kg. Sg. Buntu	NM		0.056	NA
		Kg. Bukit Buloh	NM		0.535	NA
		Kg. Sg. Rengit	NM		0.017	NA
		Kg. Bukit Gelugor	NM		0.019	NA
		Kg. Lepau	NM		0.025	NA
		Kg. Pasir Gogok	NM		0.024	NA



CHAPTER 4
POTENTIAL ENVIRONMENTAL IMPACT AND MITIGATION MEASURES

No	Scenario	Receptor	Baseline (Oct 2012)	Normal Operating Scenario		
				Max Incremental ($\mu\text{g}/\text{m}^3$)	Receptor Incremental ($\mu\text{g}/\text{m}^3$)	Cumulative GLC ($\mu\text{g}/\text{m}^3$)
	Refinery Cracker Complex Pollutant: NH₃ 24 hrs Average Limit: NA	Tg. Pengelih	NM	0.302 Within RAPID	0.008	NA
		Pengelih Naval Base	NM		0.002	NA
		Kg. Pengerang	NM		0.011	NA
		Kg. Sg. Kapal	NM		0.027	NA
		Taman Rengit Jaya	NM		0.043	NA
		Kg. Sg. Buntu	NM		0.020	NA
		Kg. Bukit Buloh	NM		0.188	NA
		Kg. Sg. Rengit	NM		0.006	NA
		Kg. Bukit Gelugor	NM		0.006	NA
		Kg. Lepau	NM		0.008	NA
		Kg. Pasir Gogok	NM		0.008	NA
	Refinery Cracker Complex Pollutant: Methanol 1 hr Average Limit: NA	Tg. Pengelih	NM	33.3 (Within RAPID)	1.804	NA
		Pengelih Naval Base	NM		0.740	NA
		Kg. Pengerang	NM		2.030	NA
		Kg. Sg. Kapal	NM		3.850	NA
		Taman Rengit Jaya	NM		6.337	NA
		Kg. Sg. Buntu	NM		2.812	NA
		Kg. Bukit Buloh	NM		21.148	NA
		Kg. Sg. Rengit	NM		2.103	NA
		Kg. Bukit Gelugor	NM		1.855	NA
		Kg. Lepau	NM		2.645	NA
		Kg. Pasir Gogok	NM		1.359	NA
	Refinery Cracker	Tg. Pengelih	NM	16.9	0.476	NA



CHAPTER 4
POTENTIAL ENVIRONMENTAL IMPACT AND MITIGATION MEASURES

No	Scenario	Receptor	Baseline (Oct 2012)	Normal Operating Scenario		
				Max Incremental ($\mu\text{g}/\text{m}^3$)	Receptor Incremental ($\mu\text{g}/\text{m}^3$)	Cumulative GLC ($\mu\text{g}/\text{m}^3$)
	Complex Pollutant: Methanol 8 hrs Average Limit: NA	Pengelih Naval Base	NM	(Within RAPID)	0.100	NA
		Kg. Pengerang	NM		0.507	NA
		Kg. Sg. Kapal	NM		1.344	NA
		Taman Rengit Jaya	NM		2.887	NA
		Kg. Sg. Buntu	NM		1.135	NA
		Kg. Bukit Buloh	NM		10.917	NA
		Kg. Sg. Rengit	NM		0.349	NA
		Kg. Bukit Gelugor	NM		0.394	NA
		Kg. Lepau	NM		0.510	NA
		Kg. Pasir Gogok	NM		0.498	NA
	Refinery Cracker Complex Pollutant: Methanol 24 hrs Average Limit: NA	Tg. Pengelih	NM	6.2 (Within RAPID)	0.159	NA
		Pengelih Naval Base	NM		0.033	NA
		Kg. Pengerang	NM		0.229	NA
		Kg. Sg. Kapal	NM		0.552	NA
		Taman Rengit Jaya	NM		0.885	NA
		Kg. Sg. Buntu	NM		0.406	NA
		Kg. Bukit Buloh	NM		3.836	NA
		Kg. Sg. Rengit	NM		0.117	NA
		Kg. Bukit Gelugor	NM		0.132	NA
		Kg. Lepau	NM		0.170	NA
Kg. Pasir Gogok	NM	0.166	NA			
	Refinery Cracker Complex Pollutant: NM VOC	Tg. Pengelih	NM	42.2 (Bukit Pelali)	1.087	NA
		Pengelih Naval Base	NM		15.255	NA
		Kg. Pengerang	NM		1.964	NA



CHAPTER 4
POTENTIAL ENVIRONMENTAL IMPACT AND MITIGATION MEASURES

No	Scenario	Receptor	Baseline (Oct 2012)	Normal Operating Scenario		
				Max Incremental ($\mu\text{g}/\text{m}^3$)	Receptor Incremental ($\mu\text{g}/\text{m}^3$)	Cumulative GLC ($\mu\text{g}/\text{m}^3$)
	1 hr Average Limit: NA	Kg. Sg. Kapal	NM		1.967	NA
		Taman Rengit Jaya	NM		2.051	NA
		Kg. Sg. Buntu	NM		1.885	NA
		Kg. Bukit Buloh	NM		2.219	NA
		Kg. Sg. Rengit	NM		2.084	NA
		Kg. Bukit Gelugor	NM		1.865	NA
		Kg. Lepau	NM		1.853	NA
		Kg. Pasir Gogok	NM		1.714	NA
	Refinery Cracker Complex Pollutant: NMVOC 8 hrs Average Limit: NA	Tg. Pengelih	NM	9.6 (Bukit Pengerang)	0.228	NA
		Pengelih Naval Base	NM		6.060	NA
		Kg. Pengerang	NM		0.265	NA
		Kg. Sg. Kapal	NM		0.866	NA
		Taman Rengit Jaya	NM		0.794	NA
		Kg. Sg. Buntu	NM		0.658	NA
		Kg. Bukit Buloh	NM		0.444	NA
		Kg. Sg. Rengit	NM		0.364	NA
		Kg. Bukit Gelugor	NM		0.379	NA
		Kg. Lepau	NM		0.516	NA
		Kg. Pasir Gogok	NM		0.305	NA
	Refinery Cracker Complex Pollutant: NMVOC 24 hrs Average Limit: NA	Tg. Pengelih	NM	3.2 (Bukit Pelali)	0.136	NA
		Pengelih Naval Base	NM		2.033	NA
		Kg. Pengerang	NM		0.184	NA
		Kg. Sg. Kapal	NM		0.471	NA
		Taman Rengit Jaya	NM		0.464	NA



CHAPTER 4
POTENTIAL ENVIRONMENTAL IMPACT AND MITIGATION MEASURES

No	Scenario	Receptor	Baseline (Oct 2012)	Normal Operating Scenario		
				Max Incremental ($\mu\text{g}/\text{m}^3$)	Receptor Incremental ($\mu\text{g}/\text{m}^3$)	Cumulative GLC ($\mu\text{g}/\text{m}^3$)
		Kg. Sg. Buntu	NM		0.360	NA
		Kg. Bukit Buloh	NM		0.188	NA
		Kg. Sg. Rengit	NM		0.149	NA
		Kg. Bukit Gelugor	NM		0.142	NA
		Kg. Lepau	NM		0.206	NA
		Kg. Pasir Gogok	NM		0.115	NA
	Refinery Cracker Complex Pollutant: H₂S 1 hr Average Limit: NA	Tg. Pengelih	NM	4.2 (Within RAPID)	1.240	NA
		Pengelih Naval Base	NM		0.791	NA
		Kg. Penerang	NM		1.007	NA
		Kg. Sg. Kapal	NM		1.430	NA
		Taman Rengit Jaya	NM		1.266	NA
		Kg. Sg. Buntu	NM		1.312	NA
		Kg. Bukit Buloh	NM		1.711	NA
		Kg. Sg. Rengit	NM		1.281	NA
		Kg. Bukit Gelugor	NM		1.307	NA
		Kg. Lepau	NM		2.351	NA
	Kg. Pasir Gogok	NM	0.972	NA		
	Refinery Cracker Complex Pollutant: H₂S 8 hrs Average Limit: NA	Tg. Pengelih	NM	2.4 (Within RAPID)	0.155	NA
		Pengelih Naval Base	NM		0.165	NA
		Kg. Penerang	NM		0.134	NA
		Kg. Sg. Kapal	NM		0.428	NA
		Taman Rengit Jaya	NM		0.367	NA
		Kg. Sg. Buntu	NM		0.339	NA
		Kg. Bukit Buloh	NM		0.384	NA



CHAPTER 4
POTENTIAL ENVIRONMENTAL IMPACT AND MITIGATION MEASURES

No	Scenario	Receptor	Baseline (Oct 2012)	Normal Operating Scenario		
				Max Incremental ($\mu\text{g}/\text{m}^3$)	Receptor Incremental ($\mu\text{g}/\text{m}^3$)	Cumulative GLC ($\mu\text{g}/\text{m}^3$)
		Kg. Sg. Rengit	NM		0.302	NA
		Kg. Bukit Gelugor	NM		0.216	NA
		Kg. Lepau	NM		0.625	NA
		Kg. Pasir Gogok	NM		0.243	NA
	Refinery Cracker Complex Pollutant: H₂S 24 hrs Average Limit: NA	Tg. Pengelih	NM	0.907 (Within RAPID)	0.096	NA
		Pengelih Naval Base	NM		0.094	NA
		Kg. Pengerang	NM		0.087	NA
		Kg. Sg. Kapal	NM		0.170	NA
		Taman Rengit Jaya	NM		0.145	NA
		Kg. Sg. Buntu	NM		0.136	NA
		Kg. Bukit Buloh	NM		0.153	NA
		Kg. Sg. Rengit	NM		0.120	NA
		Kg. Bukit Gelugor	NM		0.110	NA
		Kg. Lepau	NM		0.253	NA
		Kg. Pasir Gogok	NM		0.083	NA

Note:

All concentration unit in $\mu\text{g}/\text{m}^3$

NM = Not monitored

NA = Not Available



Table 4-14 Predicted Incremental GLC and Cumulative GLC for Cumulative RAPID Complex (Normal Operation)

No	Scenario	Receptor	Baseline (Oct 2012)	Normal Operating Scenario		
				Max Incremental ($\mu\text{g}/\text{m}^3$)	Receptor Incremental ($\mu\text{g}/\text{m}^3$)	Cumulative GLC ($\mu\text{g}/\text{m}^3$)
	Cumulative RAPID Complex Pollutant: PM₁₀ 24 hrs Average Limit: 100 $\mu\text{g}/\text{m}^3$	Tg. Pengelih	24	3.3 (Bukit Pengerang)	0.339	24.3
		Pengelih Naval Base	24		2.5	26.5
		Kg. Pengerang	36		0.467	36.5
		Kg. Sg. Kapal	25		0.544	25.5
		Taman Rengit Jaya	38		0.531	38.5
		Kg. Sg. Buntu	28		0.476	28.5
		Kg. Bukit Buloh	31		0.513	31.5
		Kg. Sg. Rengit	20		0.428	20.4
		Kg. Bukit Gelugor	22		0.361	22.4
		Kg. Lepau	35		0.666	35.7
		Kg. Pasir Gokok	20		0.381	20.4
	Cumulative RAPID Complex Pollutant: PM₁₀ Annual Average Limit: 40 $\mu\text{g}/\text{m}^3$	Tg. Pengelih	NM	0.496 (Within RAPID)	0.023	NA
		Pengelih Naval Base	NM		0.080	NA
		Kg. Pengerang	NM		0.032	NA
		Kg. Sg. Kapal	NM		0.081	NA
		Taman Rengit Jaya	NM		0.077	NA
		Kg. Sg. Buntu	NM		0.064	NA
		Kg. Bukit Buloh	NM		0.063	NA
		Kg. Sg. Rengit	NM		0.047	NA
		Kg. Bukit Gelugor	NM		0.042	NA
		Kg. Lepau	NM		0.126	NA
		Kg. Pasir Gokok	NM		0.031	NA



ADDITIONAL INFORMATION TO THE DEIA REFINERY AND PETROCHEMICAL INTEGRATED DEVELOPMENT (RAPID) PROJECT, PENGERANG JOHOR, 2012 TO INCLUDE EURO 5 MOGAS AND OLEFIN TANK UNITS



CHAPTER 4
POTENTIAL ENVIRONMENTAL IMPACT AND MITIGATION MEASURES

No	Scenario	Receptor	Baseline (Oct 2012)	Normal Operating Scenario		
				Max Incremental ($\mu\text{g}/\text{m}^3$)	Receptor Incremental ($\mu\text{g}/\text{m}^3$)	Cumulative GLC ($\mu\text{g}/\text{m}^3$)
	Cumulative RAPID Complex Pollutant: $\text{PM}_{2.5}$ 24 hrs Average Limit: $35 \mu\text{g}/\text{m}^3$	Tg. Pengelih	NM	2.5 (Bukit Pengerang)	0.244	NA
		Pengelih Naval Base	NM		1.6	NA
		Kg. Pengerang	NM		0.321	NA
		Kg. Sg. Kapal	NM		0.361	NA
		Taman Rengit Jaya	NM		0.361	NA
		Kg. Sg. Buntu	NM		0.314	NA
		Kg. Bukit Buloh	NM		0.339	NA
		Kg. Sg. Rengit	NM		0.296	NA
		Kg. Bukit Gelugor	NM		0.253	NA
		Kg. Lepau	NM		0.491	NA
		Kg. Pasir Gogok	NM		0.267	NA
	Cumulative RAPID Complex Pollutant: $\text{PM}_{2.5}$ Annual Average Limit: $15 \mu\text{g}/\text{m}^3$	Tg. Pengelih	NM	0.331 (Within RAPID)	0.017	NA
		Pengelih Naval Base	NM		0.052	NA
		Kg. Pengerang	NM		0.023	NA
		Kg. Sg. Kapal	NM		0.054	NA
		Taman Rengit Jaya	NM		0.052	NA
		Kg. Sg. Buntu	NM		0.045	NA
		Kg. Bukit Buloh	NM		0.044	NA
		Kg. Sg. Rengit	NM		0.034	NA
		Kg. Bukit Gelugor	NM		0.031	NA
		Kg. Lepau	NM		0.090	NA
		Kg. Pasir Gogok	NM		0.023	NA
	Cumulative RAPID Complex	Tg. Pengelih	<5	808.3 (Bukit Pelali)	81.0	86.0
		Pengelih Naval Base	<5		281.4	286.4



CHAPTER 4
POTENTIAL ENVIRONMENTAL IMPACT AND MITIGATION MEASURES

No	Scenario	Receptor	Baseline (Oct 2012)	Normal Operating Scenario		
				Max Incremental ($\mu\text{g}/\text{m}^3$)	Receptor Incremental ($\mu\text{g}/\text{m}^3$)	Cumulative GLC ($\mu\text{g}/\text{m}^3$)
	Pollutant: NO₂ Tier1 1 hr Average Limit: 280 $\mu\text{g}/\text{m}^3$	Kg. Pengerang	<5		103.0	108.0
		Kg. Sg. Kapal	<5		181.5	186.5
		Taman Rengit Jaya	<5		141.0	146.0
		Kg. Sg. Buntu	<5		99.9	104.9
		Kg. Bukit Buloh	<5		175.6	180.6
		Kg. Sg. Rengit	ND		133.3	133.3
		Kg. Bukit Gelugor	<5		127.8	132.8
		Kg. Lepau	<5		161.9	166.9
		Kg. Pasir Gogok	ND		92.2	92.2
	Cumulative RAPID Complex Pollutant: NO₂ Tier1 24 hrs Average Limit: 70 $\mu\text{g}/\text{m}^3$	Tg. Pengelih	NM	115.5 (Bukit Pengerang)	10.9	NA
		Pengelih Naval Base	NM		41.8	NA
		Kg. Pengerang	NM		13.2	NA
		Kg. Sg. Kapal	NM		21.4	NA
		Taman Rengit Jaya	NM		21.2	NA
		Kg. Sg. Buntu	NM		18.9	NA
		Kg. Bukit Buloh	NM		16.1	NA
		Kg. Sg. Rengit	NM		12.1	NA
		Kg. Bukit Gelugor	NM		12.2	NA
		Kg. Lepau	NM		18.5	NA
		Kg. Pasir Gogok	NM		12.1	NA
	Cumulative RAPID Complex Pollutant: NO₂ Tier3 1 hr Average	Tg. Pengelih	<5	526.9 (Bukit Pelali)	18.5	23.5
		Pengelih Naval Base	<5		178.9	183.9
		Kg. Pengerang	<5		24.8	29.8
		Kg. Sg. Kapal	<5		86.5	91.5



CHAPTER 4
POTENTIAL ENVIRONMENTAL IMPACT AND MITIGATION MEASURES

No	Scenario	Receptor	Baseline (Oct 2012)	Normal Operating Scenario		
				Max Incremental ($\mu\text{g}/\text{m}^3$)	Receptor Incremental ($\mu\text{g}/\text{m}^3$)	Cumulative GLC ($\mu\text{g}/\text{m}^3$)
	Limit: $280 \mu\text{g}/\text{m}^3$	Taman Rengit Jaya	<5		77.5	82.5
		Kg. Sg. Buntu	<5		71.4	76.4
		Kg. Bukit Buloh	<5		100.5	105.5
		Kg. Sg. Rengit	ND		77.4	77.4
		Kg. Bukit Gelugor	<5		75.5	80.5
		Kg. Lepau	<5		73.0	78.0
		Kg. Pasir Gokok	ND		41.1	41.1
	Cumulative RAPID Complex Pollutant: NO₂ 99.5 Percentile 1 hr Average Limit: $280 \mu\text{g}/\text{m}^3$	Tg. Pengelih	<5	256.0 (Bukit Pelali)	16.0	21.0
		Pengelih Naval Base	<5		48.7	53.7
		Kg. Pengerang	<5		22.1	27.1
		Kg. Sg. Kapal	<5		57.3	62.3
		Taman Rengit Jaya	<5		54.1	59.1
		Kg. Sg. Buntu	<5		46.6	51.6
		Kg. Bukit Buloh	<5		62.1	67.1
		Kg. Sg. Rengit	ND		53.2	53.2
		Kg. Bukit Gelugor	<5		41.1	46.1
		Kg. Lepau	<5		56.2	61.2
		Kg. Pasir Gokok	ND		20.4	20.4
	Cumulative RAPID Complex Pollutant: NO₂ 99.7 Percentile 24 hrs Average Limit: $70 \mu\text{g}/\text{m}^3$	Tg. Pengelih	NM	66.9 (Bukit Pelali)	4.4	NA
		Pengelih Naval Base	NM		25.9	NA
		Kg. Pengerang	NM		5.9	NA
		Kg. Sg. Kapal	NM		16.0	NA
		Taman Rengit Jaya	NM		15.2	NA
		Kg. Sg. Buntu	NM		13.7	NA



CHAPTER 4
POTENTIAL ENVIRONMENTAL IMPACT AND MITIGATION MEASURES

No	Scenario	Receptor	Baseline (Oct 2012)	Normal Operating Scenario		
				Max Incremental ($\mu\text{g}/\text{m}^3$)	Receptor Incremental ($\mu\text{g}/\text{m}^3$)	Cumulative GLC ($\mu\text{g}/\text{m}^3$)
		Kg. Bukit Buloh	NM		13.3	NA
		Kg. Sg. Rengit	NM		10.6	NA
		Kg. Bukit Gelugor	NM		9.4	NA
		Kg. Lepau	NM		17.1	NA
		Kg. Pasir Gogok	NM		9.9	NA
	Cumulative RAPID Complex Pollutant: SO_2 1 hr Average Limit: $250 \mu\text{g}/\text{m}^3$	Tg. Pengelih	<5	91.0 (Within RAPID)	19.3	24.3
		Pengelih Naval Base	<5		30.3	35.3
		Kg. Pengerang	<5		20.7	25.7
		Kg. Sg. Kapal	<5		53.6	58.6
		Taman Rengit Jaya	<5		38.0	43.0
		Kg. Sg. Buntu	<5		29.4	34.4
		Kg. Bukit Buloh	<5		51.9	56.9
		Kg. Sg. Rengit	ND		37.4	37.4
		Kg. Bukit Gelugor	<5		33.9	38.9
		Kg. Lepau	<5		51.8	56.8
		Kg. Pasir Gogok	ND		24.4	24.4
	Cumulative RAPID Complex Pollutant: SO_2 24 hrs Average Limit: $80 \mu\text{g}/\text{m}^3$	Tg. Pengelih	NM	16.6 (Within RAPID)	2.2	NA
		Pengelih Naval Base	NM		4.6	NA
		Kg. Pengerang	NM		2.3	NA
		Kg. Sg. Kapal	NM		5.1	NA
		Taman Rengit Jaya	NM		4.9	NA
		Kg. Sg. Buntu	NM		4.3	NA
		Kg. Bukit Buloh	NM		4.2	NA
		Kg. Sg. Rengit	NM		3.0	NA



CHAPTER 4
POTENTIAL ENVIRONMENTAL IMPACT AND MITIGATION MEASURES

No	Scenario	Receptor	Baseline (Oct 2012)	Normal Operating Scenario		
				Max Incremental ($\mu\text{g}/\text{m}^3$)	Receptor Incremental ($\mu\text{g}/\text{m}^3$)	Cumulative GLC ($\mu\text{g}/\text{m}^3$)
		Kg. Bukit Gelugor	NM		2.8	NA
		Kg. Lepau	NM		5.8	NA
		Kg. Pasir Gokok	NM		3.3	NA
	Cumulative RAPID Complex Pollutant: CO 1 hr Average Limit: 30,000 $\mu\text{g}/\text{m}^3$	Tg. Pengelih	NM	569.8 (Eastern side of RAPID)	50.1	NA
		Pengelih Naval Base	NM		569.8	NA
		Kg. Pengerang	NM		77.7	NA
		Kg. Sg. Kapal	NM		104.1	NA
		Taman Rengit Jaya	NM		85.3	NA
		Kg. Sg. Buntu	NM		64.5	NA
		Kg. Bukit Buloh	NM		455.4	NA
		Kg. Sg. Rengit	NM		87.7	NA
		Kg. Bukit Gelugor	NM		76.4	NA
		Kg. Lepau	NM		86.0	NA
		Kg. Pasir Gokok	NM	48.7	NA	
	Cumulative RAPID Complex Pollutant: CO 8 hrs Average Limit: 10,000 $\mu\text{g}/\text{m}^3$	Tg. Pengelih	<100	205.0 (Within RAPID)	12.8	112.8
		Pengelih Naval Base	<100		164.1	264.1
		Kg. Pengerang	<100		16.8	116.8
		Kg. Sg. Kapal	<100		27.9	127.9
		Taman Rengit Jaya	<100		41.5	141.5
		Kg. Sg. Buntu	<100		21.5	121.5
		Kg. Bukit Buloh	<100		205.0	305.0
		Kg. Sg. Rengit	ND		22.1	22.1
		Kg. Bukit Gelugor	<100		15.8	115.8
		Kg. Lepau	<100		27.1	127.1



CHAPTER 4
POTENTIAL ENVIRONMENTAL IMPACT AND MITIGATION MEASURES

No	Scenario	Receptor	Baseline (Oct 2012)	Normal Operating Scenario		
				Max Incremental ($\mu\text{g}/\text{m}^3$)	Receptor Incremental ($\mu\text{g}/\text{m}^3$)	Cumulative GLC ($\mu\text{g}/\text{m}^3$)
		Kg. Pasir Gogok	ND		17.7	17.7
Cumulative RAPID Complex Pollutant: NH_3 1 hr Average Limit: NA		Tg. Pengelih	NM	1.6 Within RAPID	0.088	NA
		Pengelih Naval Base	NM		0.036	NA
		Kg. Penerang	NM		0.099	NA
		Kg. Sg. Kapal	NM		0.189	NA
		Taman Rengit Jaya	NM		0.311	NA
		Kg. Sg. Buntu	NM		0.138	NA
		Kg. Bukit Buloh	NM		1.036	NA
		Kg. Sg. Rengit	NM		0.103	NA
		Kg. Bukit Gelugor	NM		0.091	NA
		Kg. Lepau	NM		0.130	NA
		Kg. Pasir Gogok	NM		0.067	NA
Cumulative RAPID Complex Pollutant: NH_3 8 hrs Average Limit: NA		Tg. Pengelih	NM	0.828 Within RAPID	0.023	NA
		Pengelih Naval Base	NM		0.005	NA
		Kg. Penerang	NM		0.025	NA
		Kg. Sg. Kapal	NM		0.066	NA
		Taman Rengit Jaya	NM		0.141	NA
		Kg. Sg. Buntu	NM		0.056	NA
		Kg. Bukit Buloh	NM		0.535	NA
		Kg. Sg. Rengit	NM		0.017	NA
		Kg. Bukit Gelugor	NM		0.019	NA
		Kg. Lepau	NM		0.025	NA
		Kg. Pasir Gogok	NM		0.024	NA



CHAPTER 4
POTENTIAL ENVIRONMENTAL IMPACT AND MITIGATION MEASURES

No	Scenario	Receptor	Baseline (Oct 2012)	Normal Operating Scenario		
				Max Incremental ($\mu\text{g}/\text{m}^3$)	Receptor Incremental ($\mu\text{g}/\text{m}^3$)	Cumulative GLC ($\mu\text{g}/\text{m}^3$)
	Cumulative RAPID Complex Pollutant: NH₃ 24 hrs Average Limit: NA	Tg. Pengelih	NM	0.302 Within RAPID	0.008	NA
		Pengelih Naval Base	NM		0.002	NA
		Kg. Pengerang	NM		0.011	NA
		Kg. Sg. Kapal	NM		0.027	NA
		Taman Rengit Jaya	NM		0.043	NA
		Kg. Sg. Buntu	NM		0.020	NA
		Kg. Bukit Buloh	NM		0.188	NA
		Kg. Sg. Rengit	NM		0.006	NA
		Kg. Bukit Gelugor	NM		0.006	NA
		Kg. Lepau	NM		0.008	NA
		Kg. Pasir Gogok	NM		0.008	NA
	Cumulative RAPID Complex Pollutant: Methanol 1 hr Average Limit: NA	Tg. Pengelih	NM	33.3 (Within RAPID)	1.804	NA
		Pengelih Naval Base	NM		0.740	NA
		Kg. Pengerang	NM		2.030	NA
		Kg. Sg. Kapal	NM		3.850	NA
		Taman Rengit Jaya	NM		6.337	NA
		Kg. Sg. Buntu	NM		2.812	NA
		Kg. Bukit Buloh	NM		21.148	NA
		Kg. Sg. Rengit	NM		2.103	NA
		Kg. Bukit Gelugor	NM		1.855	NA
		Kg. Lepau	NM		2.645	NA
		Kg. Pasir Gogok	NM		1.359	NA
Cumulative RAPID	Tg. Pengelih	NM	16.9	0.476	NA	



CHAPTER 4
POTENTIAL ENVIRONMENTAL IMPACT AND MITIGATION MEASURES

No	Scenario	Receptor	Baseline (Oct 2012)	Normal Operating Scenario		
				Max Incremental ($\mu\text{g}/\text{m}^3$)	Receptor Incremental ($\mu\text{g}/\text{m}^3$)	Cumulative GLC ($\mu\text{g}/\text{m}^3$)
	Complex Pollutant: Methanol 8 hrs Average Limit: NA	Pengelih Naval Base	NM	(Within RAPID)	0.100	NA
		Kg. Penerang	NM		0.507	NA
		Kg. Sg. Kapal	NM		1.344	NA
		Taman Rengit Jaya	NM		2.887	NA
		Kg. Sg. Buntu	NM		1.135	NA
		Kg. Bukit Buloh	NM		10.917	NA
		Kg. Sg. Rengit	NM		0.349	NA
		Kg. Bukit Gelugor	NM		0.394	NA
		Kg. Lepau	NM		0.510	NA
		Kg. Pasir Gogok	NM		0.498	NA
	Cumulative RAPID Complex Pollutant: Methanol 24 hrs Average Limit: NA	Tg. Pengelih	NM	6.2 (Within RAPID)	0.159	NA
		Pengelih Naval Base	NM		0.033	NA
		Kg. Penerang	NM		0.229	NA
		Kg. Sg. Kapal	NM		0.552	NA
		Taman Rengit Jaya	NM		0.885	NA
		Kg. Sg. Buntu	NM		0.406	NA
		Kg. Bukit Buloh	NM		3.836	NA
		Kg. Sg. Rengit	NM		0.117	NA
		Kg. Bukit Gelugor	NM		0.132	NA
		Kg. Lepau	NM		0.170	NA
Kg. Pasir Gogok	NM	0.166	NA			
	Cumulative RAPID Complex Pollutant: NM VOC	Tg. Pengelih	NM	42.2 (Bukit Pelali)	1.087	NA
		Pengelih Naval Base	NM		15.255	NA
		Kg. Penerang	NM		1.964	NA



CHAPTER 4
POTENTIAL ENVIRONMENTAL IMPACT AND MITIGATION MEASURES

No	Scenario	Receptor	Baseline (Oct 2012)	Normal Operating Scenario		
				Max Incremental ($\mu\text{g}/\text{m}^3$)	Receptor Incremental ($\mu\text{g}/\text{m}^3$)	Cumulative GLC ($\mu\text{g}/\text{m}^3$)
	1 hr Average Limit: NA	Kg. Sg. Kapal	NM		1.967	NA
		Taman Rengit Jaya	NM		2.051	NA
		Kg. Sg. Buntu	NM		1.885	NA
		Kg. Bukit Buloh	NM		2.219	NA
		Kg. Sg. Rengit	NM		2.084	NA
		Kg. Bukit Gelugor	NM		1.865	NA
		Kg. Lepau	NM		1.853	NA
		Kg. Pasir Gogok	NM		1.714	NA
	Cumulative RAPID Complex Pollutant: NMVOC 8 hrs Average Limit: NA	Tg. Pengelih	NM	9.6 (Bukit Pengerang)	0.228	NA
		Pengelih Naval Base	NM		6.060	NA
		Kg. Pengerang	NM		0.265	NA
		Kg. Sg. Kapal	NM		0.866	NA
		Taman Rengit Jaya	NM		0.794	NA
		Kg. Sg. Buntu	NM		0.658	NA
		Kg. Bukit Buloh	NM		0.444	NA
		Kg. Sg. Rengit	NM		0.364	NA
		Kg. Bukit Gelugor	NM		0.379	NA
		Kg. Lepau	NM		0.516	NA
		Kg. Pasir Gogok	NM		0.305	NA
			Cumulative RAPID Complex Pollutant: NMVOC 24 hrs Average Limit: NA		Tg. Pengelih	NM
Pengelih Naval Base	NM			2.033	NA	
Kg. Pengerang	NM			0.184	NA	
Kg. Sg. Kapal	NM			0.471	NA	
Taman Rengit Jaya	NM			0.464	NA	



CHAPTER 4
POTENTIAL ENVIRONMENTAL IMPACT AND MITIGATION MEASURES

No	Scenario	Receptor	Baseline (Oct 2012)	Normal Operating Scenario		
				Max Incremental ($\mu\text{g}/\text{m}^3$)	Receptor Incremental ($\mu\text{g}/\text{m}^3$)	Cumulative GLC ($\mu\text{g}/\text{m}^3$)
		Kg. Sg. Buntu	NM		0.360	NA
		Kg. Bukit Buloh	NM		0.188	NA
		Kg. Sg. Rengit	NM		0.149	NA
		Kg. Bukit Gelugor	NM		0.142	NA
		Kg. Lepau	NM		0.206	NA
		Kg. Pasir Gogok	NM		0.115	NA
	Cumulative RAPID Complex Pollutant: H₂S 1 hr Average Limit: NA	Tg. Pengelih	NM	4.2 (Within RAPID)	1.240	NA
		Pengelih Naval Base	NM		0.791	NA
		Kg. Pengerang	NM		1.007	NA
		Kg. Sg. Kapal	NM		1.430	NA
		Taman Rengit Jaya	NM		1.266	NA
		Kg. Sg. Buntu	NM		1.312	NA
		Kg. Bukit Buloh	NM		1.711	NA
		Kg. Sg. Rengit	NM		1.281	NA
		Kg. Bukit Gelugor	NM		1.307	NA
		Kg. Lepau	NM		2.351	NA
		Kg. Pasir Gogok	NM		0.972	NA
	Cumulative RAPID Complex Pollutant: H₂S 8 hrs Average Limit: NA	Tg. Pengelih	NM	2.4 (Within RAPID)	0.155	NA
		Pengelih Naval Base	NM		0.165	NA
		Kg. Pengerang	NM		0.134	NA
		Kg. Sg. Kapal	NM		0.428	NA
		Taman Rengit Jaya	NM		0.367	NA
		Kg. Sg. Buntu	NM		0.339	NA
		Kg. Bukit Buloh	NM		0.384	NA



CHAPTER 4
POTENTIAL ENVIRONMENTAL IMPACT AND MITIGATION MEASURES



No	Scenario	Receptor	Baseline (Oct 2012)	Normal Operating Scenario		
				Max Incremental ($\mu\text{g}/\text{m}^3$)	Receptor Incremental ($\mu\text{g}/\text{m}^3$)	Cumulative GLC ($\mu\text{g}/\text{m}^3$)
		Kg. Sg. Rengit	NM		0.302	NA
		Kg. Bukit Gelugor	NM		0.216	NA
		Kg. Lepau	NM		0.625	NA
		Kg. Pasir Gogok	NM		0.243	NA
	Cumulative RAPID Complex Pollutant: H₂S 24 hrs Average Limit: NA	Tg. Pengelih	NM	0.907 (Within RAPID)	0.096	NA
		Pengelih Naval Base	NM		0.094	NA
		Kg. Pengerang	NM		0.087	NA
		Kg. Sg. Kapal	NM		0.170	NA
		Taman Rengit Jaya	NM		0.145	NA
		Kg. Sg. Buntu	NM		0.136	NA
		Kg. Bukit Buloh	NM		0.153	NA
		Kg. Sg. Rengit	NM		0.120	NA
		Kg. Bukit Gelugor	NM		0.110	NA
		Kg. Lepau	NM		0.253	NA
		Kg. Pasir Gogok	NM		0.083	NA

Note:

All concentration unit in $\mu\text{g}/\text{m}^3$

NM = Not monitored

NA = Not Available

	<p style="text-align: center;">ADDITIONAL INFORMATION TO THE DEIA REFINERY AND PETROCHEMICAL INTEGRATED DEVELOPMENT (RAPID) PROJECT, PENGERANG JOHOR, 2012 TO INCLUDE EURO 5 MOGAS AND OLEFIN TANK UNITS</p>	
	<p style="text-align: center;">CHAPTER 4 POTENTIAL ENVIRONMENTAL IMPACT AND MITIGATION MEASURES</p>	

4.3.1.3.2 Abnormal Operating Condition

- Abnormal scenario is based on only one emission control failure event at a time or based on the worst-case pollutant load released from a selected failure event.
 - The modeling data input for normal operating conditions is as tabulated in **Table 4-17**. The modeling data input for other components within RAPID Complex is maintain in normal operation as in **Table 4-8**.
 - During abnormal operation of Refinery Cracker Complex, the waste gasses are release to atmosphere and this is expected to be temporary, thus the modeling shall be modeled for 1 hour averaging time for all parameters.
- a) Emission from the new EURO 5 MOGAS Units and Olefin Storage Tank
- No abnormal emission modeling conducted for EURO 5 MOGAS unit. Vent is routed to CHNT2 Unit to be treated before discharged to atmosphere from this emission source;
 - During abnormal operation, the emission source from Olefin Storage tankages as vent is routed to Cold Flare located within the Olefin Storage Tank boundary. The predicted GLCs of CO is below the required respective MAAQS (Standard 2020) at all receptors for the maximum 1 hour average concentration while the predicted maximum GLC of NO₂ exceeds the stipulated limit but it is located within the RAPID Complex.
- b) Cumulative Emission from RAPID Refinery Cracker Complex
- During abnormal operation, the predicted GLCs of CO is below the required respective MAAQS (Standard 2020) at all receptors for the maximum 1 hour average concentration. While predicted SO₂ and NO₂ concentrations exceed the

MAAQS (Standard 2020) at all receptors for the maximum 1 hour average concentration (**Table 4-19**)

- Analysis of source contribution of SO₂ emissions during abnormal operation scenario showed that the Refinery Tank Farm emits the highest rate of SO₂. (Table 4-15).
- Source apportionment of the predicted highest maximum 1-hour average ground level concentration of SO₂ during abnormal operation scenario also showed that the main contributor is the Refinery Tank Farm (Table 4-16).

Table 4-15: SO₂ Emission Contribution from Sources in the Refinery and Cracker Complex during Abnormal Operation

No.	Process Unit	Source ID	Total of SO ₂ emission (g/s)	Total of SO ₂ emission load (Kg/hr)	Percentage (%)
1.	Residue Fluidised	RFCC1 <i>Note1</i>	700.0	2,520.0	46
2.	Catalytic Cracking	RFCC2	25.0	90	2
3.	Crude Distillation Unit	CDU1	0.572	2.1	<1
4.		CDU2	0.572	2.1	<1
5.	Atmospheric Residue Desulphurization Unit	ARDS1	0.100	0.4	<1
6.		ARDS2	0.100	0.4	<1
7.		ARDS3	0.044	0.2	<1
8.		ARDS4	0.100	0.4	<1
9.		ARDS5	0.100	0.4	<1
10.		ARDS6	0.044	0.2	<1
11.	Diesel Hydrotreating Unit	DHT1 <i>Note1</i>	0.209	0.8	<1
12.	Kerosene Hydrotreating Unit	KHT1	0.086	0.3	<1
13.	Cracked Naphtha Hydrotreating Unit	CNHT1	0.052	0.2	<1
14.		CNHT2	0.031	0.11	<1
15.	Naphtha Hydrotreating Unit	NHT1	0.078	0.3	<1
16.	Continuous Catalytic Reformer	CCR1	0.311	1.1	<1
17.		CCR2	0.311	1.1	<1
18.		CCR3	0.311	1.1	<1
19.		CCR4	0.311	1.1	<1
20.		CCR5	-	-	-

No.	Process Unit	Source ID	Total of SO ₂ emission (g/s)	Total of SO ₂ emission load (Kg/hr)	Percentage (%)
21.	Hydrogen Production Unit	HPU1	0.229	0.8	<1
22.		HPU2	0.229	0.8	<1
23.		HPU3	0.229	0.8	<1
24.		HPU4	-	-	-
25.		HPU5	-	-	-
26.		HPU6	-	-	-
27.		HPU7	-	-	-
28.	Flare System	AF1 ^{Note1}	6.0	21.4	<1
29.	Sulphur Recovery Unit	SRU1 ^{Note1}	4.9	17.5	<1
30.		SRU2	3.4	12.4	<1
31.		SRU3	3.4	12.4	<1
32.	Sulphur Solidification Units	SSU1	0.083	0.3	<1
33.		SSU2	0.083	0.3	<1
34.		SSU3	0.083	0.3	<1
35.		SSU4	0.083	0.3	<1
36.		SSU5	0.083	0.3	<1
37.	Steam Cracker Complex	SCC1	-	-	-
38.		SCC2	-	-	-
39.		SCC3	-	-	-
40.		SCC4	-	-	-
41.		SCC5	-	-	-
42.		SCC6	-	-	-
43.		PGH1 ^{Note1}	39.2	141.1	3
44.		SCCF1 ^{Note1}	-	-	-
45.	Refinery Tank Farm	RTFF1 ^{Note1}	733.0	2,638.8	48
46.	Olefin Storage	CF1 ^{Note1}	-	-	-
TOTAL			1,519.3	5,463.6	100

Note:

Note1: Abnormal operation

Table 4-16: SO₂ Contribution to the Maximum GLC during Abnormal Operation

Pollutant	Process Unit	Maximum Concentration (µg/m ³)	Location
SO ₂ - 1 hour (Abnormal)	RFCC, LTU and PRU	295.1	Eastern Boundary of RAPID
	CDU, ARDS, HCDU and FOS	-	-
	DHT, KHT, CNHT, CCR and HPU	60.5	Bukit Pelali
	SRU and SSU	55.1	Bukit Pelali

Pollutant	Process Unit	Maximum Concentration ($\mu\text{g}/\text{m}^3$)	Location
	SCC	905.4	Bukit Pelali
	Refinery Tank Farm	40,582.8 ^{Note1}	Within RAPID
	EURO5 MOGAS	-	-
	Olefin Storage Tankages	-	-

Note:

Note1: Highest SO₂ concentration contribution

c) Cumulative Emission from RAPID Complex

- During abnormal operation, the predicted GLCs of CO is below the required respective MAAQS (Standard 2020) at all receptors for the maximum 1 hour average concentration. While predicted SO₂ and NO₂ concentrations exceed the MAAQS (Standard 2020) at all receptors for the maximum 1 hour average concentration (**Table 4-20**).



Table 4-17: Inventory of Current Air Pollution Sources and Emission Characteristics for the RAPID Refinery Cracker Complex (Abnormal Operation)

No	Source ID	Description	Stack Height (m)	Diameter (m)	Exit Velocity (m/s)	Exit Temperature (°C)	Volume Flow Rate (Nm ³ /hr)	UTM Coordinate (Zone 48 N) (m)		Emission Rate (g/s)									
								X	Y	PM ₁₀	PM _{2.5}	NO ₂	CO	SO ₂	NH ₃	NMVOC	Methanol	H ₂ S	UHC*
1	RFCC1	Flue Gas Stack ^{Note1}	109	4.5	18.23	289.94	596,455	407078.30	151599.36	22.4	7.010	41.9	27.9	700	-	-	-	-	-
2	RFCC2	Flue Gas Stack	109	4.5	14.58	60.55	683,313	407308.57	151599.36	1.5	0.460	46.4	32.0	25.0	-	-	-	-	-
3	CDU1	Crude Heater	67	2.87	12.27	201	164,621	407293.38	151114.65	0.089	0.089	2.9	1.0	0.572	-	-	-	-	-
4	CDU2	Crude Heater	67	2.87	12.27	201	164,621	407293.38	151066.95	0.089	0.089	2.9	1.0	0.572	-	-	-	-	-
5	ARDS1	Reactor Heater	61.5	1.15	12.51	164	29,229	407136.48	151467.32	0.019	0.019	0.389	0.2	0.100	-	-	-	-	-
6	ARDS2	Reactor Heater	61.5	1.15	12.51	164	29,229	407019.64	151466.58	0.019	0.019	0.389	0.2	0.100	-	-	-	-	-
7	ARDS3	Fractionator Feed Heater	50	0.65	8.64	178	6,249	407022.33	151249.38	0.008	0.008	0.169	0.1	0.044	-	-	-	-	-
8	ARDS4	Reactor Heater	61.5	1.15	8.68	164	20,280	406963.68	151466.59	0.019	0.019	0.389	0.2	0.100	-	-	-	-	-
9	ARDS5	Reactor Heater	61.5	1.15	8.68	164	20,280	407192.46	151467.33	0.019	0.019	0.389	0.2	0.100	-	-	-	-	-
10	ARDS6	Fractionator Feed Heater	50	0.65	8.64	178	6,249	407200.33	151249.39	0.008	0.008	0.169	0.1	0.044	-	-	-	-	-
11	DHT1	Diesel Hydrotreating (DHT) ^{Note1}	47.6	1.68	11.7	508	32,649	407623.24	151616.53	0.017	0.01	1.5	-	0.209	-	0.071	-	-	-
12	KHT1	Kerosene Hydrotreating (KHT)	39.85	0.88	13	325	12,998	407626.81	151726.48	0.007	0.004	0.060	-	0.086	-	0.029	-	-	-
13	CNHT1	Cracked Naphtha Hydrotreating (CNHT)	51	0.66	15	348	8,124	407626.81	151831.96	0.004	0.003	0.350	-	0.052	-	0.018	-	-	-
14	CNHT2	Cracked Naphtha Hydrotreating (CNHT) – EURO5 MOGAS unit	51	0.66	15	348	9623	407717.05	151757.31	0.011	0.011	0.744	0.117	0.031	-	0.022	-	-	-
15	NHT1	Naphtha Hydrotreating (NHT)	38.3	0.88	12	315	12,203	407593.93	151892.74	0.006	0.004	0.517	-	0.078	-	0.027	-	-	-
16	CCR1	Continuous Catalytic Reformer (CCR)	66	1.95	7.5	174.7	52,051	407661.00	151956.00	0.025	0.015	3.3	-	0.311	-	0.107	-	-	-
17	CCR2	Continuous Catalytic Reformer (CCR)	66	1.95	7.5	174.7	52,051	407661.00	151956.00	0.025	0.015	3.3	-	0.311	-	0.107	-	-	-
18	CCR3	Continuous Catalytic Reformer (CCR)	66	1.95	7.5	174.7	52,051	407661.00	151956.00	0.025	0.015	3.3	-	0.311	-	0.107	-	-	-



CHAPTER 4
POTENTIAL ENVIRONMENTAL IMPACT AND MITIGATION MEASURES

No	Source ID	Description	Stack Height (m)	Diameter (m)	Exit Velocity (m/s)	Exit Temperature (°C)	Volume Flow Rate (Nm ³ /hr)	UTM Coordinate (Zone 48 N) (m)		Emission Rate (g/s)									
								X	Y	PM ₁₀	PM _{2.5}	NO ₂	CO	SO ₂	NH ₃	NM VOC	Methanol	H ₂ S	UHC*
19	CCR4	Continuous Catalytic Reformer (CCR)	66	1.95	7.5	174.7	52,051	407661.00	151956.00	0.025	0.015	3.3	-	0.311	-	0.107	-	-	-
20	CCR5	Continuous Catalytic Reformer (CCR)	23.2	0.64	0.46	44	344	407661.00	151948.88	-	-	-	-	-	-	-	-	-	-
21	HPU1	Hydrogen Production (HPU) <small>Note1</small>	45	2.75	10.3	150	142,168	407510.45	151421.28	-	-	9.2	2.2	0.299	-	0.586	-	-	-
22	HPU2	Hydrogen Production (HPU) <small>Note1</small>	45	2.75	10.3	150	142,168	407605.62	151421.21	-	-	9.2	2.2	0.299	-	0.586	-	-	-
23	HPU3	Hydrogen Production (HPU) <small>Note1</small>	45	2.75	10.3	150	142,168	407707.59	151421.15	-	-	9.2	2.2	0.299	-	0.586	-	-	-
24	HPU4	Hydrogen Production (HPU) Degasifier Vent	21.2	0.08	10.224	40	161	407476.60	151491.27	-	-	-	0.527	-	0.002	-	-	-	-
25	HPU5	Hydrogen Production (HPU) Degasifier Vent	21.2	0.08	10.224	40	161	407571.68	151491.21	-	-	-	0.527	-	0.002	-	0.045	-	-
26	HPU6	Hydrogen Production (HPU) Degasifier Vent	21.2	0.08	10.224	40	161	407667.65	151491.15	-	-	-	0.527	-	0.002	-	0.045	-	-
27	HPU7	Hydrogen Production (HPU) CO2 stripper vent	22.2	0.25	22	50	3,286	407621.66	151342.13	-	-	-	1.4	-	-	-	0.045	-	-
28	AF1	Acid Flare System <small>Note1</small>	92	1.83	20	1000	40,630	406610.19	152213.44	0.497	0.298	0.214	1.2	6.0	-	1.9	-	-	-
29	SRU1	SRU Unit 1 <small>Note1</small>	105	2.5	10.7	352	82,618	407213.08	152216.63	-	-	14.6	3.2	4.9	-	-	-	0.222	-
30	SRU2	SRU Unit 2	105	2.5	8.38	74.3	116,419	407312.43	152216.63	-	-	10.3	2.3	3.4	-	-	-	0.167	-
31	SRU3	SRU Unit 3	105	2.5	8.38	74.3	116,419	407417.96	152216.63	-	-	10.3	2.3	3.4	-	-	-	0.167	-
32	SSU1	SSU Unit 1	12.1	0.39	15.32	80	5,096	407711.37	152231.87	-	-	-	-	0.083	-	-	-	-	-
33	SSU2	SSU Unit 2	12.1	0.39	15.32	80	5,096	407711.37	152217.22	-	-	-	-	0.083	-	-	-	-	-
34	SSU3	SSU Unit 3	12.1	0.39	15.32	80	5,096	407711.37	152201.93	-	-	-	-	0.083	-	-	-	-	-
35	SSU4	SSU Unit 4	12.1	0.39	15.32	80	5,096	407711.37	152190.08	-	-	-	-	0.083	-	-	-	-	-
36	SSU5	SSU Unit 5	12.1	0.39	15.32	80	5,096	407711.37	152178.23	-	-	-	-	0.083	-	-	-	-	-



CHAPTER 4
POTENTIAL ENVIRONMENTAL IMPACT AND MITIGATION MEASURES

No	Source ID	Description	Stack Height (m)	Diameter (m)	Exit Velocity (m/s)	Exit Temperature (°C)	Volume Flow Rate (Nm ³ /hr)	UTM Coordinate (Zone 48 N) (m)		Emission Rate (g/s)									
								X	Y	PM ₁₀	PM _{2.5}	NO ₂	CO	SO ₂	NH ₃	NMVOC	Methanol	H ₂ S	UHC*
37	SCC1	Cracking Heater (normal)	59.2	3.3	10.1	112.85	220,067	406166.00	151560.20	0.145	0.116	8.6	2.6	-	-	-	-	-	-
38	SCC2	Cracking Heater (normal)	59.2	3.3	10.1	112.85	220,067	406166.00	151541.20	0.145	0.116	8.6	2.6	-	-	-	-	-	-
39	SCC3	Cracking Heater (normal)	59.2	3.3	10	105.85	221,913	406166.00	151522.00	0.147	0.117	8.7	2.6	-	-	-	-	-	-
40	SCC4	Cracking Heater (normal)	59.2	3.3	10	105.85	221,913	406166.00	151502.50	0.147	0.117	8.7	2.6	-	-	-	-	-	-
41	SCC5	Cracking Heater (normal)	59.2	3.3	10	105.85	221,913	406165.90	151483.10	0.147	0.117	8.7	2.6	-	-	-	-	-	-
42	SCC6	Cracking Heater (decoking)	59.2	3.3	11.1	299.85	162,926	406165.90	151463.70	1.8	1.8	7.5	1.8	-	-	-	-	-	-
43	SCCF1	SCC Flare ^{Note1}	150	2.2	0.241	1000	708	406000.00	152230.00	2.2	2.8	1.4	5.6	-	-	-	-	-	-
44	PGH1	PGH Second Stage Reactor ^{Note1}	34.4	0.976	33.7	479.85	32925	405905.00	151635.00	-	-	-	-	39.2	-	-	-	-	-
45	RTFF1	Refinery Tank Farm Flare ^{Note1}	24	0.4572	20	1000	2536	406831.06	149597.35	-	-	35.0	-	733.0	-	-	-	8.0	72.0
46	CF1	Olefin Storage Cold Flare ^{Note1}	24	0.4572	20	1000	2536	406893.14	149657.04	-	-	5.7	30.8	-	-	-	-	-	-

Note:

Note1: Abnormal operation

UHC*: unburnt hydrocarbon



Table 4-18: Predicted Incremental GLC and Cumulative GLC for Olefin Storage Tank (Abnormal Operation)

No	Scenario	Receptor	Baseline (Oct 2012)	Abnormal Operating Scenario		
				Max Incremental ($\mu\text{g}/\text{m}^3$)	Receptor Incremental ($\mu\text{g}/\text{m}^3$)	Cumulative GLC ($\mu\text{g}/\text{m}^3$)
	Olefin Storage Tank Pollutant: NO₂ Tier1 1 hr Average Limit: 280 $\mu\text{g}/\text{m}^3$	Tg. Pengelih	<5	308.1 (Within RAPID)	9.7	14.7
		Pengelih Naval Base	<5		128.7	133.7
		Kg. Pengerang	<5		12.0	17.0
		Kg. Sg. Kapal	<5		30.0	35.0
		Taman Rengit Jaya	<5		25.4	30.4
		Kg. Sg. Buntu	<5		21.5	26.5
		Kg. Bukit Buloh	<5		38.6	43.6
		Kg. Sg. Rengit	ND		16.2	16.2
		Kg. Bukit Gelugor	<5		13.5	18.5
		Kg. Lepau	<5		24.4	29.4
		Kg. Pasir Gogok	ND		14.1	14.1
	Olefin Storage Tank Pollutant: CO 1 hr Average Limit: 30,000 $\mu\text{g}/\text{m}^3$	Tg. Pengelih	NM	1814.0 (Western RAPID Boundary)	99.1	NA
		Pengelih Naval Base	NM		714.3	NA
		Kg. Pengerang	NM		112.1	NA
		Kg. Sg. Kapal	NM		172.8	NA
		Taman Rengit Jaya	NM		160.9	NA
		Kg. Sg. Buntu	NM		132.1	NA
		Kg. Bukit Buloh	NM		222.2	NA
		Kg. Sg. Rengit	NM		111.3	NA
		Kg. Bukit Gelugor	NM		87.7	NA
		Kg. Lepau	NM		147.5	NA
		Kg. Pasir Gogok	NM		84.8	NA



Table 4-19: Predicted Incremental GLC and Cumulative GLC for Refinery Cracker Complex (Abnormal Operation)

No	Scenario	Receptor	Baseline (Oct 2012)	Abnormal Operating Scenario		
				Max Incremental ($\mu\text{g}/\text{m}^3$)	Receptor Incremental ($\mu\text{g}/\text{m}^3$)	Cumulative GLC ($\mu\text{g}/\text{m}^3$)
	Refinery Cracker Complex Pollutant: PM₁₀ 1 hr Average Limit: NA	Tg. Pengelih	NM	35.1 (Bukit Pelali)	6.3	NA
		Pengelih Naval Base	NM		16.5	NA
		Kg. Penerang	NM		6.1	NA
		Kg. Sg. Kapal	NM		11.7	NA
		Taman Rengit Jaya	NM		9.9	NA
		Kg. Sg. Buntu	NM		7.6	NA
		Kg. Bukit Buloh	NM		12.1	NA
		Kg. Sg. Rengit	NM		9.9	NA
		Kg. Bukit Gelugor	NM		9.4	NA
		Kg. Lepau	NM		11.7	NA
		Kg. Pasir Gogok	NM		7.7	NA
	Refinery Cracker Complex Pollutant: PM_{2.5} 1 hr Average Limit: NA	Tg. Pengelih	NM	13.3 (Bukit Penerang)	2.5	NA
		Pengelih Naval Base	NM		3.3	NA
		Kg. Penerang	NM		2.4	NA
		Kg. Sg. Kapal	NM		4.5	NA
		Taman Rengit Jaya	NM		4.1	NA
		Kg. Sg. Buntu	NM		2.9	NA
		Kg. Bukit Buloh	NM		4.5	NA
		Kg. Sg. Rengit	NM		3.5	NA
		Kg. Bukit Gelugor	NM		3.5	NA
		Kg. Lepau	NM		4.0	NA
		Kg. Pasir Gogok	NM		2.7	NA



CHAPTER 4
POTENTIAL ENVIRONMENTAL IMPACT AND MITIGATION MEASURES

No	Scenario	Receptor	Baseline (Oct 2012)	Abnormal Operating Scenario		
				Max Incremental ($\mu\text{g}/\text{m}^3$)	Receptor Incremental ($\mu\text{g}/\text{m}^3$)	Cumulative GLC ($\mu\text{g}/\text{m}^3$)
	Refinery Cracker Complex Pollutant: NO₂ Tier1 1 hr Average Limit: 280 $\mu\text{g}/\text{m}^3$	Tg. Pengelih	<5	2073.8 (Within RAPID)	81.7	86.7
		Pengelih Naval Base	<5		923.4	928.4
		Kg. Pengerang	<5		90.5	95.5
		Kg. Sg. Kapal	<5		208.6	213.6
		Taman Rengit Jaya	<5		187.7	192.7
		Kg. Sg. Buntu	<5		157.1	162.1
		Kg. Bukit Buloh	<5		295.3	300.3
		Kg. Sg. Rengit	ND		119.2	119.2
		Kg. Bukit Gelugor	<5		112.5	117.5
		Kg. Lepau	<5		170.2	175.2
		Kg. Pasir Gogok	ND		106.8	106.8
	Refinery Cracker Complex Pollutant: SO₂ 1 hr Average Limit: 250 $\mu\text{g}/\text{m}^3$	Tg. Pengelih	<5	40582.8 (Within RAPID)	1298.9	1303.9
		Pengelih Naval Base	<5		16620.7	16625.7
		Kg. Pengerang	<5		1542.3	1547.3
		Kg. Sg. Kapal	<5		3740.9	3745.9
		Taman Rengit Jaya	<5		3436.2	3441.2
		Kg. Sg. Buntu	<5		2865.0	2870.0
		Kg. Bukit Buloh	<5		5397.5	5402.5
		Kg. Sg. Rengit	ND		2051.7	2051.7
		Kg. Bukit Gelugor	<5		1700.7	1705.7
		Kg. Lepau	<5		3056.3	3061.3
		Kg. Pasir Gogok	ND		1890.4	1890.4
	Refinery Cracker Complex	Tg. Pengelih	NM	1814.0 (Western Boundary of	99.1	NA
		Pengelih Naval Base	NM		714.5	NA



CHAPTER 4
POTENTIAL ENVIRONMENTAL IMPACT AND MITIGATION MEASURES

No	Scenario	Receptor	Baseline (Oct 2012)	Abnormal Operating Scenario		
				Max Incremental ($\mu\text{g}/\text{m}^3$)	Receptor Incremental ($\mu\text{g}/\text{m}^3$)	Cumulative GLC ($\mu\text{g}/\text{m}^3$)
	Pollutant: CO 1 hr Average Limit: 30,000 $\mu\text{g}/\text{m}^3$	Kg. Pengerang	NM	RAPID)	112.1	NA
		Kg. Sg. Kapal	NM		173.2	NA
		Taman Rengit Jaya	NM		160.9	NA
		Kg. Sg. Buntu	NM		132.1	NA
		Kg. Bukit Buloh	NM		455.5	NA
		Kg. Sg. Rengit	NM		111.3	NA
		Kg. Bukit Gelugor	NM		87.7	NA
		Kg. Lepau	NM		147.8	NA
		Kg. Pasir Gogok	NM		84.9	NA
	Refinery Cracker Complex Pollutant: NMVOC 1 hr Average Limit: NA	Tg. Pengelih	NM	57.3 (Bukit Pelali)	1.9	NA
		Pengelih Naval Base	NM		26.0	NA
		Kg. Pengerang	NM		2.5	NA
		Kg. Sg. Kapal	NM		3.3	NA
		Taman Rengit Jaya	NM		2.6	NA
		Kg. Sg. Buntu	NM		2.8	NA
		Kg. Bukit Buloh	NM		3.6	NA
		Kg. Sg. Rengit	NM		2.7	NA
		Kg. Bukit Gelugor	NM		2.3	NA
		Kg. Lepau	NM		3.4	NA
Kg. Pasir Gogok	NM	2.4	NA			
	Refinery Cracker Complex	Tg. Pengelih	NM	456.1 (Within RAPID)	24.5	NA
		Pengelih Naval Base	NM		182.3	NA



ADDITIONAL INFORMATION TO THE DEIA REFINERY AND PETROCHEMICAL INTEGRATED DEVELOPMENT (RAPID) PROJECT, PENGERANG JOHOR, 2012 TO INCLUDE EURO 5 MOGAS AND OLEFIN TANK UNITS



CHAPTER 4
POTENTIAL ENVIRONMENTAL IMPACT AND MITIGATION MEASURES

No	Scenario	Receptor	Baseline (Oct 2012)	Abnormal Operating Scenario		
				Max Incremental ($\mu\text{g}/\text{m}^3$)	Receptor Incremental ($\mu\text{g}/\text{m}^3$)	Cumulative GLC ($\mu\text{g}/\text{m}^3$)
	Pollutant: H₂S 1 hr Average Limit: NA	Kg. Pengerang	NM		31.3	NA
		Kg. Sg. Kapal	NM		45.8	NA
		Taman Rengit Jaya	NM		50.1	NA
		Kg. Sg. Buntu	NM		39.9	NA
		Kg. Bukit Buloh	NM		62.8	NA
		Kg. Sg. Rengit	NM		29.1	NA
		Kg. Bukit Gelugor	NM		22.1	NA
		Kg. Lepau	NM		38.4	NA
		Kg. Pasir Gogok	NM		22.0	NA
	Refinery Cracker Complex Pollutant: UHC 1 hr Average Limit: NA	Tg. Pengelih	NM	4104.6 (Within RAPID)	220.8	NA
		Pengelih Naval Base	NM		1640.3	NA
		Kg. Pengerang	NM		282.0	NA
		Kg. Sg. Kapal	NM		412.0	NA
		Taman Rengit Jaya	NM		450.5	NA
		Kg. Sg. Buntu	NM		358.8	NA
		Kg. Bukit Buloh	NM		565.5	NA
		Kg. Sg. Rengit	NM		261.9	NA
		Kg. Bukit Gelugor	NM		198.7	NA
		Kg. Lepau	NM		345.2	NA
Kg. Pasir Gogok	NM	198.3	NA			



Table 4-20: Predicted Incremental GLC and Cumulative GLC for RAPID Complex (Abnormal Operation)

No	Scenario	Receptor	Baseline (Oct 2012)	Abnormal Operating Scenario		
				Max Incremental ($\mu\text{g}/\text{m}^3$)	Receptor Incremental ($\mu\text{g}/\text{m}^3$)	Cumulative GLC ($\mu\text{g}/\text{m}^3$)
	Refinery Cracker Complex Pollutant: PM₁₀ 1 hr Average Limit: NA	Tg. Pengelih	NM	35.1 (Bukit Pelali)	7.2	NA
		Pengelih Naval Base	NM		22.8	NA
		Kg. Penerang	NM		7.0	NA
		Kg. Sg. Kapal	NM		12.6	NA
		Taman Rengit Jaya	NM		11.0	NA
		Kg. Sg. Buntu	NM		8.2	NA
		Kg. Bukit Buloh	NM		13.0	NA
		Kg. Sg. Rengit	NM		10.5	NA
		Kg. Bukit Gelugor	NM		10.2	NA
		Kg. Lepau	NM		12.0	NA
		Kg. Pasir Gogok	NM		8.4	NA
	Refinery Cracker Complex Pollutant: PM_{2.5} 1 hr Average Limit: NA	Tg. Pengelih	NM	14.7 (Bukit Penerang)	3.1	NA
		Pengelih Naval Base	NM		13.6	NA
		Kg. Penerang	NM		3.1	NA
		Kg. Sg. Kapal	NM		5.1	NA
		Taman Rengit Jaya	NM		4.8	NA
		Kg. Sg. Buntu	NM		3.6	NA
		Kg. Bukit Buloh	NM		5.1	NA
		Kg. Sg. Rengit	NM		4.0	NA
		Kg. Bukit Gelugor	NM		4.1	NA
		Kg. Lepau	NM		4.6	NA
		Kg. Pasir Gogok	NM		3.3	NA



CHAPTER 4
POTENTIAL ENVIRONMENTAL IMPACT AND MITIGATION MEASURES

No	Scenario	Receptor	Baseline (Oct 2012)	Abnormal Operating Scenario		
				Max Incremental ($\mu\text{g}/\text{m}^3$)	Receptor Incremental ($\mu\text{g}/\text{m}^3$)	Cumulative GLC ($\mu\text{g}/\text{m}^3$)
	Refinery Cracker Complex Pollutant: NO₂ Tier1 1 hr Average Limit: 280 $\mu\text{g}/\text{m}^3$	Tg. Pengelih	<5	2073.8 (Within RAPID)	87.4	92.4
		Pengelih Naval Base	<5		931.1	936.1
		Kg. Pengerang	<5		95.0	100.0
		Kg. Sg. Kapal	<5		208.7	213.7
		Taman Rengit Jaya	<5		188.0	193.0
		Kg. Sg. Buntu	<5		158.5	163.5
		Kg. Bukit Buloh	<5		295.3	300.3
		Kg. Sg. Rengit	ND		127.2	127.2
		Kg. Bukit Gelugor	<5		121.6	126.6
		Kg. Lepau	<5		175.8	180.8
		Kg. Pasir Gogok	ND		112.1	112.1
	Refinery Cracker Complex Pollutant: SO₂ 1 hr Average Limit: 250 $\mu\text{g}/\text{m}^3$	Tg. Pengelih	<5	40582.8 (Within RAPID)	1298.9	1303.9
		Pengelih Naval Base	<5		16620.7	16625.7
		Kg. Pengerang	<5		1542.3	1547.3
		Kg. Sg. Kapal	<5		3740.9	3745.9
		Taman Rengit Jaya	<5		3436.2	3441.2
		Kg. Sg. Buntu	<5		2865.0	2870.0
		Kg. Bukit Buloh	<5		5397.5	5402.5
		Kg. Sg. Rengit	ND		2051.7	2051.7
		Kg. Bukit Gelugor	<5		1700.7	1705.7
		Kg. Lepau	<5		3056.3	3061.3
		Kg. Pasir Gogok	ND		1890.4	1890.4
	Refinery Cracker Complex	Tg. Pengelih	NM	1814.1 (Western Boundary of	99.5	NA
		Pengelih Naval Base	NM		744.4	NA



CHAPTER 4
POTENTIAL ENVIRONMENTAL IMPACT AND MITIGATION MEASURES

No	Scenario	Receptor	Baseline (Oct 2012)	Abnormal Operating Scenario		
				Max Incremental ($\mu\text{g}/\text{m}^3$)	Receptor Incremental ($\mu\text{g}/\text{m}^3$)	Cumulative GLC ($\mu\text{g}/\text{m}^3$)
	Pollutant: CO 1 hr Average Limit: 30,000 $\mu\text{g}/\text{m}^3$	Kg. Pengerang	NM	RAPID)	112.1	NA
		Kg. Sg. Kapal	NM		174.5	NA
		Taman Rengit Jaya	NM		160.9	NA
		Kg. Sg. Buntu	NM		142.3	NA
		Kg. Bukit Buloh	NM		455.6	NA
		Kg. Sg. Rengit	NM		111.3	NA
		Kg. Bukit Gelugor	NM		93.5	NA
		Kg. Lepau	NM		184.9	NA
		Kg. Pasir Gogok	NM		107.1	NA
	Refinery Cracker Complex Pollutant: NMVOC 1 hr Average Limit: NA	Tg. Pengelih	NM	57.3 (Bukit Pelali)	1.9	NA
		Pengelih Naval Base	NM		26.0	NA
		Kg. Pengerang	NM		2.5	NA
		Kg. Sg. Kapal	NM		3.3	NA
		Taman Rengit Jaya	NM		2.6	NA
		Kg. Sg. Buntu	NM		2.8	NA
		Kg. Bukit Buloh	NM		3.6	NA
		Kg. Sg. Rengit	NM		2.7	NA
		Kg. Bukit Gelugor	NM		2.3	NA
		Kg. Lepau	NM		3.4	NA
Kg. Pasir Gogok	NM	2.4	NA			
	Refinery Cracker Complex	Tg. Pengelih	NM	456.1 (Within RAPID)	24.5	NA
		Pengelih Naval Base	NM		182.3	NA



CHAPTER 4
POTENTIAL ENVIRONMENTAL IMPACT AND MITIGATION MEASURES



No	Scenario	Receptor	Baseline (Oct 2012)	Abnormal Operating Scenario		
				Max Incremental ($\mu\text{g}/\text{m}^3$)	Receptor Incremental ($\mu\text{g}/\text{m}^3$)	Cumulative GLC ($\mu\text{g}/\text{m}^3$)
	Pollutant: H₂S 1 hr Average Limit: NA	Kg. Pengerang	NM		31.3	NA
		Kg. Sg. Kapal	NM		45.8	NA
		Taman Rengit Jaya	NM		50.1	NA
		Kg. Sg. Buntu	NM		39.9	NA
		Kg. Bukit Buloh	NM		62.8	NA
		Kg. Sg. Rengit	NM		29.1	NA
		Kg. Bukit Gelugor	NM		22.1	NA
		Kg. Lepau	NM		38.4	NA
		Kg. Pasir Gogok	NM		22.0	NA
	Refinery Cracker Complex Pollutant: UHC 1 hr Average Limit: NA	Tg. Pengelih	NM	4104.6 Within RAPID)	220.8	NA
		Pengelih Naval Base	NM		1640.3	NA
		Kg. Pengerang	NM		282.0	NA
		Kg. Sg. Kapal	NM		412.0	NA
		Taman Rengit Jaya	NM		450.5	NA
		Kg. Sg. Buntu	NM		358.8	NA
		Kg. Bukit Buloh	NM		565.5	NA
		Kg. Sg. Rengit	NM		261.9	NA
		Kg. Bukit Gelugor	NM		198.7	NA
		Kg. Lepau	NM		345.2	NA
Kg. Pasir Gogok	NM	198.3	NA			

4.3.1.3.3 Emergency Operating Condition

- Operating philosophy for all RAPID facility shall be during fire and power failure cases is vent shall be routed to the flare system.
- Emergency scenario is based on full load of the refinery flare in the event of total failure of all emission controls in the refinery and all untreated emissions are directed to the refinery flare.
- For the selection of emergency air dispersion modeling scenario shall be one flare failure at a time and selection of the worst-case scenario will be from the highest flare load. The highest flare load shall be from the Refinery Flare (RF1 as in **Table 4-5**).
- Study had been made by considering Refinery flare in the event where there is general electrical power failure where the load is coming from refinery flare and acid flare load. Model data input for refinery flare stack as below:

Height:	92 meters
Diameter:	2.13 meters
Exit Velocity:	20 m/s <small>(default value)</small>
Exit Temperature:	1000 °C <small>(default value)</small>
Volume flow rate:	21,503,453 Nm ³ /hr
Pollutant Emission Rate (g/s):	
➤ PM ₁₀ :	608.3
➤ PM _{2.5} :	365.0
➤ NO ₂ :	492.9
➤ CO:	2682.2
➤ SO ₂ :	6366.0
➤ NMVOC:	5397.2
➤ H ₂ S:	69.3

- The other RAPID components remained as in normal operating condition (**Table 4-8**). During emergency operation of Refinery Cracker Complex, the waste gasses are flared and this is expected to be temporary, thus the modelling shall be modelled for 1 hour

	<p style="text-align: center;">ADDITIONAL INFORMATION TO THE DEIA REFINERY AND PETROCHEMICAL INTEGRATED DEVELOPMENT (RAPID) PROJECT, PENGERANG JOHOR, 2012 TO INCLUDE EURO 5 MOGAS AND OLEFIN TANK UNITS</p>	
	<p style="text-align: center;">CHAPTER 4 POTENTIAL ENVIRONMENTAL IMPACT AND MITIGATION MEASURES</p>	

averaging time for all parameters. This assumption represents the most conservative estimation of emergency operation.

- However, this modeling does not take into account the event within the process line where the relief valves may release the vent directly to atmosphere during emergency scenario.
- The modeling shall only consider the emission via point sources. Venting to atmosphere via the relief valves is highlighted/covered /modeled in the QRA studies.

a) Cumulative Emission from RAPID Refinery Cracker Complex

- During emergency operation, the predicted GLCs of CO, SO₂ and NO₂ are below the required respective MAAQS (Standard 2020) at all receptors and the predicted maximum 1 hour average concentration for the prescribed parameters were well within the MAAQS (Standard 2020) (**Table 4-21**).

b) Cumulative Emission from RAPID Complex

- During emergency operation, the predicted GLCs of CO, SO₂ and NO₂ are below the required respective MAAQS (Standard 2020) at all receptors and the predicted maximum 1 hour average concentration for all parameters were well within the MAAQS (Standard 2020) (**Table 4-22**).



Table 4-21 Predicted Incremental GLC and Cumulative GLC for Refinery Cracker Complex (Emergency Operation)

No	Scenario	Receptor	Baseline (Oct 2012)	Emergency Operating Scenario		
				Max Incremental ($\mu\text{g}/\text{m}^3$)	Receptor Incremental ($\mu\text{g}/\text{m}^3$)	Cumulative GLC ($\mu\text{g}/\text{m}^3$)
	Refinery Cracker Complex Pollutant: PM₁₀ 1 hr Average Limit: NA	Tg. Pengelih	NM	11.5 (Ocean – Southern of RAPID)	8.7	NA
		Pengelih Naval Base	NM		9.5	NA
		Kg. Penerang	NM		7.6	NA
		Kg. Sg. Kapal	NM		9.5	NA
		Taman Rengit Jaya	NM		8.8	NA
		Kg. Sg. Buntu	NM		8.1	NA
		Kg. Bukit Buloh	NM		9.1	NA
		Kg. Sg. Rengit	NM		9.9	NA
		Kg. Bukit Gelugor	NM		10.2	NA
		Kg. Lepau	NM		9.0	NA
		Kg. Pasir Gogok	NM		9.9	NA
	Refinery Cracker Complex Pollutant: PM_{2.5} 1 hr Average Limit: NA	Tg. Pengelih	NM	6.9 (Ocean – Southern of RAPID)	5.2	NA
		Pengelih Naval Base	NM		5.7	NA
		Kg. Penerang	NM		4.6	NA
		Kg. Sg. Kapal	NM		5.7	NA
		Taman Rengit Jaya	NM		5.3	NA
		Kg. Sg. Buntu	NM		4.9	NA
		Kg. Bukit Buloh	NM		5.5	NA
		Kg. Sg. Rengit	NM		5.9	NA
		Kg. Bukit Gelugor	NM		6.1	NA
		Kg. Lepau	NM		5.4	NA
		Kg. Pasir Gogok	NM		6.0	NA



CHAPTER 4
POTENTIAL ENVIRONMENTAL IMPACT AND MITIGATION MEASURES

No	Scenario	Receptor	Baseline (Oct 2012)	Emergency Operating Scenario		
				Max Incremental ($\mu\text{g}/\text{m}^3$)	Receptor Incremental ($\mu\text{g}/\text{m}^3$)	Cumulative GLC ($\mu\text{g}/\text{m}^3$)
	Refinery Cracker Complex Pollutant: NO₂ Tier1 1 hr Average Limit: 280 $\mu\text{g}/\text{m}^3$	Tg. Pengelih	<5	9.3 (Ocean – Southern of RAPID)	7.1	12.1
		Pengelih Naval Base	<5		7.7	12.7
		Kg. Pengerang	<5		6.2	11.2
		Kg. Sg. Kapal	<5		7.7	12.7
		Taman Rengit Jaya	<5		7.1	12.1
		Kg. Sg. Buntu	<5		6.6	11.6
		Kg. Bukit Buloh	<5		7.4	12.4
		Kg. Sg. Rengit	ND		8.0	8.0
		Kg. Bukit Gelugor	<5		8.2	13.2
		Kg. Lepau	<5		7.3	12.3
Kg. Pasir Gogok	ND	8.1	8.1			
	Refinery Cracker Complex Pollutant: SO₂ 1 hr Average Limit: 250 $\mu\text{g}/\text{m}^3$	Tg. Pengelih	<5	120.4 (Ocean – Southern of RAPID)	91.1	96.1
		Pengelih Naval Base	<5		99.7	104.7
		Kg. Pengerang	<5		80.0	85.0
		Kg. Sg. Kapal	<5		99.3	104.3
		Taman Rengit Jaya	<5		92.2	97.2
		Kg. Sg. Buntu	<5		84.7	89.7
		Kg. Bukit Buloh	<5		95.5	100.5
		Kg. Sg. Rengit	ND		103.3	103.3
		Kg. Bukit Gelugor	<5		106.5	111.5
		Kg. Lepau	<5		93.8	98.8
Kg. Pasir Gogok	ND	104.1	104.1			
	Refinery Cracker Complex	Tg. Pengelih	NM	50.7 (Ocean – Southern of	38.4	NA
		Pengelih Naval Base	NM		42.0	NA



CHAPTER 4
POTENTIAL ENVIRONMENTAL IMPACT AND MITIGATION MEASURES

No	Scenario	Receptor	Baseline (Oct 2012)	Emergency Operating Scenario		
				Max Incremental ($\mu\text{g}/\text{m}^3$)	Receptor Incremental ($\mu\text{g}/\text{m}^3$)	Cumulative GLC ($\mu\text{g}/\text{m}^3$)
	Pollutant: CO 1 hr Average Limit: 30,000 $\mu\text{g}/\text{m}^3$	Kg. Pengerang	NM	RAPID)	33.7	NA
		Kg. Sg. Kapal	NM		41.8	NA
		Taman Rengit Jaya	NM		38.9	NA
		Kg. Sg. Buntu	NM		35.7	NA
		Kg. Bukit Buloh	NM		40.3	NA
		Kg. Sg. Rengit	NM		43.5	NA
		Kg. Bukit Gelugor	NM		44.9	NA
		Kg. Lepau	NM		39.5	NA
		Kg. Pasir Gogok	NM		43.8	NA
	Refinery Cracker Complex Pollutant: NMVOC 1 hr Average Limit: NA	Tg. Pengelih	NM	102.1 (Ocean – Southern of RAPID)	77.3	NA
		Pengelih Naval Base	NM		84.5	NA
		Kg. Pengerang	NM		67.9	NA
		Kg. Sg. Kapal	NM		84.2	NA
		Taman Rengit Jaya	NM		78.2	NA
		Kg. Sg. Buntu	NM		71.8	NA
		Kg. Bukit Buloh	NM		81.0	NA
		Kg. Sg. Rengit	NM		87.6	NA
		Kg. Bukit Gelugor	NM		90.3	NA
		Kg. Lepau	NM		79.6	NA
Kg. Pasir Gogok	NM	88.2	NA			
	Refinery Cracker Complex	Tg. Pengelih	NM	1.3 (Ocean – Southern of	0.992	NA
		Pengelih Naval Base	NM		1.085	NA



CHAPTER 4
POTENTIAL ENVIRONMENTAL IMPACT AND MITIGATION MEASURES

No	Scenario	Receptor	Baseline (Oct 2012)	Emergency Operating Scenario		
				Max Incremental ($\mu\text{g}/\text{m}^3$)	Receptor Incremental ($\mu\text{g}/\text{m}^3$)	Cumulative GLC ($\mu\text{g}/\text{m}^3$)
	Pollutant: H_2S 1 hr Average Limit: NA	Kg. Pengerang	NM	RAPID)	0.871	NA
		Kg. Sg. Kapal	NM		1.081	NA
		Taman Rengit Jaya	NM		1.004	NA
		Kg. Sg. Buntu	NM		0.922	NA
		Kg. Bukit Buloh	NM		1.040	NA
		Kg. Sg. Rengit	NM		1.125	NA
		Kg. Bukit Gelugor	NM		1.160	NA
		Kg. Lepau	NM		1.022	NA
		Kg. Pasir Gogok	NM		1.133	NA

Note:

All concentration unit in $\mu\text{g}/\text{m}^3$

NM = Not monitored

NA = Not Available



Table 4-22 Predicted Incremental GLC and Cumulative GLC for Cumulative RAPID Complex (Emergency Operation)

No	Scenario	Receptor	Baseline (Oct 2012)	Emergency Operating Scenario		
				Max Incremental ($\mu\text{g}/\text{m}^3$)	Receptor Incremental ($\mu\text{g}/\text{m}^3$)	Cumulative GLC ($\mu\text{g}/\text{m}^3$)
	Cumulative RAPID Complex Pollutant: PM₁₀ 1 hr Average Limit: 100 $\mu\text{g}/\text{m}^3$	Tg. Pengelih	NM	21.7 (Bukit Pengerang)	8.9	NA
		Pengelih Naval Base	NM		21.7	NA
		Kg. Pengerang	NM		7.8	NA
		Kg. Sg. Kapal	NM		10.0	NA
		Taman Rengit Jaya	NM		9.2	NA
		Kg. Sg. Buntu	NM		8.3	NA
		Kg. Bukit Buloh	NM		9.3	NA
		Kg. Sg. Rengit	NM		10.1	NA
		Kg. Bukit Gelugor	NM		10.5	NA
		Kg. Lepau	NM		9.4	NA
		Kg. Pasir Gokok	NM		10.2	NA
	Cumulative RAPID Complex Pollutant: PM_{2.5} 1 hr Average Limit: 35 $\mu\text{g}/\text{m}^3$	Tg. Pengelih	NM	12.4 (Bukit Pengerang)	5.4	NA
		Pengelih Naval Base	NM		12.4	NA
		Kg. Pengerang	NM		4.7	NA
		Kg. Sg. Kapal	NM		6.1	NA
		Taman Rengit Jaya	NM		5.7	NA
		Kg. Sg. Buntu	NM		5.0	NA
		Kg. Bukit Buloh	NM		5.6	NA
		Kg. Sg. Rengit	NM		6.2	NA
		Kg. Bukit Gelugor	NM		6.4	NA
		Kg. Lepau	NM		5.8	NA



CHAPTER 4
POTENTIAL ENVIRONMENTAL IMPACT AND MITIGATION MEASURES

No	Scenario	Receptor	Baseline (Oct 2012)	Emergency Operating Scenario		
				Max Incremental ($\mu\text{g}/\text{m}^3$)	Receptor Incremental ($\mu\text{g}/\text{m}^3$)	Cumulative GLC ($\mu\text{g}/\text{m}^3$)
		Kg. Pasir Gokok	NM		6.2	NA
	Cumulative RAPID Complex Pollutant: NO₂ Tier1 1 hr Average Limit: 280 $\mu\text{g}/\text{m}^3$	Tg. Pengelih	<5	165.0 (Bukit Pengerang)	15.7	20.7
		Pengelih Naval Base	<5		165.0	170.0
		Kg. Pengerang	<5		17.0	22.0
		Kg. Sg. Kapal	<5		18.1	23.1
		Taman Rengit Jaya	<5		19.8	24.8
		Kg. Sg. Buntu	<5		16.2	21.2
		Kg. Bukit Buloh	<5		20.3	25.3
		Kg. Sg. Rengit	ND		19.4	19.4
		Kg. Bukit Gelugor	<5		21.0	26.0
		Kg. Lepau	<5		24.5	29.5
		Kg. Pasir Gokok	ND		15.8	15.8
	Cumulative RAPID Complex Pollutant: SO₂ 1 hr Average Limit: 250 $\mu\text{g}/\text{m}^3$	Tg. Pengelih	<5	120.5 (Ocean – Southern of RAPID)	91.2	96.2
		Pengelih Naval Base	<5		99.8	104.8
		Kg. Pengerang	<5		80.1	85.1
		Kg. Sg. Kapal	<5		99.5	104.5
		Taman Rengit Jaya	<5		92.4	97.4
		Kg. Sg. Buntu	<5		84.8	89.8
		Kg. Bukit Buloh	<5		95.6	100.6
		Kg. Sg. Rengit	ND		103.5	103.5
		Kg. Bukit Gelugor	<5		106.7	111.7
		Kg. Lepau	<5		94.1	99.1



CHAPTER 4
POTENTIAL ENVIRONMENTAL IMPACT AND MITIGATION MEASURES

No	Scenario	Receptor	Baseline (Oct 2012)	Emergency Operating Scenario		
				Max Incremental ($\mu\text{g}/\text{m}^3$)	Receptor Incremental ($\mu\text{g}/\text{m}^3$)	Cumulative GLC ($\mu\text{g}/\text{m}^3$)
		Kg. Pasir Gogok	ND		104.2	104.2
	Cumulative RAPID Complex Pollutant: CO 1 hr Average Limit: 30,000 $\mu\text{g}/\text{m}^3$	Tg. Pengelih	NM	546.4 (Bukit Pengerang)	42.7	NA
		Pengelih Naval Base	NM		546.4	NA
		Kg. Pengerang	NM		47.3	NA
		Kg. Sg. Kapal	NM		57.7	NA
		Taman Rengit Jaya	NM		65.8	NA
		Kg. Sg. Buntu	NM		52.3	NA
		Kg. Bukit Buloh	NM		53.2	NA
		Kg. Sg. Rengit	NM		49.8	NA
		Kg. Bukit Gelugor	NM		51.3	NA
		Kg. Lepau	NM		82.4	NA
		Kg. Pasir Gogok	NM		50.1	NA
	Cumulative RAPID Complex Pollutant: NM VOC 1 hr Average Limit: NA	Tg. Pengelih	NM	102.1 (Ocean – Southern of RAPID)	77.3	NA
		Pengelih Naval Base	NM		84.5	NA
		Kg. Pengerang	NM		67.9	NA
		Kg. Sg. Kapal	NM		84.2	NA
		Taman Rengit Jaya	NM		78.2	NA
		Kg. Sg. Buntu	NM		71.8	NA
		Kg. Bukit Buloh	NM		81.0	NA
		Kg. Sg. Rengit	NM		87.6	NA
		Kg. Bukit Gelugor	NM		90.3	NA
		Kg. Lepau	NM		79.6	NA
		Kg. Pasir Gogok	NM		88.2	NA



CHAPTER 4
POTENTIAL ENVIRONMENTAL IMPACT AND MITIGATION MEASURES



No	Scenario	Receptor	Baseline (Oct 2012)	Emergency Operating Scenario		
				Max Incremental ($\mu\text{g}/\text{m}^3$)	Receptor Incremental ($\mu\text{g}/\text{m}^3$)	Cumulative GLC ($\mu\text{g}/\text{m}^3$)
	Cumulative RAPID Complex Pollutant: H₂S 1 hr Average Limit: NA	Tg. Pengelih	NM	1.3 (Ocean – Southern of RAPID)	0.992	NA
		Pengelih Naval Base	NM		1.085	NA
		Kg. Pengerang	NM		0.871	NA
		Kg. Sg. Kapal	NM		1.081	NA
		Taman Rengit Jaya	NM		1.004	NA
		Kg. Sg. Buntu	NM		0.922	NA
		Kg. Bukit Buloh	NM		1.040	NA
		Kg. Sg. Rengit	NM		1.125	NA
		Kg. Bukit Gelugor	NM		1.160	NA
		Kg. Lepau	NM		1.022	NA
Kg. Pasir Gokok	NM	1.133	NA			

Note:

All concentration unit in $\mu\text{g}/\text{m}^3$

NM = Not monitored

NA = Not Available

	<p style="text-align: center;">ADDITIONAL INFORMATION TO THE DEIA REFINERY AND PETROCHEMICAL INTEGRATED DEVELOPMENT (RAPID) PROJECT, PENGERANG JOHOR, 2012 TO INCLUDE EURO 5 MOGAS AND OLEFIN TANK UNITS</p>	
	<p style="text-align: center;">CHAPTER 4 POTENTIAL ENVIRONMENTAL IMPACT AND MITIGATION MEASURES</p>	

4.3.2 HEALTH IMPACT ASSESSMENT

4.3.2.1 Introduction

The health impact assessment (HIA) study will focus on the existing disease burden of the sensitive communities and on any potential impacts from the new units for EURO 5 MOGAS production and Additional Olefins Storage.

The sensitive receptors are those people staying or institution located within the zone of impact (ZOI) of 5km radius from RAPID project boundaries. The current disease pattern among community members is very important as a baseline to ensure the health of present and future generations is secured and protected. Qualitative assessment is on the readiness of existing health facilities near the project site for a disaster management.



The scope of this HIA shall include:

- i. The assessment of the disease burden of the affected communities residing nearby to the proposed project site.
- ii. The estimation of the cumulative health risk status of the affected communities that based on the air dispersion modeling findings.

4.3.2.2 Applicable Regulatory Framework

In assessing the potential health impacts of the project, reference will be made to the following standards and guidelines.

- i. Guidance Document on Health Impact Assessment (HIA) in Environmental Impact Assessment (EIA) 2012.
- ii. Malaysian Ambient Air Quality Guidelines (2015).
- iii. Risk Assessment Guidance for Superfund, Volume I: Human Health Evaluation Manual (Part F, Supplemental Guidance for Inhalation Risk Assessment) USEPA 2009).
- iv. Recommended Industrial and Residential Noise level (DOE 2004)

	<p style="text-align: center;">ADDITIONAL INFORMATION TO THE DEIA REFINERY AND PETROCHEMICAL INTEGRATED DEVELOPMENT (RAPID) PROJECT, PENGERANG JOHOR, 2012 TO INCLUDE EURO 5 MOGAS AND OLEFIN TANK UNITS</p>	
	<p style="text-align: center;">CHAPTER 4 POTENTIAL ENVIRONMENTAL IMPACT AND MITIGATION MEASURES</p>	

4.3.2.3 Approach and Methodology

Further details of Health Impact Assessment methodology and approach is described in **Volume 1, Chapter 3**.

The pollutants assessed were particulates and gaseous emission parameters from the identified sources as adopted in the Air Emission Dispersion Study:



- The air pollutants that will be assessed for their health effects will be:
 - i. Fine particulate (PM_{2.5})
 - ii. Respirable particulate (PM₁₀)
 - iii. Nitrogen dioxide (NO₂)
 - iv. Sulphur dioxide (SO₂)
 - v. Carbon monoxide (CO)
 - vi. Ammonia (NH₃)
 - vii. Volatile organic compounds (VOCs)
 - viii. Non-methane volatile organic compounds (NMVOCs),
 - ix. Methanol
 - x. Hydrogen Sulfide (H₂S)
 - xi. Unburned Hydrocarbons (UHCs).

- The air pollutant health impact and reference limit is shown in **Table 4-23**.

4.3.2.3.1 Assessment Scenario

For the ambient air health risk exposure, three scenarios have been considered during the assessment that include:

- i. Normal operation scenario with cumulative emissions from Refinery Complex and other RAPID components in normal operation mode,

	<p align="center">ADDITIONAL INFORMATION TO THE DEIA REFINERY AND PETROCHEMICAL INTEGRATED DEVELOPMENT (RAPID) PROJECT, PENGERANG JOHOR, 2012 TO INCLUDE EURO 5 MOGAS AND OLEFIN TANK UNITS</p>	
	<p align="center">CHAPTER 4 POTENTIAL ENVIRONMENTAL IMPACT AND MITIGATION MEASURES</p>	

- ii. Abnormal operation scenario with unmitigated emissions from selected sources in the Refinery Complex with cumulative emissions from other RAPID components in normal operation mode, and
- iii. Emergency operation scenario with unmitigated emissions from selected sources in the Refinery Complex with cumulative emissions from other RAPID components in normal operation mode.

Further details of the emission sources are shown in **Volume 2, Appendix 1**.

4.3.2.3.2 Identification of the Receptors

Please refer to **Section 4.2**.





Table 4-23: Air Pollutant Health Impact

No.	Pollutant	Pollutant concentration (µg/m ³) for ambient air		Health Impact
		Reference Limit	Health Exposure Limit Reference	
1	Nitrogen dioxide	280 (1-hour average)	Malaysian Ambient Air Quality Standards 2013 (Standard 2020)	<ul style="list-style-type: none"> Acute exposure to NO₂ cause pulmonary edema, pneumonitis, bronchitis, and bronchiolitis obliterans. It's considered as relatively insoluble, reactive gas, such as phosgene and ozone. Once inhaled, it reaches the lower respiratory tract, affecting the bronchioles and the adjacent alveolar spaces, where it produces pulmonary edema within hours. Many deaths from pulmonary oedema have been induced by acute inhalation of high concentrations of NO₂.
2	Carbon monoxide	30000 (1-hour average) 10000 (8-hours average)	Malaysian Ambient Air Quality Standards 2013 (Standard 2020)	<ul style="list-style-type: none"> Exposure to carbon monoxide can occur through inhalation of the gas and eye or skin contact with the liquid. Inhalation of this asphyxiant gas causes tissue hypoxia by preventing the blood from carrying sufficient oxygen. Carbon monoxide combines reversibly with haemoglobin to form carboxyhemoglobin. The reduction in oxygen-carrying capacity of the blood is proportional to the amount of carboxyhemoglobin formed.
3	Sulphur Dioxide (SO ₂)	250 (1-hour average)	Malaysian Ambient Air Quality Standards 2013 (Standard 2020)	<ul style="list-style-type: none"> Studies have shown that inhalation of SO₂ by asthmatics can cause a significant degree of wheezing at concentrations considerably lower than those which affect non-asthmatics. Concentrations as low as 0.2 ppm have a significant effect, especially in subjects who are mouth breathing or undergoing heavy exercise. The effects appear to be short-lived and not increased by more prolonged exposure. The effects on moderate or severe asthmatics, or those with marked liability of their asthma, could conceivably be seen at much lower concentrations of SO₂
4	Ammonia (NH ₃)	130 (24-hours average)	Arizona Ambient Air Quality Guideline (This guideline is made as reference due to no reference limit for Ammonia (NH ₃) in Malaysian Ambient Air Quality Standards 2013 (Standard 2020))	<ul style="list-style-type: none"> Ammonia is a colourless gas with a very sharp irritating odour. Human water taste and odour thresholds for ammonia gas are at about 35 and 50 ppm concentrations, respectively. It is a non-carcinogen corrosive substance that affects skin and mucous membrane in eyes, respiratory tract, mouth, and digestive tract. There is no evidence that its exposure causes birth defects or other developmental effects.
5	Methanol	4000 (24-hours average)	Canadian Ambient Air Quality Guideline (This guideline is made as reference due to no reference limit for Methanol in Malaysian Ambient Air Quality Standards 2013 (Standard 2020))	<ul style="list-style-type: none"> Methanol is a skin and eye irritant. It causes irritation, but only minor residual injury, including those requiring the use of an approved air-purifying respirator. These materials are only slightly hazardous to health and only breathing protection is needed. Acute poisoning causes initial drowsiness, confusion and ataxia. Then the patient may experience nonspecific malaise, headache, vomiting, abdominal pain, nausea, vomiting, and visual changes. If untreated, central nervous system depression progresses to encephalopathy, rapid respirations, metabolic acidosis with hypokalemia. Visual defects are described as blurred or "snowfield" like vision. If untreated, methanol poisoning progresses to coma, metabolic acidosis, and finally respiratory or circulatory arrest. The minimum lethal dose of methanol in the absence of medical treatment is between 0.3 and 1 g/kg body weight. The immediately dangerous dose of life or health is 6000 ppm, equal to 8X10⁶ mg/m³. At this moment, no studies were found on the possible carcinogenic activity of methanol in humans or experimental animals.



CHAPTER 4
POTENTIAL ENVIRONMENTAL IMPACT AND MITIGATION MEASURES

No.	Pollutant	Pollutant concentration ($\mu\text{g}/\text{m}^3$) for ambient air		Health Impact
		Reference Limit	Health Exposure Limit Reference	
6	Hydrogen sulphide (H_2S)	270 (24-hours average)	Arizona Ambient Air Quality Guideline (This guideline is made as reference due to no reference limit for Hydrogen Sulphide (H_2S) in Malaysian Ambient Air Quality Standards 2013 (Standard 2020))	<ul style="list-style-type: none"> Exposure to low concentrations of hydrogen sulphide may cause irritation to the eyes, nose, or throat. It may also cause difficulty in breathing for some asthmatics. High concentrations of hydrogen sulphide (greater than 500 ppm) may cause loss of consciousness. The inhalation reference limit for hydrogen sulphide according to the Arizona Ambient Air Quality is $270\mu\text{g}/\text{m}^3$ for 24 hours exposure.
7	PM10	100.0 (24-hours average)	Malaysian Ambient Air Quality Standards 2013 (Standard 2020)	<ul style="list-style-type: none"> Particulate matters and total suspended solids are capable of provoking respiratory system irritation, with the release of mediators causing exacerbations of lung disease and increasing blood coagulability in susceptible individuals. This ultra-fine particulate with a mass median aerodynamic diameter less than 10 microns (PM_{10}) may mediate some of the adverse health effects reported in which there is toxicologic evidence to support this contention. The health effects for $\text{PM}_{2.5}$ is considered worst than PM_{10} in general since it's capable of entering the systemic circulation more easy. These particles are able to enhance calcium influx on contact with macrophages. Oxidative stress is also to be anticipated, which augmented by oxidants generated by recruiting inflammatory leukocytes producing atheromatous plaques form in the coronary arteries, which one of the causes of morbidity and death associated epidemiologically with particulate air pollution.
8	PM2.5	35 (24-hour average)	Malaysian Ambient Air Quality Standards 2013 (Standard 2020)	

	<p style="text-align: center;">ADDITIONAL INFORMATION TO THE DEIA REFINERY AND PETROCHEMICAL INTEGRATED DEVELOPMENT (RAPID) PROJECT, PENGERANG JOHOR, 2012 TO INCLUDE EURO 5 MOGAS AND OLEFIN TANK UNITS</p>	
	<p style="text-align: center;">CHAPTER 4 POTENTIAL ENVIRONMENTAL IMPACT AND MITIGATION MEASURES</p>	

4.3.2.4 FINDINGS

4.3.2.4.1 Existing Public Health Status

The existing Public Health Status is further described in **Volume 2, Appendix 2**.

4.3.2.4.2 Impacts From Operation



This section details the public health impact assessment of the air pollutant emission from the Cumulative Refinery & Cracker Complex and Cumulative RAPID Complex during the operation phase based on the findings from the Air Dispersion Modeling Study (**Volume 2, Appendix 1**).

4.3.2.4.2.1 Impact from emission from EURO 5 MOGAS Unit

a) Normal Operation Scenario

During this scenario, the EURO 5 MOGAS vent is routed to CHNT2 Unit to be treated before discharged to atmosphere. Data from the air dispersion modelling showed that:

- All sensitive receptors have hazard index (HI) of not more than one. These indicate that all locations are predicted to have a good ambient air quality during normal release from the EURO 5 MOGAS unit (**Table 4-24**).
- The maximum point for PM₁₀ is expected to occurred at Bukit Penggerang with concentration of 36.034 µg/m³. This give rise the HQ value of 0.4, which is not more than one. Therefore, in normal scenario, the new unit wont poses any significant health risk to all receptors.
- For PM_{2.5}, its maximum ground concentration is also predicted to happened at Bukit Penggerang with estimated incremental of 0.034 µg/m³. This give rise the HQ of less than one (0.001), which indicate

	<p align="center">ADDITIONAL INFORMATION TO THE DEIA REFINERY AND PETROCHEMICAL INTEGRATED DEVELOPMENT (RAPID) PROJECT, PENGERANG JOHOR, 2012 TO INCLUDE EURO 5 MOGAS AND OLEFIN TANK UNITS</p>	
	<p align="center">CHAPTER 4 POTENTIAL ENVIRONMENTAL IMPACT AND MITIGATION MEASURES</p>	

the unit is expected not to create any substantial health hazard to all surrounding receptors.

- Pertaining to SO₂ emission from the new unit, the highest point is expected also at the Bukit Penggerang with concentration of 1.1 µg/m³. The HQ is only 0.004 that indicate no significant health risk to all identified receptors.
- The highest concentration of NO₂ (tier-1) is also been predicted to occur at the Bukit Penggerang with the 30.8 µg/m³. This give the HQ of 0.1, which indicates of no significant health risk will be impose during normal operation of the new EURO 5 MOGAS unit.
- Specific on CO, its maximum point is predicted to be occurred at Bukit Penggerang with concentration of 101.1 µg/m³ that gives the value of HQ of 0.01. All receptors are free from any health risk of CO emission.



In summary, the new EURO 5 MOGAS unit is found to have no significant health impact to all receptors during normal operating condition.

b) Abnormal Operation Scenario

Emission from this unit during abnormal scenario is as per normal operating condition.

c) Emergency Operating Scenario

No emergency operating scenario modelling is done for this system as the waste gasses are flared and this is expected to be temporary less than 1 hour.

	<p style="text-align: center;">ADDITIONAL INFORMATION TO THE DEIA REFINERY AND PETROCHEMICAL INTEGRATED DEVELOPMENT (RAPID) PROJECT, PENGERANG JOHOR, 2012 TO INCLUDE EURO 5 MOGAS AND OLEFIN TANK UNITS</p>	
	<p style="text-align: center;">CHAPTER 4 POTENTIAL ENVIRONMENTAL IMPACT AND MITIGATION MEASURES</p>	

4.3.2.4.2.2 Impact from emission from the Olefin Storage Tanks

a) Normal Operation Scenario



No air dispersion modeling was done for the Olefin Storage Tanks since there is no continuous emission.

b) Abnormal Operation Scenario

Intermittent emission from Olefin storage tanks is routed to the Cold Flare located within the Olefin Storage Tank. In this scenario, only NO₂ (tier-1) and CO are being assessed and computed as other pollutants are not relevant.

- All sensitive receptors have hazard index (HI) of not more than one. These indicate that all receptors are predicted to have a clean and good quality of air during intermittent release from the Olefin Storage Tanks (**Table 4-25**).
- However, the maximum point for NO₂ (tier-1) is predicted to occur at RAPID complex with concentration of 308.1 µg/m³. This give the hazard quotient (HQ) of 1.1, which indicates of no significant health risk will be impose if abnormal operation occurred.
- Pertaining to CO, its maximum concentration is predicted to be at 1814.0 µg/m³ that gives the value of HQ of 0.1. The value means that during abnormal scenario, its predicted to have no substantial health risk.

In conclusion, for the Olefin Storage Tanks air emission have no significant health impact to all sensitive receptors and people working within RAPID complex itself during abnormal operating scenario.

	<p align="center">ADDITIONAL INFORMATION TO THE DEIA REFINERY AND PETROCHEMICAL INTEGRATED DEVELOPMENT (RAPID) PROJECT, PENGERANG JOHOR, 2012 TO INCLUDE EURO 5 MOGAS AND OLEFIN TANK UNITS</p>	
	<p align="center">CHAPTER 4 POTENTIAL ENVIRONMENTAL IMPACT AND MITIGATION MEASURES</p>	

c) Emergency Operating Scenario

No emergency operating scenario modelling is done for this system as the waste gasses are flared and this is expected to be temporary less than 1 hour.





Table 4-24: Predicted Concentration, Hazard Quotient and Hazard Index for the EURO 5 MOGAS Unit (Normal Operation Scenario) at Sensitive Receptor Locations

Location (Sensitive Receptors)	PM ₁₀ (24 hours average)		PM _{2.5} (24 hours average)		SO ₂ (1 hour average)		NO ₂ (Tier 1) (1 hour average)		CO (8 hours average)		Hazard Index
	Conc. (µg/m ³)	HQ	Conc. (µg/m ³)	HQ	Conc. (µg/m ³)	HQ	Conc. (µg/m ³)	HQ	Conc. (µg/m ³)	HQ	
Tg. Pengelih	24.0	0.24	0.0012	0.00003	5.0	0.07143	5.8	0.0232	100.0	0.01	0.3
Pengelih Naval Base	24.0	0.24	0.0339	0.00097	6.1	0.08714	30.8	0.1232	101.1	0.01011	0.5
Kg. Penggerang	36.0	0.36	0.0019	0.00005	5.1	0.07286	6.2	0.0248	100.1	0.01001	0.5
Kg. Sg. Kapal	25.0	0.25	0.0068	0.00019	5.1	0.07286	6.7	0.0268	100.1	0.01001	0.4
Taman Rengit Jaya	38.0	0.38	0.0050	0.00014	5.1	0.07286	7.0	0.028	100.1	0.01001	0.5
Kg. Sg. Buntu	28.0	0.28	0.0039	0.00011	5.1	0.07286	6.8	0.0272	100.1	0.01001	0.4
Kg. Bukit Buloh	31.0	0.31	0.0017	0.00004	5.1	0.07286	6.8	0.0272	100.0	0.01	0.4
Kg. Sg. Rengit	20.0	0.2	0.0014	0.00004	0.1	0.00143	1.6	0.0064	0.0	0.000	0.2
Kg. Bukit Gelugor	22.0	0.22	0.0015	0.00004	5.1	0.07286	6.6	0.0264	100.0	0.01	0.3
Kg. Lepau	35.0	0.35	0.0017	0.00005	5.1	0.07286	6.9	0.0276	100.1	0.01001	0.5
Kg. Pasir Gogok	20.0	0.20	0.0011	0.00003	0.0	0.00000	1.1	0.0044	0.0	0.00000	0.2

Table 4-25: Predicted Concentration, Hazard Quotient and Hazard Index for the Olefin Storage Tanks (Abnormal Operation Scenario) at Sensitive Receptor Locations

Location (Sensitive Receptors)	NO ₂ (Tier 1) (1 hour average)		CO (8 hours average)		Hazard Index
	Conc. (µg/m ³)	Hazard Quotient	Conc. (µg/m ³)	Hazard Quotient	
Tg. Pengelih	14.7	0.0	99.1	0.0	0.0
Pengelih Naval Base	133.7	0.5	714.3	0.0	0.5
Kg. Penggerang	17.0	0.1	112.1	0.0	0.1
Kg. Sg. Kapal	35.0	0.1	172.8	0.0	0.1
Taman Rengit Jaya	30.4	0.1	160.9	0.0	0.1
Kg. Sg. Buntu	26.5	0.1	132.1	0.0	0.1
Kg. Bukit Buloh	43.6	0.2	222.2	0.0	0.2
Kg. Sg. Rengit	16.2	0.1	111.3	0.0	0.1
Kg. Bukit Gelugor	18.5	0.1	87.7	0.0	0.1
Kg. Lepau	29.4	0.1	147.5	0.0	0.1
Kg. Pasir Gogok	14.1	0.0	84.8	0.0	0.0



	<p style="text-align: center;">ADDITIONAL INFORMATION TO THE DEIA REFINERY AND PETROCHEMICAL INTEGRATED DEVELOPMENT (RAPID) PROJECT, PENGERANG JOHOR, 2012 TO INCLUDE EURO 5 MOGAS AND OLEFIN TANK UNITS</p>	
	<p style="text-align: center;">CHAPTER 4 POTENTIAL ENVIRONMENTAL IMPACT AND MITIGATION MEASURES</p>	

4.3.2.4.2.3 Impact from Cumulative Refinery & Cracker Complex

a) Normal Operation Scenario

For this normal operation scenario, the available baseline concentrations were only for PM₁₀, SO₂, NO₂, and CO. Others are not detected during the baseline study. Therefore, for particular pollutants like NH₃, methanol, and H₂S, their respective maximum incremental limits were used as a proxy for their ground concentrations.

- As for the health risk characterisation, none of the receptors have hazard index (HI) of more than one (**Table 4-26**). This means that for this refinery cracker complex, the ambient air quality is predicted to pose a low risk to health and will not cause any excess of health problems among the exposed receptors or population.
- However, in assessing for the individual pollutants, the highest point of incremental of PM₁₀ is predicted to occur at Bukit Penggerang that's quite far away from those sensitive receptors. The maximum cumulative ground concentration is about 1.8 µg/m³ with a HQ value of 0.2 that not more than one. The condition itself is safe with low health risk.
- For SO₂, the highest point is within the RAPID complex of 90.5 µg/m³ that give rise to HQ value of 0.36, which it's health risk is not significant. All sensitive receptors are secured.
- For NO₂ (tier 3), the maximum predicted concentration is at Bukit Pelali with 479.5 µg/m³ predicted concentration. Its HQ is 1.7, which still not more than one indicating of no substantial health hazard. The hilly area is actually far away from any sensitive receptors in the study.
- For CO, it's maximum ground concentration is predicted to occur within the RAPID complex with a value of 204.8 µg/m³ that give HQ of 0.02, it is no significant health implication.



	<p style="text-align: center;">ADDITIONAL INFORMATION TO THE DEIA REFINERY AND PETROCHEMICAL INTEGRATED DEVELOPMENT (RAPID) PROJECT, PENGERANG JOHOR, 2012 TO INCLUDE EURO 5 MOGAS AND OLEFIN TANK UNITS</p>	
	<p style="text-align: center;">CHAPTER 4 POTENTIAL ENVIRONMENTAL IMPACT AND MITIGATION MEASURES</p>	

- Pertaining to NH₃, it is predicted to reach the maximum incremental limit of 0.302 µg/m³, also within RAPID complex. Its HQ is about 0.001, which significantly no excess of health hazard.
- For methanol, it is predicted to increase at the maximum limit up to 6.2 µg/m³ that found within RAPID complex. The HQ is 0.05, which is low risk of adverse health effects.
- The next pollutant is H₂S that predicted to have highest concentration of 0.907 µg/m³ that located within RAPID complex. Its HQ is 0.003, which has no significant health danger.

b) Abnormal Operation Scenario

This scenario is based on only one emission control failure event at a time or based on the worst-case pollutant load released from a selected failure event. Once more, most of the potential pollutants are not detected as for their baseline concentration except for SO₂ and NO₂. For other pollutants, their maximum incremental concentrations are applied to assess their health risk. Unburned hydrocarbon (UHC) is not being assessed as it's not risky to health. Pollutants like PM₁₀ and PM_{2.5} are not included since there is no standard for a 1-hour exposure. And methanol is not being modelled in this scenario.

- During abnormal operation, the waste gasses are released to the atmosphere and this is expected to be temporary, less than one hour for all parameters.
- All sensitive receptors within 0 to 5 km radius from the complex are predicted to have the HI of more than one in this abnormal scenario (**Table 4-27**). It means the ambient air is polluted and not safe for all receptors. However, it's only temporarily and less for one hour.
- Among those sensitive receptors, the highest risk area in this condition is the Pengelih Naval Base with HI of 70.5 mainly due to emission of SO₂. However, for this to occur is very unlikely because of other emission control that's available to take care the load released. Its for the short time that less than one hour.



	ADDITIONAL INFORMATION TO THE DEIA REFINERY AND PETROCHEMICAL INTEGRATED DEVELOPMENT (RAPID) PROJECT, PENGERANG JOHOR, 2012 TO INCLUDE EURO 5 MOGAS AND OLEFIN TANK UNITS	
	CHAPTER 4 POTENTIAL ENVIRONMENTAL IMPACT AND MITIGATION MEASURES	

- On the other hand, looking at individual pollutants, most of them concentrated within RAPID complex itself. The highest point for SO₂ is within RAPID complex itself, with 40582.8 µg/m³ that give HQ of 162.33. It is a very hazardous condition that required prompt use of respirators if happened. Without any personal protective equipments, a person may develop respiratory problem and trouble in breathing after 10 minutes of exposure. Again, this is expected to be temporary that less than one hour. With good wind blow and dilution, the pollutant is no more at dangerous concentration.
- For NO₂, the highest point is also within the RAPID complex with concentration of 2073.8 µg/m³. The HQ for this point is 7.4, which very hazardous to human being. At this concentration, workers without any respirator may develop sneezing, shortness of breath and coughing after 2-hour exposure. However, from the modelling result, its occurrence is predicted only at the 0.5 percentile, which the probability to occur is only nine days in every five years of operating period.
- Again RAPID complex is predicted to have the highest concentration point for CO with 1814.0 µg/m³ (HQ of 0.1). Nevertheless, it is safe and predicted not to induce any substantial health problems.
- And for H₂S, the highest level is also predicted to be inside RAPID complex with concentration of 456.1 µg/m³ and HQ of 1.7, which is unhealthy and may cause respiratory problems among exposed person.

In conclusion, in this abnormal operating scenario, all identified sensitive receptors are exposed to high health risk mainly due to high emission of SO₂. It may trigger sudden sneezing, difficulty in breathing and chest discomfort. However, it is predicted not to claim any fatality cases since its only temporarily and less than one hour.

c) Emergency Operation Scenario

For the emergency operation scenario, most of the pollutants are not detected as for their baseline concentrations except for SO₂ and NO₂.

	<p>ADDITIONAL INFORMATION TO THE DEIA REFINERY AND PETROCHEMICAL INTEGRATED DEVELOPMENT (RAPID) PROJECT, PENERANG JOHOR, 2012 TO INCLUDE EURO 5 MOGAS AND OLEFIN TANK UNITS</p>	
	<p>CHAPTER 4 POTENTIAL ENVIRONMENTAL IMPACT AND MITIGATION MEASURES</p>	

Since there is no standard limit for 1-hour PM₁₀ and PM_{2.5}, both are not being assessed in this scenario. Similarly for NH₃ and methanol because they are not being modelled in this exercise.

- The modelling results showed that none of the sensitive receptors have hazard index (HI) of more than one (**Table 4-28**). All identified receptors are not exposed to any health risk due to the emission.
- Most of the predicted pollutants are found to be concentrated at the ocean, south of the RAPID complex site, but at lower concentrations that far below the allowable limits.
- For SO₂, its maximum incremental of 120.4 µg/m³ gave rise to the value of 0.5 HQ. The situation is safe and no significant risk to health.
- For NO₂, its maximum incremental value of 9.3 µg/m³ is equivalent with 0.03 HQ. The circumstance causes no substantial danger to health.
- And for CO, the maximum incremental of 50.7 µg/m³ that equal to HQ of 0.002. The condition is very safe with low risk of hazard to receptors.
- For H₂S, the highest level was 1.3 µg/m³ that give HQ value of 0.02.

In general, for the emergency operations scenario, the Refinery Cracker Complex is predicted not to create any extra health adverse effects in the exposed communities surrounding the proposed project site.



Table 4-26: Predicted Concentration, Hazard Quotient and Hazard Index for Cumulative Refinery & Cracker Complex (Normal Operation Scenario) at Sensitive Receptor Locations

Location (Sensitive Receptors)	PM ₁₀ (24 hours average)		PM _{2.5} (24 hours average)		SO ₂ (1 hour average)		NO ₂ (Tier 3) (1 hour average)		CO (8 hours average)		NH ₃ (24 hours average)		Methanol (24 hours average)		H ₂ S (24 hours average)		Hazard Index
	Conc. (µg/m ³)	Hazard Quotient	Conc. (µg/m ³)	Hazard Quotient	Conc. (µg/m ³)	Hazard Quotient	Conc. (µg/m ³)	Hazard Quotient	Conc. (µg/m ³)	Hazard Quotient	Conc. (µg/m ³)	Hazard Quotient	Conc. (µg/m ³)	Hazard Quotient	Conc. (µg/m ³)	Hazard Quotient	
Tg. Pengelih	24.2	0.2	0.1	0.0	21.5	0.1	19.1	0.1	109.6	0.0	0.0	0.0	0.2	0.0	0.1	0.0	0.4
Pengelih Naval Base	24.4	0.2	0.3	0.0	34.8	0.1	116.4	0.4	125.9	0.0	0.0	0.0	0.0	0.0	0.1	0.0	0.8
Kg. Penggerang	36.2	0.4	0.2	0.0	22.6	0.1	25.4	0.1	108.5	0.0	0.0	0.0	0.2	0.0	0.1	0.0	0.6
Kg. Sg. Kapal	25.4	0.3	0.2	0.0	53.7	0.2	83.4	0.3	121.4	0.0	0.0	0.0	0.6	0.0	0.2	0.0	0.8
Taman Rengit Jaya	38.4	0.4	0.3	0.0	39.1	0.2	75.4	0.3	141.5	0.0	0.0	0.0	0.9	0.0	0.1	0.0	0.9
Kg. Sg. Buntu	28.4	0.3	0.2	0.0	28.9	0.1	67.3	0.2	120.6	0.0	0.0	0.0	0.4	0.0	0.1	0.0	0.6
Kg. Bukit Buloh	31.4	0.3	0.2	0.0	47	0.2	96.5	0.3	304.8	0.0	0.2	0.0	3.8	0.0	0.2	0.0	0.8
Kg. Sg. Rengit	20.3	0.2	0.2	0.0	30.4	0.1	68	0.2	11.5	0.0	0.0	0.0	0.1	0.0	0.1	0.0	0.5
Kg. Bukit Gelugor	22.2	0.2	0.1	0.0	33	0.1	68.5	0.2	109.9	0.0	0.0	0.0	0.1	0.0	0.1	0.0	0.5
Kg. Lepau	35.4	0.4	0.3	0.0	51	0.2	72.9	0.3	122.3	0.0	0.0	0.0	0.2	0.0	0.3	0.0	0.8
Kg. Pasir Gogok	20.3	0.2	0.2	0.0	20.5	0.1	31.9	0.1	10.6	0.0	0.0	0.0	0.2	0.0	0.1	0.0	0.4



Table 4-27: Predicted Cumulative GLC, Hazard Quotient and Hazard Index for Cumulative Refinery & Cracker Complex (Abnormal Operation Scenario) at Sensitive Receptor Locations

Location (Sensitive Receptors)	SO ₂ (1 hour average)		NO ₂ (1 hour average)		CO (1 hours average)		H ₂ S (1 hour average)		Hazard Index
	Conc. (µg/m ³)	Hazard Quotient	Conc. (µg/m ³)	Hazard Quotient	Conc. (µg/m ³)	Hazard Quotient	Conc. (µg/m ³)	Hazard Quotient	
Tg. Pengelih	1303.9	5.2	86.6	0.3	99.1	0.0	24.5	0.1	5.6
Pengelih Naval Base	16625.7	66.5	928.3	3.3	714.3	0.0	182.3	0.7	70.5
Kg. Penggerang	1547.3	6.2	95.4	0.3	112.1	0.0	31.3	0.1	6.6
Kg. Sg. Kapal	3745.9	15.0	213.6	0.8	172.8	0.0	45.8	0.2	16.5
Taman Rengit Jaya	3441.2	13.8	192.7	0.7	160.9	0.0	50.1	0.2	14.7
Kg. Sg. Buntu	2870	11.5	162.1	0.6	132.1	0.0	39.9	0.1	12.2
Kg. Bukit Buloh	5402.5	21.6	300.3	1.1	222.2	0.0	62.8	0.2	22.9
Kg. Sg. Rengit	2051.7	8.2	118.8	0.4	111.3	0.0	29.1	0.1	8.7
Kg. Bukit Gelugor	1705.7	6.8	117.3	0.4	87.7	0.0	22.1	0.1	7.3
Kg. Lepau	3061.3	12.2	175.2	0.6	147.5	0.0	38.4	0.1	12.9
Kg. Pasir Gogok	1890.4	7.6	106.8	0.4	84.8	0.0	22.0	0.1	8.1



Table 4-28: Predicted Concentration, Hazard Quotient and Hazard Index for Cumulative Refinery & Cracker Complex (Emergency Operation Scenario) at Sensitive Receptor Locations

Location (Sensitive Receptors)	SO ₂ (1 hour average)		NO ₂ (1 hour average)		CO (1 hour average)		H ₂ S (1 hour average)		Hazard Index
	Conc. (µg/m ³)	Hazard Quotient	Conc. (µg/m ³)	Hazard Quotient	Conc. (µg/m ³)	Hazard Quotient	Conc. (µg/m ³)	Hazard Quotient	
Tg. Pengelih	96.1	0.4	12.1	0.0	38.4	0.0	1.0	0.0	0.4
Pengelih Naval Base	104.7	0.4	12.7	0.0	42	0.0	1.1	0.0	0.4
Kg. Penggerang	85.0	0.3	11.2	0.0	33.7	0.0	0.9	0.0	0.3
Kg. Sg. Kapal	104.3	0.4	12.7	0.0	41.8	0.0	1.1	0.0	0.4
Taman Rengit Jaya	97.2	0.4	12.1	0.0	38.9	0.0	1.0	0.0	0.4
Kg. Sg. Buntu	89.7	0.4	11.6	0.0	35.7	0.0	0.9	0.0	0.4
Kg. Bukit Buloh	100.5	0.4	12.4	0.0	40.3	0.0	1.0	0.0	0.4
Kg. Sg. Rengit	103.3	0.4	8.0	0.0	43.5	0.0	1.1	0.0	0.4
Kg. Bukit Gelugor	111.5	0.4	13.2	0.0	44.9	0.0	1.2	0.0	0.4
Kg. Lepau	98.8	0.4	12.3	0.0	39.5	0.0	1.0	0.0	0.4
Kg. Pasir Gogok	104.1	0.4	8.1	0.0	43.8	0.0	1.1	0.0	0.4

	ADDITIONAL INFORMATION TO THE DEIA REFINERY AND PETROCHEMICAL INTEGRATED DEVELOPMENT (RAPID) PROJECT, PENGERANG JOHOR, 2012 TO INCLUDE EURO 5 MOGAS AND OLEFIN TANK UNITS	
	CHAPTER 4 POTENTIAL ENVIRONMENTAL IMPACT AND MITIGATION MEASURES	



4.3.2.4.2.4

Impact from Cumulative RAPID Complex

a) Normal Operation Scenario

The predicted concentration of identified pollutants for Cumulative RAPID Complex during this normal operation scenario and their hazard quotient and hazard index are shown in **Table 4-29**. The baseline concentrations for PM_{2.5}, methanol, NH₃, and H₂S are not detected. Thus, their maximum incremental concentrations are applied to calculate their risks.

- For this normal operation scenario, none of the sensitive receptors around the proposed project area have the HI of more than one. All locations are predicted to have clean and safe ambient air without any significant potential of health effects due to exposure among the receptors.
- For PM₁₀, the highest point was at Bukit Penggerang with maximum increments of only 3.2 µg/m³ concentration. The location is clean and has low health risk with HQ of 0.03.
- For SO₂, the highest concentration was within the RAPID complex itself, with maximum incremental of 91.0 µg/m³ that gave the HQ value of 0.4, which is also clean with insignificant health risk.
- For NO₂, the most concentrated point by air dispersion modelling was at Bukit Pelali with maximum incremental value of 523.0 µg/m³ that equivalent to 1.87 points of HQ. The condition is unhealthy especially among asthmatic patients and lung diseases like chronic bronchitis. Fortunately, the area is a hilly area with no regular inhabitant. Nevertheless, from the modelling, its occurrence is predicted approximately 0.5 percentile, which the probability to occur is only nine days in every five years of operating period.

	ADDITIONAL INFORMATION TO THE DEIA REFINERY AND PETROCHEMICAL INTEGRATED DEVELOPMENT (RAPID) PROJECT, PENERANG JOHOR, 2012 TO INCLUDE EURO 5 MOGAS AND OLEFIN TANK UNITS	
	CHAPTER 4 POTENTIAL ENVIRONMENTAL IMPACT AND MITIGATION MEASURES	



- And as for CO, the highest point with maximum incremental concentration of 205.0 $\mu\text{g}/\text{m}^3$ that detected within RAPID complex itself. The HQ is 0.02 only, which indicates clean air quality without any substantial health danger.
- The maximum incremental concentration of NH_3 is predicted to occur within the RAPID complex with a value of 0.3 $\mu\text{g}/\text{m}^3$ that give HQ of 0.001, which safe and no health risk.
- The high point for methanol is also within the RAPID complex (6.2 $\mu\text{g}/\text{m}^3 = \text{HQ of } 0.05$). The point is spare from any health risk.
- For H_2S , the highest level was 0.907 $\mu\text{g}/\text{m}^3$ within RAPID complex that give HQ value of 0.003. Again, it's safe and no risk to health.

These bring a conclusion that during normal operation of the proposed project as a cumulative effect with other units, there won't be any extra or excess of health risks toward the identified sensitive receptors. Only a spot of high concentration of NO_2 is predicted to occur at Bukit Pelali, which is predicted to occur only nine days in five years of operation. In summation, the region is actually a hill and its not an attractive site to be seen by anybody.

b) Abnormal Operation Scenario

In this scenario, most of the potential pollutants don't have their baseline concentration except for SO_2 and NO_2 (**Table 4-30**). Unburned hydrocarbon (UHC) is not being assessed as it's not risky to health. Pollutants like PM_{10} and $\text{PM}_{2.5}$ are not included since there is no standard for a 1-hour exposure. And methanol is not being modelled in this scenario.



- During abnormal operation of Refinery Cracker Complex, the waste gasses are released to the atmosphere and this is expected to be

	<p style="text-align: center;">ADDITIONAL INFORMATION TO THE DEIA REFINERY AND PETROCHEMICAL INTEGRATED DEVELOPMENT (RAPID) PROJECT, PENGERANG JOHOR, 2012 TO INCLUDE EURO 5 MOGAS AND OLEFIN TANK UNITS</p>	
	<p style="text-align: center;">CHAPTER 4 POTENTIAL ENVIRONMENTAL IMPACT AND MITIGATION MEASURES</p>	

temporary, thus the modelling shall be modelled for 1 hour averaging time for all parameters.

- All identified sensitive receptors within 5 kilometre radius from RAPID complex boundaries have HI of more than one. The highest is the Pengelih Naval Base (HI of 71.5). Fortunately, it is very unlikely because of other emission control systems in Rapid Complex that available to take care the temporarily stack release within one hour.
- The highest point for SO₂ is within RAPID complex itself, with 40582.8 µg/m³ that give HQ of 162.33, which is a very hazardous that required the use of respirators. However, it won't cause any fatality since the value is far below than the limit set by NIOSH (262,000 µg/m³) as the immediately dangerous to life or health (IDLH). In addition, its only temporary and less than one hour.
- For NO₂, the highest point is also within the RAPID complex with concentration of 2073.8 µg/m³. The HQ for this point is 7.4, which very hazardous to human being. At this concentration, anybody healthy without any PPEs may develop respiratory problems like shortness of breath and coughing only after 2-hour of exposure. However, from the modelling results, the occurrence is very low as predicted, to happen in nine days within five years of operation. On the other hand, the value is very low compared to the IDHL for NO₂ (190,000 µg/m³).
- For CO, the highest point with maximum incremental concentration of 1814.1 µg/m³ that detected within RAPID complex itself. The HQ is 0.06, which is clean and no significant health risk.
- For H₂S, the highest level was 456.1 µg/m³ within RAPID complex that give HQ value of 1.7, which is not healthy and poses significant risk to site workers' health.

In conclusion, the abnormal operation of the proposed project is predicted to pose a significant health effect to the workers within RAPID complex itself.

	<p style="text-align: center;">ADDITIONAL INFORMATION TO THE DEIA REFINERY AND PETROCHEMICAL INTEGRATED DEVELOPMENT (RAPID) PROJECT, PENGERANG JOHOR, 2012 TO INCLUDE EURO 5 MOGAS AND OLEFIN TANK UNITS</p>	
	<p style="text-align: center;">CHAPTER 4 POTENTIAL ENVIRONMENTAL IMPACT AND MITIGATION MEASURES</p>	

c) Emergency Operation Scenario

Once more, most of the pollutants for this modelling exercise don't have their baseline concentrations except for both SO₂ and NO₂ (**Table 4-31**). However, the maximum incremental concentrations are used to predict the health risks for other pollutants like CO, and H₂S. There is no limit for 1-hour PM₁₀ and PM_{2.5}. Thus, both of the parameters are not being appraised in the study. There is also no prediction for NH₃ and methanol in this scenario. During this emergency operation, the waste gasses are flared. The health impact is expected to be minimal and temporary that less than 1 hour of exposure.

- In this circumstance, none of sensitive receptors have the HI of more than one. All locations are predicted to have clean and safe air during this scenario without any potential of health risk among receptors.
- For SO₂, the highest concentration is predicted to be at the ocean, south of the RAPID complex with maximum incremental of 120.5 µg/m³ that gave the HQ value of 0.48. The HQ indicates no excess of health risk at the location due to SO₂.
- For NO₂, the highest incremental point was at Bukit Penggerang with a value of 165.0 µg/m³ that equivalent to value of HQ of 0.59. Again, the location has no substantial health hazard due to NO₂ exposure.
- And for CO, the highest point with maximum incremental concentration of 546.4 µg/m³ that detected at Bukit Penggerang. The HQ is 0.02, which indicates of no present of health hazard at the location.
- For H₂S, the highest point was 1.3 µg/m³ detected at the ocean, south of the RAPID complex that give HQ value of 0.02. The point has low health risk.

In conclusion, in this emergency operation scenario of the proposed cumulative RAPID complex project, it doesn't pose any significant health effect to all sensitive receptors.



Table 4-29: Predicted Concentration, Hazard Quotient and Hazard Index for Cumulative RAPID Complex (Normal Operation Scenario) at Sensitive Receptor Locations

Location (Sensitive Receptors)	PM ₁₀ (24 hours average)		PM _{2.5} (24 hours average)		SO ₂ (1 hour average)		NO ₂ (Tier 3) (1 hour average)		CO (8 hours average)		NH ₃ (24 hours average)		Methanol (24 hours average)		H ₂ S (24 hours average)		Hazard Index
	Conc. (µg/m ³)	Hazard Quotient	Conc. (µg/m ³)	Hazard Quotient	Conc. (µg/m ³)	Hazard Quotient	Conc. (µg/m ³)	Hazard Quotient	Conc. (µg/m ³)	Hazard Quotient	Conc. (µg/m ³)	Hazard Quotient	Conc. (µg/m ³)	Hazard Quotient	Conc. (µg/m ³)	Hazard Quotient	
Tg. Pengelih	24.3	0.2	0.2	0.0	22.0	0.1	23.3	0.1	109.6	0.0	0.0	0.0	0.2	0.0	0.1	0.0	0.4
Pengelih Naval Base	26.4	0.3	1.5	0.0	34.8	0.1	180.2	0.6	125.9	0.0	0.0	0.0	0.0	0.0	0.1	0.0	1.1
Kg. Penggerang	36.5	0.4	0.3	0.0	23.1	0.1	29.8	0.1	108.5	0.0	0.0	0.0	0.2	0.0	0.1	0.0	0.6
Kg. Sg. Kapal	25.5	0.3	0.4	0.0	54.6	0.2	91.3	0.3	121.4	0.0	0.0	0.0	0.6	0.0	0.2	0.0	0.8
Taman Rengit Jaya	38.5	0.4	0.4	0.0	39.7	0.2	82.1	0.3	141.5	0.0	0.0	0.0	0.9	0.0	0.1	0.0	0.9
Kg. Sg. Buntu	28.5	0.3	0.3	0.0	29.2	0.1	76.0	0.3	120.6	0.0	0.0	0.0	0.4	0.0	0.1	0.0	0.7
Kg. Bukit Buloh	31.5	0.3	0.3	0.0	47.6	0.2	105.0	0.4	304.8	0.0	0.2	0.0	3.8	0.0	0.2	0.0	0.9
Kg. Sg. Rengit	20.4	0.2	0.3	0.0	30.9	0.1	77.1	0.3	11.5	0.0	0.0	0.0	0.1	0.0	0.1	0.0	0.6
Kg. Bukit Gelugor	22.4	0.2	0.2	0.0	33.5	0.1	80.2	0.3	109.9	0.0	0.0	0.0	0.1	0.0	0.1	0.0	0.7
Kg. Lepau	35.7	0.4	0.6	0.0	51.4	0.2	77.7	0.3	122.3	0.0	0.0	0.0	0.2	0.0	0.3	0.0	0.8
Kg. Pasir Gogok	20.4	0.2	0.3	0.0	21.0	0.1	41.0	0.1	10.6	0.0	0.0	0.0	0.2	0.0	0.1	0.0	0.4





Table 4-30: Predicted Concentration, Hazard Quotient and Hazard Index for Cumulative RAPID Complex (Abnormal Operation Scenario) at Sensitive Receptor Locations

Location (Sensitive Receptors)	SO ₂ (1 hour average)		NO ₂ (1 hour average)		CO (1 hours average)		H ₂ S (1 hour average)		Hazard Index
	Conc. (µg/m ³)	Hazard Quotient	Conc. (µg/m ³)	Hazard Quotient	Conc. (µg/m ³)	Hazard Quotient	Conc. (µg/m ³)	Hazard Quotient	
Tg. Pengelih	1303.9	5.2	92.2	0.3	99.5	0.0	24.5	0.1	5.6
Pengelih Naval Base	16626	66.5	936.0	3.3	744.4	0.0	182.3	0.7	71.5
Kg. Penggerang	1547.3	6.2	99.9	0.4	112.1	0.0	31.3	0.1	6.7
Kg. Sg. Kapal	3745.9	15.0	213.7	0.8	174.5	0.0	45.8	0.2	16.0
Taman Rengit Jaya	3441.2	13.8	193.0	0.7	160.9	0.0	50.1	0.2	14.7
Kg. Sg. Buntu	2870	11.5	163.5	0.6	142.3	0.0	39.9	0.1	12.2
Kg. Bukit Buloh	5402.5	21.6	300.3	1.1	455.6	0.0	62.8	0.2	22.9
Kg. Sg. Rengit	2051.7	8.2	126.7	0.5	111.3	0.0	29.1	0.1	8.8
Kg. Bukit Gelugor	1705.7	6.8	126.0	0.5	93.5	0.0	22.1	0.1	7.3
Kg. Lepau	3061.3	12.2	180.8	0.6	184.9	0.0	38.4	0.1	12.9
Kg. Pasir Gogok	1890.4	7.6	112.1	0.4	107.1	0.0	22.0	0.1	8.1



Table 4-31: Predicted Concentration, Hazard Quotient and Hazard Index for Cumulative RAPID Complex (Emergency Operation Scenario) at Sensitive Receptor Locations

Location (Sensitive Receptors)	SO ₂ (1 hour average)		NO ₂ (1 hour average)		CO (1 hour average)		H ₂ S (1 hour average)		Hazard Index
	Conc. (µg/m ³)	Hazard Quotient	Conc. (µg/m ³)	Hazard Quotient	Conc. (µg/m ³)	Hazard Quotient	Conc. (µg/m ³)	Hazard Quotient	
Tg. Pengelih	96.2	0.4	20.7	0.1	42.7	0.0	1.0	0.0	0.5
Pengelih Naval Base	104.8	0.4	170.0	0.6	546.4	0.0	1.1	0.0	1.0
Kg. Penggerang	85.1	0.3	22.0	0.1	47.3	0.0	0.9	0.0	0.4
Kg. Sg. Kapal	104.5	0.4	23.1	0.1	57.7	0.0	1.1	0.0	0.5
Taman Rengit Jaya	97.4	0.4	24.8	0.1	65.8	0.0	1.0	0.0	0.5
Kg. Sg. Buntu	89.8	0.4	21.2	0.1	52.3	0.0	0.9	0.0	0.5
Kg. Bukit Buloh	100.6	0.4	25.3	0.1	53.2	0.0	1.0	0.0	0.5
Kg. Sg. Rengit	103.5	0.4	19.4	0.1	49.8	0.0	1.1	0.0	0.5
Kg. Bukit Gelugor	111.7	0.4	26.0	0.1	51.3	0.0	1.2	0.0	0.5
Kg. Lepau	99.1	0.4	29.5	0.1	82.4	0.0	1.0	0.0	0.5
Kg. Pasir Gogok	104.2	0.4	15.8	0.1	50.1	0.0	1.1	0.0	0.5

	<p>ADDITIONAL INFORMATION TO THE DEIA REFINERY AND PETROCHEMICAL INTEGRATED DEVELOPMENT (RAPID) PROJECT, PENERANG JOHOR, 2012 TO INCLUDE EURO 5 MOGAS AND OLEFIN TANK UNITS</p>	
	<p>CHAPTER 4 POTENTIAL ENVIRONMENTAL IMPACT AND MITIGATION MEASURES</p>	

4.3.2.5 MITIGATION MEASURES



During the construction phase

- a) Potential of communicable and non-communicable diseases

From the existing health status of the communities surrounding the proposed project site, the area is found to have a significant burden of diseases like acute respiratory infection, tuberculosis, dengue fever, leptospirosis, food poisoning, sexually transmitted infections and road traffic accidents. The influx of workers (both foreign and local) may worsen the current health condition.



The proposed mitigation measures are as follows:

- **Workers' health monitoring**
 - i. Any workers with health symptoms such as chronic cough, fever, headache, chest discomfort or eye redness should be brought to a medical attention for further investigation and treatment. Anyone with chronic cough more than two weeks and bloody sputum, should be quarantined and investigated for pulmonary tuberculosis. All contacts among his college should be screen if he found to be positive with tuberculosis. Any positive cases should be notified to the Kota Tinggi health office as required by the law.
 - ii. Regularly, each worker is required to undergo medical check-up to detect any possibility of sexually transmitted infections (STIs). Anybody with symptoms like penile discharge or pain must be screened and treated for STIs accordingly.

	<p align="center">ADDITIONAL INFORMATION TO THE DEIA REFINERY AND PETROCHEMICAL INTEGRATED DEVELOPMENT (RAPID) PROJECT, PENGERANG JOHOR, 2012 TO INCLUDE EURO 5 MOGAS AND OLEFIN TANK UNITS</p>	
	<p align="center">CHAPTER 4 POTENTIAL ENVIRONMENTAL IMPACT AND MITIGATION MEASURES</p>	

- **Sanitation monitoring**
 - i. Proper housekeeping and good sanitation of the project site is important to be maintained all time. Any base camp should not crowded, have a good and effective ventilation system, clean toilets, and canteen. The camp should have a good solid waste system with regular collection by the authority or appointed agency. No empty containers that have a potential to collect water should be discarded or buried. Leftover foods should be collected in a container or plastic bag for disposal with other solid wastes.
 - ii. No open burning should be allowed and no open ground type of disposal for any waste. Regular inspection by the workers themselves should be scheduled accordingly to detect and destroy any potential breeding sites.

- **Prevention of food poisoning**
 - i. In order to prevent any food poisoning occurrence among workers, especially those staying in the camp, all food handlers should be vaccinated with typhoid vaccine regularly, and should have clean and hygiene body conditions.
 - ii. Any canteen or cooking area should be built in an area or space that far away from toilet or waste collection sites. There should be no storage room for raw foods, especially for those temporary base camps. All cooked food should be eaten immediately and no overnight foods should be taken in the early morning.

	<p align="center">ADDITIONAL INFORMATION TO THE DEIA REFINERY AND PETROCHEMICAL INTEGRATED DEVELOPMENT (RAPID) PROJECT, PENGERANG JOHOR, 2012 TO INCLUDE EURO 5 MOGAS AND OLEFIN TANK UNITS</p>	
	<p align="center">CHAPTER 4 POTENTIAL ENVIRONMENTAL IMPACT AND MITIGATION MEASURES</p>	



- **Reduction of road traffic accident**
 - i. No workers are allowed to drive any vehicle, except for those with a valid international license. They should attend a regular briefing on safe driving and road safety with exposure to local laws and cultures.
 - ii. All vehicles provided are only for work related tasks and should be maintained regularly at selected approved workshops.

During operation phase

- a) Potential of communicable diseases due to unmanage housekeeping and sanitation of the environment.

The proposed mitigation measures are as follows:

- **Reduction of breeding sites**
 - i. Regular surveillance and monitoring of the ground for any potential of vector breeding sites by workers and inspectorate appointed.
 - ii. All potential breeding sites should be covered from rainwater collection, or demolished.
- **Reduction of vector attraction factors**
 - i. All wastes, especially food based should be collected in a covered bin and disposed accordingly.
 - ii. All solid wastes should be picked up and disposed accordingly by the appointed waste collector.



	<p style="text-align: center;">ADDITIONAL INFORMATION TO THE DEIA REFINERY AND PETROCHEMICAL INTEGRATED DEVELOPMENT (RAPID) PROJECT, PENGERANG JOHOR, 2012 TO INCLUDE EURO 5 MOGAS AND OLEFIN TANK UNITS</p>	
	<p style="text-align: center;">CHAPTER 4 POTENTIAL ENVIRONMENTAL IMPACT AND MITIGATION MEASURES</p>	

b) Potential of health risks due to poor air quality

From the risk characterisation, the cumulative Refinery & Cracker Complex is predicted to cause poor air quality in abnormal operating scenario. Pertaining to cumulative RAPID complex, it's found to cause air pollution during the abnormal operating scenario. For emergency scenario, both Refinery & Cracker Complex and RAPID complex are predicted not to have any health impact.

The proposed health mitigation measures are as follows:

- **Awareness and education programs among community members.**
 - i. To ensure that individuals, communities, and agencies are familiar with their roles and responsibilities during normal, abnormal or emergency situation. It's beneficial for those involved as first responders to feel competent and comfortable with their roles, especially for health care workers and fire and rescue department. These also include their roles in giving advices about PPE, when to stay indoor and what is a good ventilation of a house for community members.
- **Continuous monitoring for air quality.**
 - i. To have an installation of indoor gas monitoring for at least three important pollutants, i.e. NO₂, SO₂ and H₂S within RAPID complex. All workers should wear their respirator once the siren is heard. Health and safety officer should continue monitoring the health of workers together in ensuring a good air exchange rate and ventilation at the site.

	<p>ADDITIONAL INFORMATION TO THE DEIA REFINERY AND PETROCHEMICAL INTEGRATED DEVELOPMENT (RAPID) PROJECT, PENERANG JOHOR, 2012 TO INCLUDE EURO 5 MOGAS AND OLEFIN TANK UNITS</p>	
	<p>CHAPTER 4 POTENTIAL ENVIRONMENTAL IMPACT AND MITIGATION MEASURES</p>	



- ii. To installed few gas detectors at the nearest sensitive communities, particularly the Pengelih Naval Base. With the cooperation of the Naval Base Rumah Sakit Angkatan Tentera (RSAT), the cases of respiratory illnesses should be monitored. Any incremental trend should be informed to the Kota Tinggi Health Office

- **Emergency Management Plan**

- i. The release should not exceed more than 30 minutes, if it's occurred. The proposed plant should have an emergency system to stop the plant to continue emitting SO₂ and NO₂ into the ambient air. This should be monitored by the proposed plant Emergency Management Coordinator under supervision of a council or company board.

- **Emergency Planning Committee.**

- i. May comprise of Plant Emergency Management Coordinator, representatives from the Municipal department, Fire and Rescue department, Health office, and police. These agencies could be called upon for planning and programs related or during an emergency to advise and assist the Committee.

	<p style="text-align: center;">ADDITIONAL INFORMATION TO THE DEIA REFINERY AND PETROCHEMICAL INTEGRATED DEVELOPMENT (RAPID) PROJECT, PENGERANG JOHOR, 2012 TO INCLUDE EURO 5 MOGAS AND OLEFIN TANK UNITS</p>	
	<p style="text-align: center;">CHAPTER 4 POTENTIAL ENVIRONMENTAL IMPACT AND MITIGATION MEASURES</p>	

4.3.3 NOISE DISSIPATION MODELING

4.3.3.1 Introduction

The objective of the Noise Dissipation Modeling was to establish and assess likely noise propagated from the New EURO 5 MOGAS Units and Additional Olefins Storage Tanks. The detailed study is provided in **Volume 2, Appendix 4**.



4.3.3.2 Study Approach and Methodology

The technical approach of the noise dissipation study involved the following:

- Separate noise models representing the different individual process units with its respective equipment and processes were used to determine noise propagation of the individual process units.
- A cumulative noise model representing all process units with all equipment of the combined process units was used to compute the cumulative noise of the entire Refinery & Cracker Complex as well as RAPID Complex.

The scenarios that will be considered for the purpose of the noise modelling are as follows:

- a) Scenarios for “Normal” operations that will be modelled as follow:
 - Individual Process units operating on its own Combined Process Unit (all 5 processes) operating simultaneously; and
 - Combined Process Units above repeated with worst case prevailing wind condition.
- b) “Abnormal” conditions for the Combined Process Units scenario with flaring (emergency requiring the utilization of the flare stack).

	<p style="text-align: center;">ADDITIONAL INFORMATION TO THE DEIA REFINERY AND PETROCHEMICAL INTEGRATED DEVELOPMENT (RAPID) PROJECT, PENGERANG JOHOR, 2012 TO INCLUDE EURO 5 MOGAS AND OLEFIN TANK UNITS</p>	
	<p style="text-align: center;">CHAPTER 4 POTENTIAL ENVIRONMENTAL IMPACT AND MITIGATION MEASURES</p>	

Further details of study approach and methodology is described in **Volume 1, Chapter 3.**

4.3.3.2.1 Applicable Regulatory Framework

Permissible Noise Level/Limit at RAPID Boundary and Sensitive Noise Recipient at its surrounding shall be established in reference to the approved Overall RAPID DEIA, 2012 Approval Limit (from first and revised approval) and also “Planning Guidelines for Environmental Noise Limit and Control”, published by Department of Environment Malaysia (2007).



A review will be made on Baseline Noise Level measured at nearest Sensitive Recipient (which will remain around the RAPID Boundary) to determine whether it meets the limits as in the condition of approval for the approved Overall RAPID DEIA, 2012.

Further details of the applicable regulatory framework is described in **Volume 1, Chapter 3.**

4.3.3.3 Modeling Data Input

4.3.3.3.1 Noise Sources

Noise sources were typically process equipment and process lines of the respective process units. The noise sources were extracted from the Equipment Lists that were established in the Front End Engineering & Design (FEED) of the respective process units. The Equipment List and assumed sound emission levels of the respective equipment are given in the Schedule of Equipment and Noise Data Table appended **Volume 2, Sub-Appendices 4A.**

	ADDITIONAL INFORMATION TO THE DEIA REFINERY AND PETROCHEMICAL INTEGRATED DEVELOPMENT (RAPID) PROJECT, PENGERANG JOHOR, 2012 TO INCLUDE EURO 5 MOGAS AND OLEFIN TANK UNITS	
	CHAPTER 4 POTENTIAL ENVIRONMENTAL IMPACT AND MITIGATION MEASURES	

Equipment noise for the RAPID Complex was specified in Project Specification-Equipment Noise Specification. These specifications stipulated the followings :

- Maximum permissible noise limits for all equipment at 85 dBA (at 1 m), and for lower capacity equipment (pumps, air coolers, etc.) at 82 dBA (1 m).
- In instances where information of equipment capacities was not available, the more stringent 85 dBA criteria were assumed.
- Noise modeling assumptions were therefore conservative for some equipment that may eventually be installed with lower power ratings.



The sound emission levels for the respective equipment types are summarised in **Table 4-32**.

Table 4-32 Summary of Equipment Noise Emission Levels

Equipment	Rating	Noise Emission, SPL at 1 m
Compressors	All types	85 dBA
Fans and Blowers	All types	85 dBA
Pumps	<50 kW	80 dBA
	50kW<P<200kW	82 dBA
	>200 kW	85 dBA
Air Coolers	All types	82 dBA
Heaters, Boilers, Incinerators, Gas Treatment Packages	All types	85 dBA
Cooling Towers	All types	85 dBA
Drier Package	All types	85 dBA
All other auxiliary Packages other than the above	All types	82 dBA

Source: Project Specification- Equipment Noise Specification, PETRONAS 2013.

Flares where applicable were assumed to comply with the design specifications of 115 dBA at the respective flares boundary line (as per

	ADDITIONAL INFORMATION TO THE DEIA REFINERY AND PETROCHEMICAL INTEGRATED DEVELOPMENT (RAPID) PROJECT, PENERANG JOHOR, 2012 TO INCLUDE EURO 5 MOGAS AND OLEFIN TANK UNITS	
	CHAPTER 4 POTENTIAL ENVIRONMENTAL IMPACT AND MITIGATION MEASURES	

RAPID Complex in-plant occupational noise compliance requirements). Sound power levels with noise frequency spectrum for equipment types used in the modelling were assumed to comply with the maximum noise limit criteria (at 1 m) as specified in the Project Engineering Design. The noise frequency spectra used were based on typical measured spectrum of similar equipment in petrochemical plants.

4.3.3.3.2 Sensitive Receptors

The sensitive receptors are described in **Section 4.2**.

4.3.3.4 Modeling Findings



4.3.3.4.1 Individual Process Unit

- a) EURO 5 MOGAS Units

Table 4-33 shows the maximum steady state equivalent noise levels for the EURO 5 MOGAS Units at the EURO 5 MOGAS Units boundary and at the RAPID Complex boundary. Noise propagation from the noise sources showing noise contours to the individual process units' boundaries are given in **Figure 4-2** to **Figure 4-5**. Noise propagation to the overall RAPID Complex boundary is given in **Figure 4-6**.

Table 4-33: Maximum Steady State Equivalent LAeq Noise Levels for EURO 5 MOGAS Units

Location	Maximum Steady State L _{Aeq}			
	North	West	South	East
At CNHT 2 Unit Boundary	66 dBA	72 dBA	68 dBA	64 dBA
At Etherification (TAME) Unit Boundary	68 dBA	73 dBA	67 dBA	67 dBA
At Isomerization Unit Boundary	66 dBA	60 dBA	67 dBA	64 dBA
At Additional Storage Units Boundary	59 dBA	49 dBA	59 dBA	57 dBA
At RAPID Complex Boundary	<45 dBA	<37 dBA	<35 dBA	<37 dBA

	<p align="center">ADDITIONAL INFORMATION TO THE DEIA REFINERY AND PETROCHEMICAL INTEGRATED DEVELOPMENT (RAPID) PROJECT, PENGERANG JOHOR, 2012 TO INCLUDE EURO 5 MOGAS AND OLEFIN TANK UNITS</p>	
	<p align="center">CHAPTER 4 POTENTIAL ENVIRONMENTAL IMPACT AND MITIGATION MEASURES</p>	

- Noise emissions are fairly confined within the process unit area at the respective cracked naphtha unit, hydrotreating unit, etherification unit and isomerization unit. pumps and extruder areas and chilled water packages locations.
- The maximum steady state equivalent L_{Aeq} noise levels at the units' boundaries were typically 64 dBA to 67 dBA on the east and south boundaries, 66 dBA to 68 dBA on the north, and 60 dBA to 73 dBA on the west boundaries. At the Storage units, the noise levels were lower at 49 dBA to 59 dBA at the respective boundaries.
- Noise emissions from these process units propagated to the RAPID boundary was predicted to be less than 37 dBA at the west and east boundaries, and less than 35 dBA at the south, and up to 45 dBA L_{Aeq} at localized locations on the north boundary.
- Noise emissions during operations stage of the process unit were predicted to be negligible to all identified sensitive receptors at the RAPID Complex boundary

CHAPTER 4
POTENTIAL ENVIRONMENTAL IMPACT AND MITIGATION MEASURES

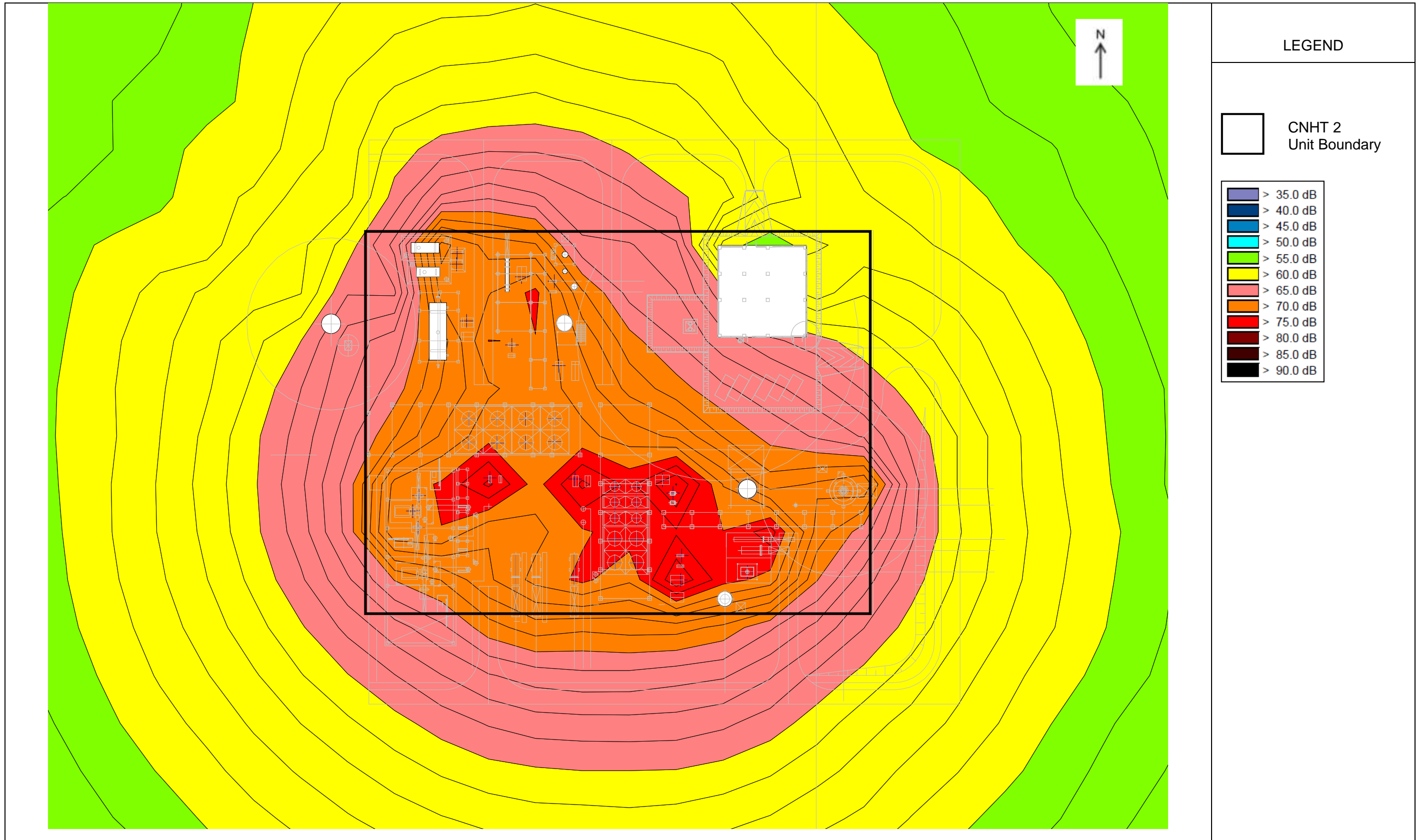


Figure 4-2: Noise Contour Generated from CNHT 2 Unit

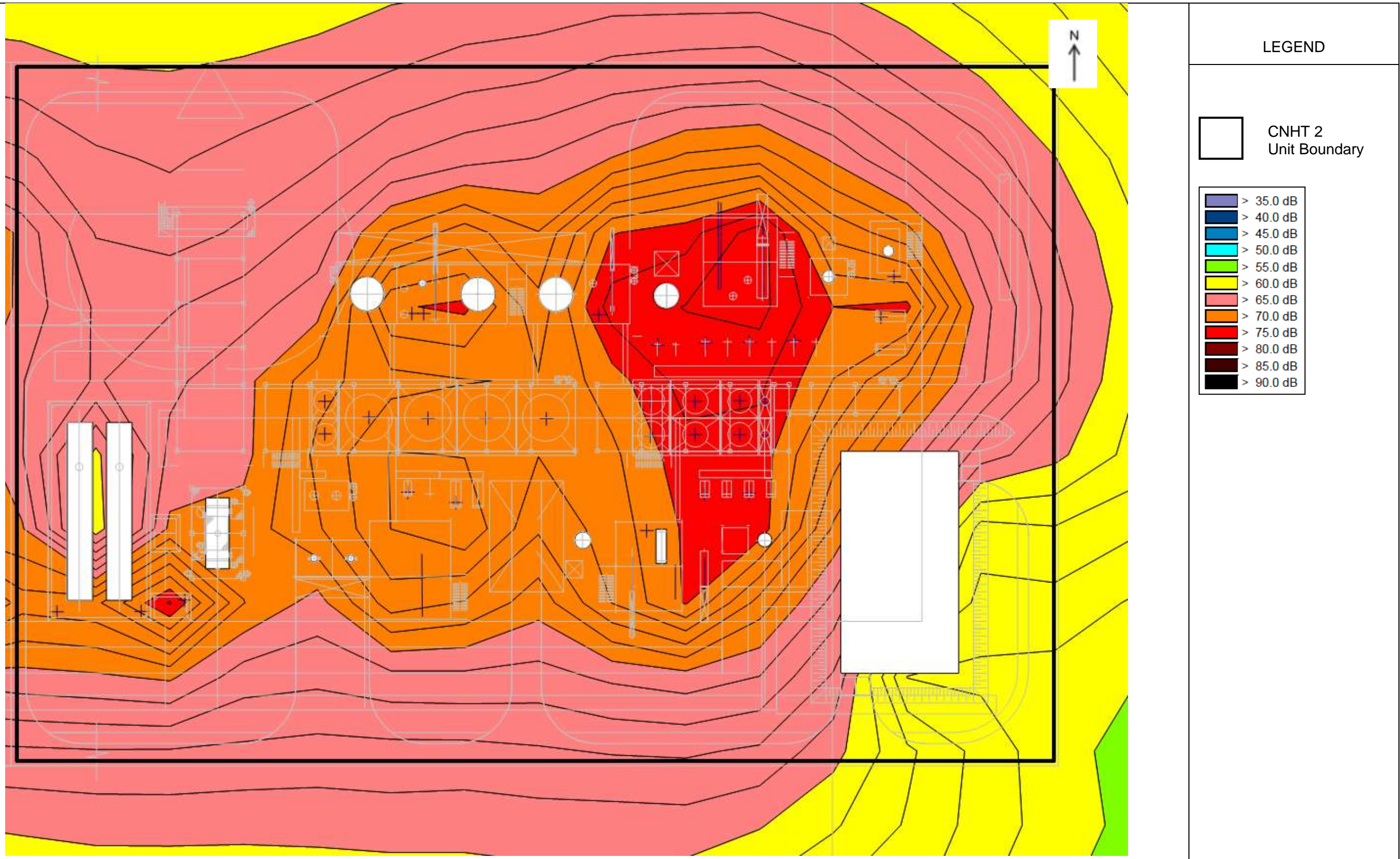
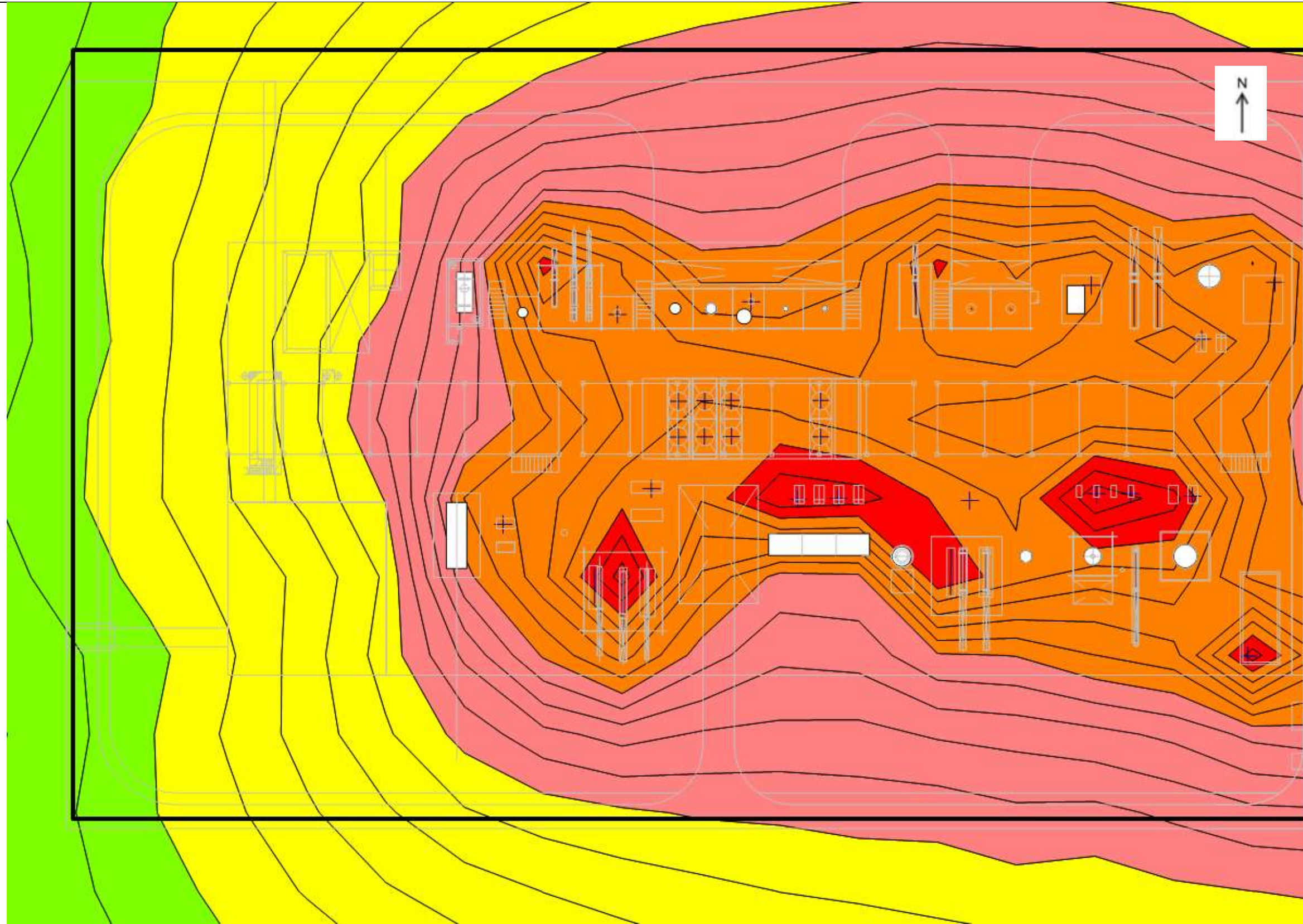
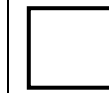


Figure 4-3: Noise Contour Generated from Etherification (TAME) Unit

CHAPTER 4
POTENTIAL ENVIRONMENTAL IMPACT AND MITIGATION MEASURES



LEGEND

 Isomerization Unit Boundary

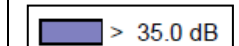

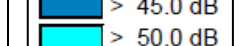
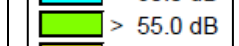
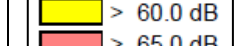
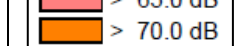

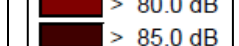
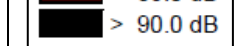
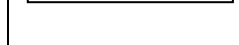


-  > 35.0 dB
-  > 40.0 dB
-  > 45.0 dB
-  > 50.0 dB
-  > 55.0 dB
-  > 60.0 dB
-  > 65.0 dB
-  > 70.0 dB
-  > 75.0 dB
-  > 80.0 dB
-  > 85.0 dB
-  > 90.0 dB

Figure 4-4: Noise Contour Generated from Isomerization Unit

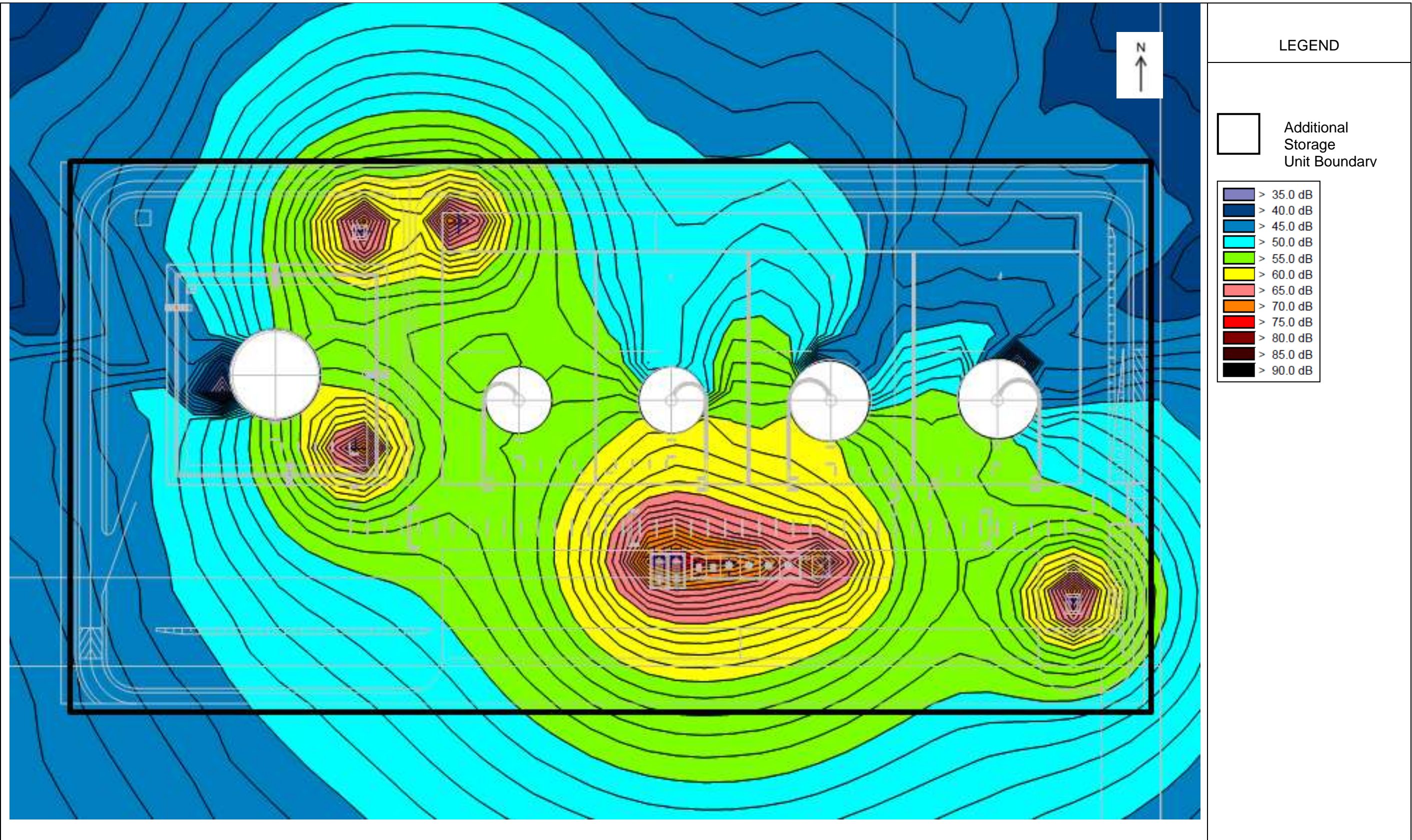


Figure 4-5: Noise Contour Generated from the Additional Storage Unit



Figure 4-6: Noise Contour Generated from EURO 5 MOGAS Units

b) Olefins Storage Tankages

Table 4-34 shows the maximum steady state equivalent noise levels for the Olefins Storage Tankages at the Olefins Storage Tankages area boundary and at the RAPID Complex boundary. Noise propagation from the noise sources showing noise contours to the Olefins Storage Tankages area boundaries are given in **Figure 4-7**. Noise propagation to the overall RAPID Complex boundary is given in **Figure 4-8**.

Table 4-34: Maximum Steady State Equivalent LAeq Noise Levels for Package 30 Process Unit

Location	Maximum Steady State L _{Aeq}			
	North	West	South	East
At Additional Olefins Storage Tankages Unit Boundary	56 dBA	48 dBA	59 dBA	64 dBA
At RAPID Complex Boundary	<35 dBA	<35 dBA	<35 dBA	<35 dBA

- Noise emissions from the Olefins Storage Tankages boundaries were determined to be typically 41 to 56 dBA on the north boundary, 49 dBA to 64 dBA on the east, 45 dBA to 59 dBA on the south and 41 dBA to 48 dBA on the west boundary.
- Noise emissions from this process unit propagated to the RAPID boundary was predicted to be less than 35 dBA at the north, east and west boundaries, and less than 36 dBA at the south unit.
- This implied that the unit noise on its own has no impact to all receivers beyond the RAPID boundary.

CHAPTER 4
POTENTIAL ENVIRONMENTAL IMPACT AND MITIGATION MEASURES

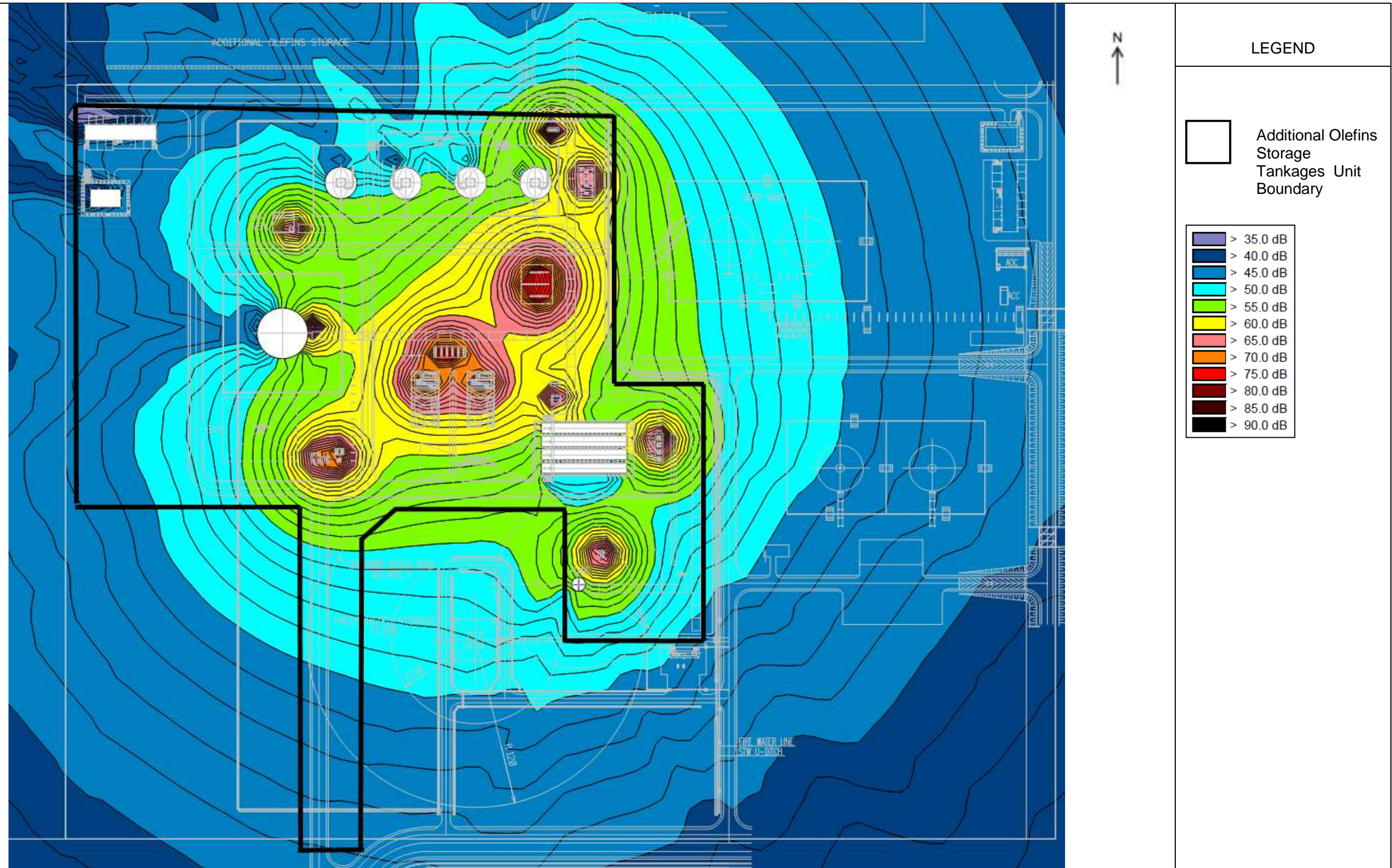


Figure 4-7: Noise Contour Generated from Additional Olefins Storage Tankages

CHAPTER 4
POTENTIAL ENVIRONMENTAL IMPACT AND MITIGATION MEASURES

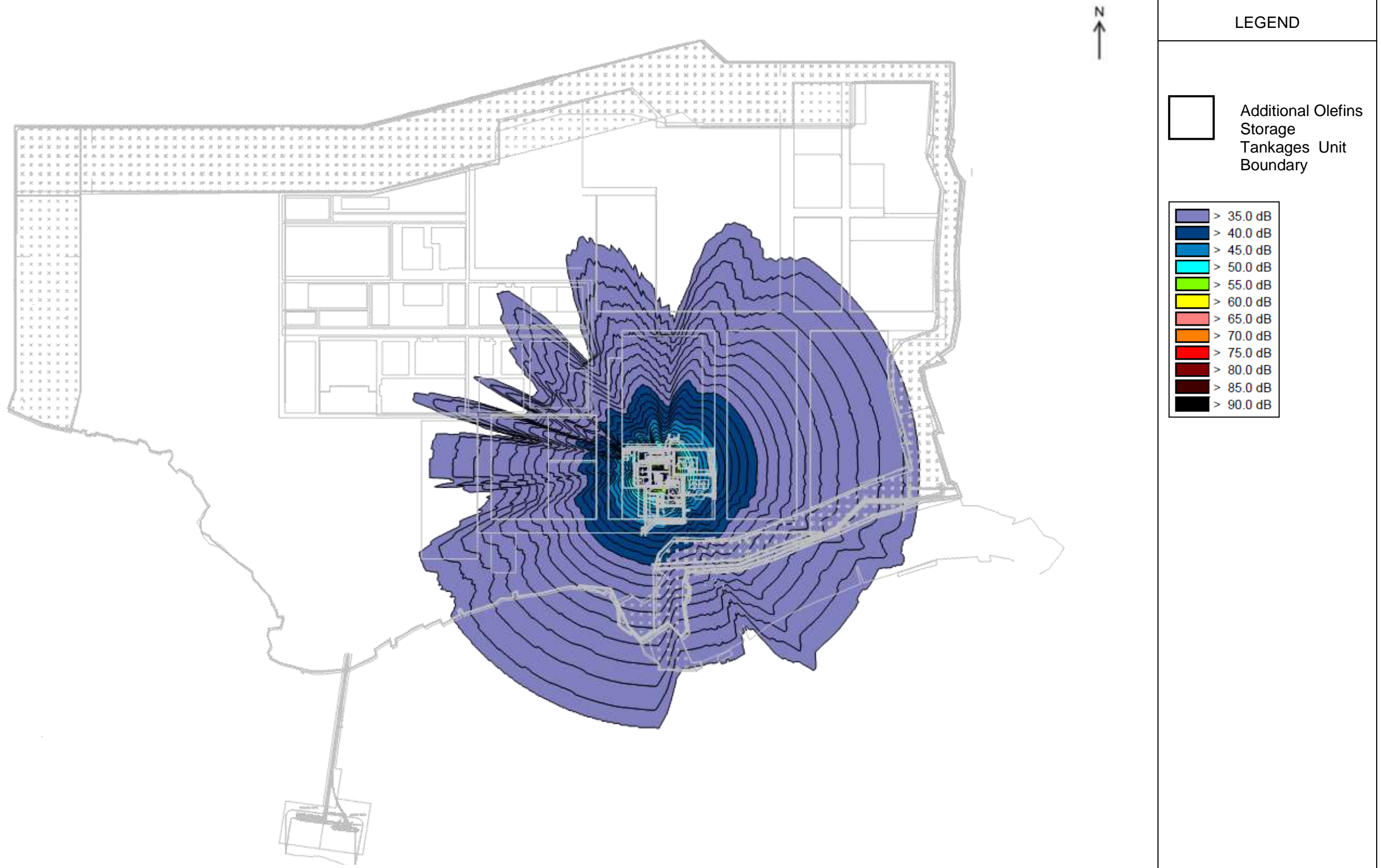




Figure 4-8: Noise Contour Generated from Olefins Storage Tankages

	ADDITIONAL INFORMATION TO THE DEIA REFINERY AND PETROCHEMICAL INTEGRATED DEVELOPMENT (RAPID) PROJECT, PENERANG JOHOR, 2012 TO INCLUDE EURO 5 MOGAS AND OLEFIN TANK UNITS	
	CHAPTER 4 POTENTIAL ENVIRONMENTAL IMPACT AND MITIGATION MEASURES	



4.3.3.4.2 Cumulative Refinery and Cracker Complex

Results for noise propagation of the Refinery and Cracker Complex process units including the new EURO 5 MOGAS Units and Olefins Storage Tankages are presented in noise maps (at elevation of 4 m) for normal operating conditions (**Volume 2, Sub Appendix 4B**).

Noise emissions from the Refinery and Cracker Complex units on its own propagated to sensitive receptors are tabulated in **Table 4-35**. Assessment of the noise emissions perceived at sensitive receptors inclusive of the prevailing ambient noise are given in **Table 4-37 and Table 4-38**. The tabulation includes existing baseline noise levels (daytime and night time) and DOE Guidelines and EIA compliance limits for comparisons.

- Noise propagated to these receivers (normal operations with no Petchem flare) from the Refinery and Cracker Complex, inclusive of the proposed EURO 5 MOGAS Units and Olefins Storage Tankages were below 35 dBA to all noise sensitive areas, except for Kg. Lepau with noise level of 54.7 dBA.
- The Refinery and Cracker Complex noise emissions when added to the existing baseline noise of the respective receivers had resultant noise maintained at the receivers' current ambient levels at all receivers, except Kg. Lepau that had an increase of 8.1 dBA daytime and 7.3 dBA night time.

The resultant noise of the Refinery and Cracker Complex process units when assessed against Schedule 1 DOE Noise Guideline noise limits confirmed compliance to the recommended limits for residential land use at all sensitive receptors, with the exception of Kg. Lepau. There were also other locations (Kg. Rengit and Kg. Pasir Gogok) with noise levels above the DOE Guidelines levels

	ADDITIONAL INFORMATION TO THE DEIA REFINERY AND PETROCHEMICAL INTEGRATED DEVELOPMENT (RAPID) PROJECT, PENERANG JOHOR, 2012 TO INCLUDE EURO 5 MOGAS AND OLEFIN TANK UNITS	
	CHAPTER 4 POTENTIAL ENVIRONMENTAL IMPACT AND MITIGATION MEASURES	

due to existing high ambient noise levels at these receptors and not from the Refinery and Cracker Complex.

Table 4-35: Summary of Noise Levels from Refinery & Cracker Complex and Other RAPID Components at Sensitive Receptors - Normal Conditions

No.	Sensitive Receptor	Equivalent Noise L_{eq} (dBA)	
		Refinery and Cracker Plant	Cumulative from Refinery, Cracker Complex, Petchem Complex and Utilities
N1	Tg. Pengelih	<35	<35
N2	Pengelih Naval Base	<35	<35
N3	Kg. Pengerang	<35	<35
N4	Kg. Sg. Kapal	<35	<35
N5	Taman Rengit Jaya	<35	<35
N6	Kg. Sg. Buntu	<35	<35
N7	Kg. Bukit Buloh	<35	<35
N8	Kg. Sg. Rengit	<35	<35
N9	Kg. Bukit Gelugor	<35	<35
N10	Kg. Lepau	54.7	54.7
N11	Kg. Pasir Gogok	<35	<35

Table 4-36: Summary of Noise Levels from Refinery & Cracker Complex and Other RAPID Components at Sensitive Receptors - Abnormal Conditions

No.	Sensitive Receptor	Equivalent Noise L_{eq} (dBA)
		Cumulative from Refinery, Cracker Complex, Petchem Complex and Utilities
N1	Tg. Pengelih	<35
N2	Pengelih Naval Base	61.3
N3	Kg. Pengerang	62.7
N4	Kg. Sg. Kapal	62.7
N5	Taman Rengit Jaya	38.1
N6	Kg. Sg. Buntu	<35
N7	Kg. Bukit Buloh	<35
N8	Kg. Sg. Rengit	<35
N9	Kg. Bukit Gelugor	<35
N10	Kg. Lepau	74.0
N11	Kg. Pasir Gogok	<35



CHAPTER 4
POTENTIAL ENVIRONMENTAL IMPACT AND MITIGATION MEASURES

Table 4-37 Summary of Predicted Cumulative Noise Level from RAPID Refinery and Cracker Complex Noise Levels during Day Time - Normal Operating Conditions

Location	Sensitive Receptors	Baseline Noise Levels, Oct 2012 (dBA)	Noise Level from Refinery and Cracker Complex (dBA)			DOE Noise Guideline Level*	Compliance Noise Level# (+3 dBA to the Baseline if higher than the regulated DOE limit)
			Noise Level from Refinery & Cracker Complex L _{Aeq}	Noise level at Receptors L _{Aeq}	Noise Increment		
N1	Tg. Pengelih	55.6	<35	55.6	0	55	58.6
N2	Pengelih Naval Base	55.6	<35	55.6	0	55	58.6
N3	Kg. Pengerang	50.5	<35	50.6	0	55	55
N4	Kg. Sg. Kapal	51.9	<35	52.0	0	55	55
N5	Taman Rengit Jaya	51.9	<35	51.9	0	55	55
N6	Kg. Sg. Buntu	49.1	<35	49.1	0	55	55
N7	Kg. Bukit Buloh	43.4	<35	43.5	0	55	55
N8	Kg. Sg. Rengit	70.7	<35	70.7	0	55	73.7
N9	Kg. Bukit Gelugor	45.2	<35	45.2	0	55	55
N10	Kg. Lepau	47.3	54.7	55.5	8.1	55	55
N11	Kg. Pasir Gogok	72.1	<35	72.1	0	55	75.1

Note: * Schedule 1 Maximum Permissible Sound Level (L_{Aeq}) by Suburban Residential Area for Planning and New Development of the Planning Guidelines for Environmental Noise Limits and Control, DOE, 2007.



The compliances noise level at the receptors is taken as baseline + 3 dBA if the current baseline is higher than the DOE Noise Guidelines Level (Schedule 3 Maximum Permissible Sound Level (L_{Aeq}) to be Maintained at the Existing Noise Climate, DOE, 2007.

Table 4-38 Summary of Predicted Cumulative Noise Level from RAPID Refinery and Cracker Complex Noise Levels during Night Time - Normal Operating Conditions

Location	Sensitive Receptors	Baseline Noise Levels, Oct 2012 (dBA)	Noise Level from Refinery and Cracker Complex (dBA)			DOE Noise Guideline Level*	Compliances Noise Level# (+3 dBA to the Baseline if higher than the regulated DOE limit)
			Noise Level from Refinery & Cracker Complex L _{Aeq}	Noise level at Receptors L _{Aeq}	Noise Increment		
N1	Tg. Pengelih	48.1	<35	48.1	0	45	51.1
N2	Pengelih Naval Base	48.1	<35	48.1	0	45	51.1
N3	Kg. Pengerang	46.2	<35	46.2	0	45	49.2
N4	Kg. Sg. Kapal	52.3	<35	52.3	0	45	55.3
N5	Taman Rengit Jaya	51.7	<35	51.7	0	45	54.7
N6	Kg. Sg. Buntu	46.2	<35	46.2	0	45	49.2
N7	Kg. Bukit Buloh	42.7	<35	42.7	0	45	45
N8	Kg. Sg. Rengit	61.5	<35	61.5	0	45	64.5
N9	Kg. Bukit Gelugor	42.3	<35	42.3	0	45	45
N10	Kg. Lepau	48.3	54.7	55.6	7.3	45	51.3
N11	Kg. Pasir Gogok	61.9	<35	61.9	0	45	64.9

Note: * Schedule 1 Maximum Permissible Sound Level (L_{Aeq}) by Suburban Residential Area for Planning and New Development of the Planning Guidelines for Environmental Noise Limits and Control, DOE, 2007.

The compliances noise level at the receptors is taken as baseline + 3 dBA if the current baseline is higher than the DOE Noise Guidelines Level (Schedule 3 Maximum Permissible Sound Level (L_{Aeq}) to be Maintained at the Existing Noise Climate, DOE, 2007.

	<p style="text-align: center;">ADDITIONAL INFORMATION TO THE DEIA REFINERY AND PETROCHEMICAL INTEGRATED DEVELOPMENT (RAPID) PROJECT, PENGERANG JOHOR, 2012 TO INCLUDE EURO 5 MOGAS AND OLEFIN TANK UNITS</p>	
	<p style="text-align: center;">CHAPTER 4 POTENTIAL ENVIRONMENTAL IMPACT AND MITIGATION MEASURES</p>	

4.3.3.4.3 Cumulative RAPID Complex



Cumulative noise impact of the Refinery and Cracker Complex (inclusive of the new EURO 5 MOGAS Units and Olefins Storage Tankages) with Other RAPID Components (i.e. Petrochemical Complex, Utilities and other supporting facilities) were also examined.

Noise studies for the RAPID Petrochemical Complex were undertaken in a Detailed EIA followed up an Addendum Study based on most current plant re-configurations and had been documented in the respective DEIA and Addendum Study Reports. The modelling undertaken herein for a cumulative RAPID Complex (i.e. Refinery and Cracker Complex (inclusive of the new EURO 5 MOGAS Units and Olefins Storage Tankages combined with Other RAPID components) provided noise propagation maps for the entire RAPID Complex.

Noise propagation maps (at elevation of 4 m) for normal and abnormal operating conditions are given in **Volume 2, Sub Appendix 4B. Table 4-35** tabulate noise levels of the cumulative RAPID Complex under normal operating conditions, and **Table 4-36** under abnormal conditions with emergency Petchem flare.

Assessment of the noise emissions perceived at sensitive receptors inclusive of the prevailing ambient noise for normal conditions are given in **Table 4-39** and **Table 4-40**; and for abnormal conditions given in **Table 4-41** and **Table 4-42**. The tabulation includes existing baseline noise levels (daytime and night time) and DOE Guidelines and EIA compliance limits for comparisons.

Observations and key findings for the cumulative noise of the RAPID Complex (Refinery, Cracker Complex, Petchem Complex, Utilities and other supporting facilities) are summarised as follows.



	<p style="text-align: center;">ADDITIONAL INFORMATION TO THE DEIA REFINERY AND PETROCHEMICAL INTEGRATED DEVELOPMENT (RAPID) PROJECT, PENERANG JOHOR, 2012 TO INCLUDE EURO 5 MOGAS AND OLEFIN TANK UNITS</p>	
	<p style="text-align: center;">CHAPTER 4 POTENTIAL ENVIRONMENTAL IMPACT AND MITIGATION MEASURES</p>	

a) Normal Operating Conditions

- Cumulative noise propagated to these receivers (normal operations with no Petchem flare) from the Refinery, Cracker Complex (inclusive of the proposed EURO 5 MOGAS Units and Olefins Storage Tankages), Petchem Complex and Utilities were below 35 dBA to all noise sensitive areas, except for Kg. Lepau with noise level of 54.7 dBA attributable to process units of the Refinery (but not the EURO 5 MOGAS Units and Olefins Storage Tankages) at the northern boundary.
- The RAPID Complex noise emissions when added to the existing baseline noise of the respective receivers had resultant noise maintained at the receivers' current ambient levels at all receivers, except Kg. Lepau that had an increase of 8.1 dBA daytime and 7.3 dBA night time.
- The resultant noise of the Refinery and Cracker Complex process units when assessed against Schedule 1 DOE Noise Guideline noise limits confirmed compliance to the recommended limits for residential land use at all sensitive receptors, with the exception of Kg. Lepau. There were also other locations (Kg. Rengit and Kg. Pasir Gogok) with noise levels above the DOE Guidelines levels due to existing high ambient noise levels at these receptors and not from the Refinery and Cracker Complex.
- For normal operating condition, the cumulative noise level from RAPID Complex (Refinery, Cracker Plant, Petrochemical Complex and utilities) were below EIA Approval noise limits (*Pindaan Syarat Kelulusan Laporan EIA Terperinci* dated 7th January 2013) at all RAPID boundaries.



b) Abnormal Conditions

- Noise propagated under abnormal conditions mainly due to emergency flaring from the RAPID Common Flare resulted in noise levels of 74 dBA at Kg Lepau (due to proximity of this receptor to the

	<p align="center">ADDITIONAL INFORMATION TO THE DEIA REFINERY AND PETROCHEMICAL INTEGRATED DEVELOPMENT (RAPID) PROJECT, PENGERANG JOHOR, 2012 TO INCLUDE EURO 5 MOGAS AND OLEFIN TANK UNITS</p>	
	<p align="center">CHAPTER 4 POTENTIAL ENVIRONMENTAL IMPACT AND MITIGATION MEASURES</p>	

RAPID development), and 61 dBA to 63 dBA at Pengelih Naval Base, Kg. Pengerang and Kg. Sg Kapal. At other sensitive receptors noise levels under abnormal conditions were below 35 dBA to 40 dBA.

- The above mentioned receptors are anticipated to have resultant noise levels during these abnormal conditions to be significantly higher than the respective prevailing ambient noise levels (i.e. significant noise level increase above baseline levels) daytime and night time.
- The noise levels under abnormal conditions when assessed against EIA Approval noise limits (*Pindaan Syarat Kelulusan Laporan EIA Terperinci* dated 7th January 2013) showed that all sensitive receptors were below the EIA Approval limits, except for Pengelih Naval Base, Kg. Pengerang, Kg. Sg. Kapal, Kg. Sg Rengit and Kg. Lepau.
- In general, the operation of RAPID Petrochemical Plants and RAPID Complex has insignificant increase from the baseline level to the surroundings and at identified sensitive receptor locations;
- The projected cumulative noise level from RAPID Complex (Petrochemical Plants and other RAPID components) received by the receptors ranges from 39.1 dBA (at Tg Pengelih) to 55.2 dBA (at Kg Lepau);
- Noise level generated by the RAPID Petrochemical Plants when they are in operation is predicted to be below the required compliance noise level at the sensitive receptors locations except for Kg Lepau, which is closest to the northern RAPID site boundary.
- The projected noise generated level generated by the Petrochemical Plant operation to Kg Lepau exceeds the compliance limit at night time by 3.0 dBA i.e. 54.3 dBA compared to the compliance limit of 51.3 dBA;
- When RAPID Complex is in full operation, the projected cumulative noise level for daytime is expected to be below the required compliance limit at the sensitive receptor locations except for noise level at Kg Lepau where the noise level is higher by 0.8 dBA from the compliance noise limit.

 PETRONAS	ADDITIONAL INFORMATION TO THE DEIA REFINERY AND PETROCHEMICAL INTEGRATED DEVELOPMENT (RAPID) PROJECT, PENERANG JOHOR, 2012 TO INCLUDE EURO 5 MOGAS AND OLEFIN TANK UNITS	 INTEGRATED ENVIROTECH
	CHAPTER 4 POTENTIAL ENVIRONMENTAL IMPACT AND MITIGATION MEASURES	

- It is to be noted that the above noise impact occurs during abnormal conditions when the RAPID Common flare is in operation which happens only during upset or emergency conditions. Under such circumstances, flaring is also typically short duration.



CHAPTER 4
POTENTIAL ENVIRONMENTAL IMPACT AND MITIGATION MEASURES

Table 4-39 Summary of Predicted Cumulative Noise Level from RAPID Refinery, Cracker Plant, Petrochemical Complex and Utilities during Day Time - Normal Operating Conditions

Location	Sensitive Receptors	Baseline Noise Levels, Oct 2012 (dBA)	Noise Level from Refinery and Cracker Complex (dBA)			DOE Noise Guideline Level*	Compliance Noise Level# (+3 dBA to the Baseline if higher than the regulated DOE limit)
			Noise Level from Refinery, Cracker Complex, Petchem Complex and Utilities L _{Aeq}	Noise level at Receptors L _{Aeq}	Noise Increment		
N1	Tg. Pengelih	55.6	<35	55.6	0	55	58.6
N2	Pengelih Naval Base	55.6	<35	55.6	0	55	58.6
N3	Kg. Pengerang	50.5	<35	50.6	0	55	55
N4	Kg. Sg. Kapal	51.9	<35	52.0	0	55	55
N5	Taman Rengit Jaya	51.9	<35	51.9	0	55	55
N6	Kg. Sg. Buntu	49.1	<35	49.1	0	55	55
N7	Kg. Bukit Buloh	43.4	<35	43.5	0	55	55
N8	Kg. Sg. Rengit	70.7	<35	70.7	0	55	73.7
N9	Kg. Bukit Gelugor	45.2	<35	45.2	0	55	55
N10	Kg. Lepau	47.3	54.7	55.5	8.1	55	55
N11	Kg. Pasir Gogok	72.1	<35	72.1	0	55	75.1

Note: * Schedule 1 Maximum Permissible Sound Level (L_{Aeq}) by Suburban Residential Area for Planning and New Development of the Planning Guidelines for Environmental Noise Limits and Control, DOE, 2007.
The compliances noise level at the receptors is taken as baseline + 3 dBA if the current baseline is higher than the DOE Noise Guidelines Level (Schedule 3 Maximum Permissible Sound Level (L_{Aeq}) to be Maintained at the Existing Noise Climate, DOE, 2007.

Table 4-40 Summary of Predicted Cumulative Noise Level from RAPID Refinery, Cracker Plant, Petrochemical Complex and Utilities during Night Time - Normal Operating Conditions

Location	Sensitive Receptors	Baseline Noise Levels, Oct 2012 (dBA)	Noise Level from Refinery and Cracker Complex (dBA)			DOE Noise Guideline Level*	Compliances Noise Level# (+3 dBA to the Baseline if higher than the regulated DOE limit)
			Noise Level from Refinery, Cracker Complex, Petchem Complex and Utilities L _{Aeq}	Noise level at Receptors L _{Aeq}	Noise Increment		
N1	Tg. Pengelih	48.1	<35	48.1	0	45	51.1
N2	Pengelih Naval Base	48.1	<35	48.1	0	45	51.1
N3	Kg. Pengerang	46.2	<35	46.2	0	45	49.2
N4	Kg. Sg. Kapal	52.3	<35	52.3	0	45	55.3
N5	Taman Rengit Jaya	51.7	<35	51.7	0	45	54.7
N6	Kg. Sg. Buntu	46.2	<35	46.2	0	45	49.2
N7	Kg. Bukit Buloh	42.7	<35	42.7	0	45	45
N8	Kg. Sg. Rengit	61.5	<35	61.5	0	45	64.5
N9	Kg. Bukit Gelugor	42.3	<35	42.3	0	45	45
N10	Kg. Lepau	48.3	54.7	55.6	7.3	45	51.3
N11	Kg. Pasir Gogok	61.9	<35	61.9	0	45	64.9

Note: * Schedule 1 Maximum Permissible Sound Level (L_{Aeq}) by Suburban Residential Area for Planning and New Development of the Planning Guidelines for Environmental Noise Limits and Control, DOE, 2007.
The compliances noise level at the receptors is taken as baseline + 3 dBA if the current baseline is higher than the DOE Noise Guidelines Level (Schedule 3 Maximum Permissible Sound Level (L_{Aeq}) to be Maintained at the Existing Noise Climate, DOE, 2007.



CHAPTER 4
POTENTIAL ENVIRONMENTAL IMPACT AND MITIGATION MEASURES

Table 4-41 Summary of Predicted Cumulative Noise Level from RAPID Refinery, Cracker Plant, Petrochemical Complex and Utilities during Day Time - Abnormal Operating Conditions

Location	Sensitive Receptors	Baseline Noise Levels, Oct 2012 (dBA)	Noise Level from Refinery and Cracker Complex (dBA)			DOE Noise Guideline Level*	Compliance Noise Level# (+3 dBA to the Baseline if higher than the regulated DOE limit)
			Noise Level from Refinery, Cracker Complex, Petchem Complex and Utilities L _{Aeq}	Noise level at Receptors L _{Aeq}	Noise Increment		
N1	Tg. Pengelih	55.6	<35	55.6	0	55	58.6
N2	Pengelih Naval Base	55.6	61.3	62.3	6.7	55	58.6
N3	Kg. Pengerang	50.5	62.7	63.0	12.5	55	55
N4	Kg. Sg. Kapal	51.9	62.7	63.0	11.1	55	55
N5	Taman Rengit Jaya	51.9	38.1	52.1	0.2	55	55
N6	Kg. Sg. Buntu	49.1	<35	49.1	0	55	55
N7	Kg. Bukit Buloh	43.4	<35	43.5	0	55	55
N8	Kg. Sg. Rengit	70.7	<35	70.7	0	55	73.7
N9	Kg. Bukit Gelugor	45.2	<35	45.2	0	55	55
N10	Kg. Lepau	47.3	74.0	74.0	26.7	55	55
N11	Kg. Pasir Gogok	72.1	<35	72.1	0	55	75.1



Note: * Schedule 1 Maximum Permissible Sound Level (L_{Aeq}) by Suburban Residential Area for Planning and New Development of the Planning Guidelines for Environmental Noise Limits and Control, DOE, 2007.

The compliances noise level at the receptors is taken as baseline + 3 dBA if the current baseline is higher than the DOE Noise Guidelines Level (Schedule 3 Maximum Permissible Sound Level (L_{Aeq}) to be Maintained at the Existing Noise Climate, DOE, 2007.

Table 4-42 Summary of Predicted Cumulative Noise Level from RAPID Refinery, Cracker Plant, Petrochemical Complex and Utilities during Night Time - Abnormal Operating Conditions

Location	Sensitive Receptors	Baseline Noise Levels, Oct 2012 (dBA)	Noise Level from Refinery and Cracker Complex (dBA)			DOE Noise Guideline Level*	Compliances Noise Level# (+3 dBA to the Baseline if higher than the regulated DOE limit)
			Noise Level from Refinery, Cracker Complex, Petchem Complex and Utilities L _{Aeq}	Noise level at Receptors L _{Aeq}	Noise Increment		
N1	Tg. Pengelih	48.1	<35	48.1	0	45	51.1
N2	Pengelih Naval Base	48.1	61.3	62.3	13.4	45	51.1
N3	Kg. Pengerang	46.2	62.7	63.0	16.6	45	49.2
N4	Kg. Sg. Kapal	52.3	62.7	63.0	10.8	45	55.3
N5	Taman Rengit Jaya	51.7	38.1	52.1	0.2	45	54.7
N6	Kg. Sg. Buntu	46.2	<35	49.1	0	45	49.2
N7	Kg. Bukit Buloh	42.7	<35	43.5	0	45	45
N8	Kg. Sg. Rengit	61.5	<35	70.7	0	45	64.5
N9	Kg. Bukit Gelugor	42.3	<35	45.2	0	45	45
N10	Kg. Lepau	48.3	74.0	74.0	25.7	45	51.3
N11	Kg. Pasir Gogok	61.9	<35	61.9	0	45	64.9

Note: * Schedule 1 Maximum Permissible Sound Level (L_{Aeq}) by Suburban Residential Area for Planning and New Development of the Planning Guidelines for Environmental Noise Limits and Control, DOE, 2007.# The compliances noise level at the receptors is taken as baseline + 3 dBA if the current baseline is higher than the DOE Noise Guidelines Level (Schedule 3 Maximum Permissible Sound Level (L_{Aeq}) to be Maintained at the Existing Noise Climate, DOE, 2007.

	<p style="text-align: center;">ADDITIONAL INFORMATION TO THE DEIA REFINERY AND PETROCHEMICAL INTEGRATED DEVELOPMENT (RAPID) PROJECT, PENGERANG JOHOR, 2012 TO INCLUDE EURO 5 MOGAS AND OLEFIN TANK UNITS</p>	
	<p style="text-align: center;">CHAPTER 4 POTENTIAL ENVIRONMENTAL IMPACT AND MITIGATION MEASURES</p>	

4.3.3.5 Mitigation Measures

4.3.3.5.1.1 Potential Impact

- Potential impact under normal plant operations are typically marginal noise increase to Kg, Lepau with nominal increase in the ambient noise levels not likely to result in significant nuisance to the surrounding communities.
- Under abnormal conditions, there is a temporary noise disturbance which are transient (short duration) during the RAPID Complex emergency flaring for Plant safety.

4.3.3.5.1.2 Mitigating Measures

The proposed noise mitigation measures are:

- Specification in the design that requires for use of acoustic enclosures for high noise-generating equipment. These are usually for compression package systems and turbine driven generators (if used). Other high noise equipment (chillers, etc.) could also be installed within an enclosed room / area. Major noise sources and/or equipment at these other RAPID components shall be fitted with acoustics enclosures, silencers or acoustic lagging as appropriate.
Noise from Petchem flare during normal plant operations shall be mitigated through design and selection of the flare system that specify for use of low noise flare types and/or pressure reduction devices.

4.3.4 EFFLUENT DISPERSION MODELING

4.3.4.1 Introduction

4.3.4.1.1 Effluent Management Philosophy

All of the effluent from the sources within RAPID, including from the Refinery and Cracker Complex will be treated at a centralized treatment facility called RAPID Effluent Treatment Plant (ETP) prior to discharge to the marine water via a submerged single marine outfall (**Figure 4-10**).

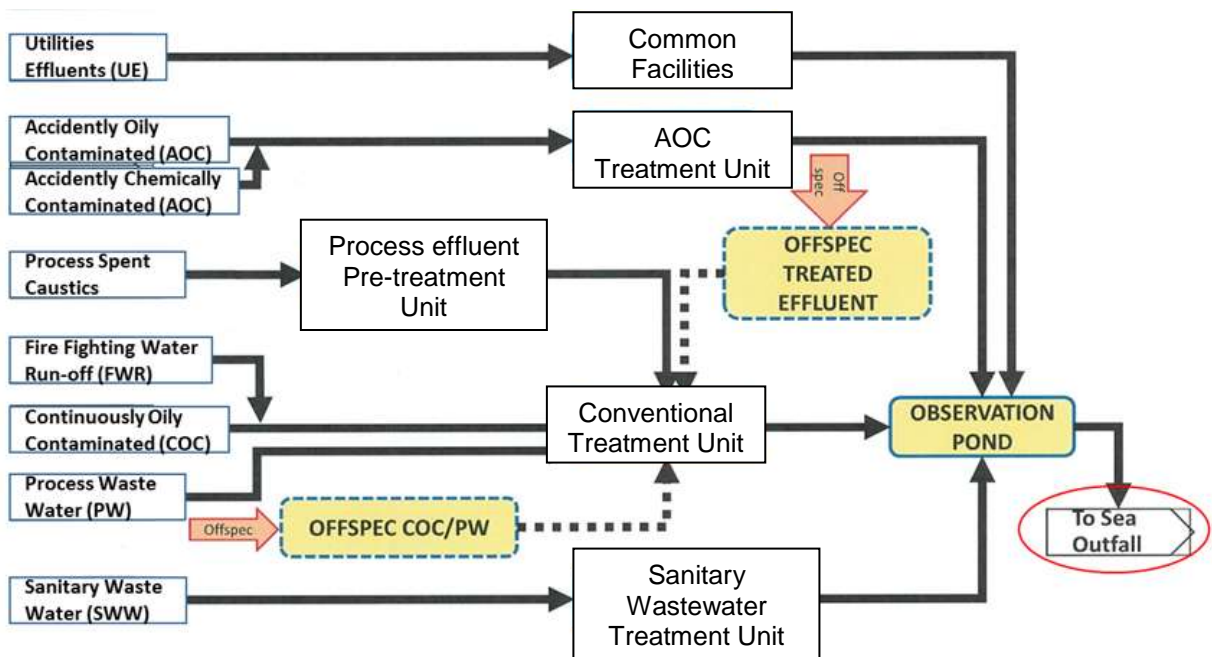


Figure 4-9: Overall Block Diagram of RAPID Effluent Treatment Plant (ETP)

The type of effluents originated from RAPID that shall enter the ETP for treatment is listed in **Table 4-43**.



	<p style="text-align: center;">ADDITIONAL INFORMATION TO THE DEIA REFINERY AND PETROCHEMICAL INTEGRATED DEVELOPMENT (RAPID) PROJECT, PENGERANG JOHOR, 2012 TO INCLUDE EURO 5 MOGAS AND OLEFIN TANK UNITS</p>	
	<p style="text-align: center;">CHAPTER 4 POTENTIAL ENVIRONMENTAL IMPACT AND MITIGATION MEASURES</p>	

Table 4-43: General Description of Effluent Type from RAPID

No.	Acronym	Effluent General Description
1.	AOC	Accidentally oil contaminated storm water
2.	ACC	Accidentally Chemically Contaminated Water
3.	FWR	Fire-Fighting Water Run-Off
4.	COC	Continuously Oil Contaminated Water
5	PW	Process Waste Water
6.	UE	Utilities Effluents
7.	SWW	Sanitary Wastewater

4.3.4.1.1.1 Effluent Treatment Plant (ETP) Design

The ETP is designed to comply with SPAN Malaysian Sewerage Industry Guideline, EQA (Sewage and Industrial Effluent Regulation 2009 and Clean Air Regulation Regulation 2014, International Finance Corporation (IFC) EHS and Industry Sector Guideline and based on Best Management Practices & Best Available Techniques (BAT).



As shown in **Figure 4-9**, effluents from all sources within RAPID including the RAPID PETCHEM Complex shall undergo stages of treatment before entering the observation pond and eventually discharged into the marine water via the marine outfall. The treatment units are shown **Figure 4-9** and described in **Table 4-44**.

Table 4-44: Description of Treatment Units

Unit	Purpose
Common Facilities: <ul style="list-style-type: none"> • ACC Collection Unit • Offspec Collection System • UE+RFCC Treatment • Sanitary Collection 	Runoff collection facility for ETP area Storage facility for offspec Removal of Solids from Blowdown Collection system for Sanitary from ETP
AOC Treatment Unit	Removal of Oil & TSS from Runoff Water
Process Effluent Pre-Treatment Unit	Spent Caustic effluent treated to make it easily biodegradable
Conventional treatment Unit	Treatment of Process effluent for removal of Oil, TSS and other organics
Sanitary Wastewater Treatment Unit	For the removal of Solids and organics in the sanitary stream
Sludge Treatment Unit	To reduce moisture content and make it easy for transportation
Vapor Recovery Unit	Treatment for removal of VOC in the air emitted to atmosphere
Slop oil Handling Unit	Segregation, Storage and loading facility of Slop oil

4.3.4.1.1.2 Off-spec Condition

The ETP is designed in a way that compliance to regulatory requirements is ensured. Off-spec condition is defined as unusual condition whether it is contributed from the process area or within ETP which is caused by unexpected or accidental units upset and increased flow or pollutant load. This condition is detected via online flow meters, online analyzers and lab test (periodic and as required). In the event of off-spec condition, the off-spec treated effluent shall be diverted back to unit Conventional Treatment Unit to be treated at controlled flow rate before entering the observation pond and finally discharged via the marine outfall. Only effluent which is monitored

	ADDITIONAL INFORMATION TO THE DEIA REFINERY AND PETROCHEMICAL INTEGRATED DEVELOPMENT (RAPID) PROJECT, PENERANG JOHOR, 2012 TO INCLUDE EURO 5 MOGAS AND OLEFIN TANK UNITS	
	CHAPTER 4 POTENTIAL ENVIRONMENTAL IMPACT AND MITIGATION MEASURES	

and tested to be complying with regulatory requirements shall be discharged from the observation pond into the marine outfall.

4.3.4.1.1.3 Marine outfall

Pipeline from the observation pond will be buried and connected to a submerged marine outfall located south of the site, offshore from Tanjung Setapa as shown in **Figure 4-10**. The details of marine outfall is shown in **Table 4-45**.

Table 4-45: Details of Marine Outfall

Coordinate of the proposed outfall location in UTM 47	404277.7E m, 147267.9N m
Pipeline details	Twin HDPE pipeline with 800m diameter Total length approximately 3km (1.5km installed underground at land side and 1.5 km installed in a trenched seabed).
Discharge depth	-4 m chart datum (CD)
Design flow rate	1.49 m ³ /s (for underground and submerged pipe)

The estimated discharge flow rate from the observation pond is 1.49 m³/s (5,355 m³/hour). Break down of the total design flow rate going into the observation pond is shown in **Table 4-46**.

Table 4-46: Design Flowrate from ETP tanks into the ETP Observation Pond

Source	Flow Rate (m ³ /hr)
Treated effluent from AOC	2,041
Treated effluent from COC/PW	990
Treated effluent from SWW	16
Treated effluent from UE	1,566
Rainfall intensity of 180 mm/hr	743
Total flow rate to observation pond/ marine outfall	5,355

CHAPTER 4
POTENTIAL ENVIRONMENTAL IMPACT AND MITIGATION MEASURES

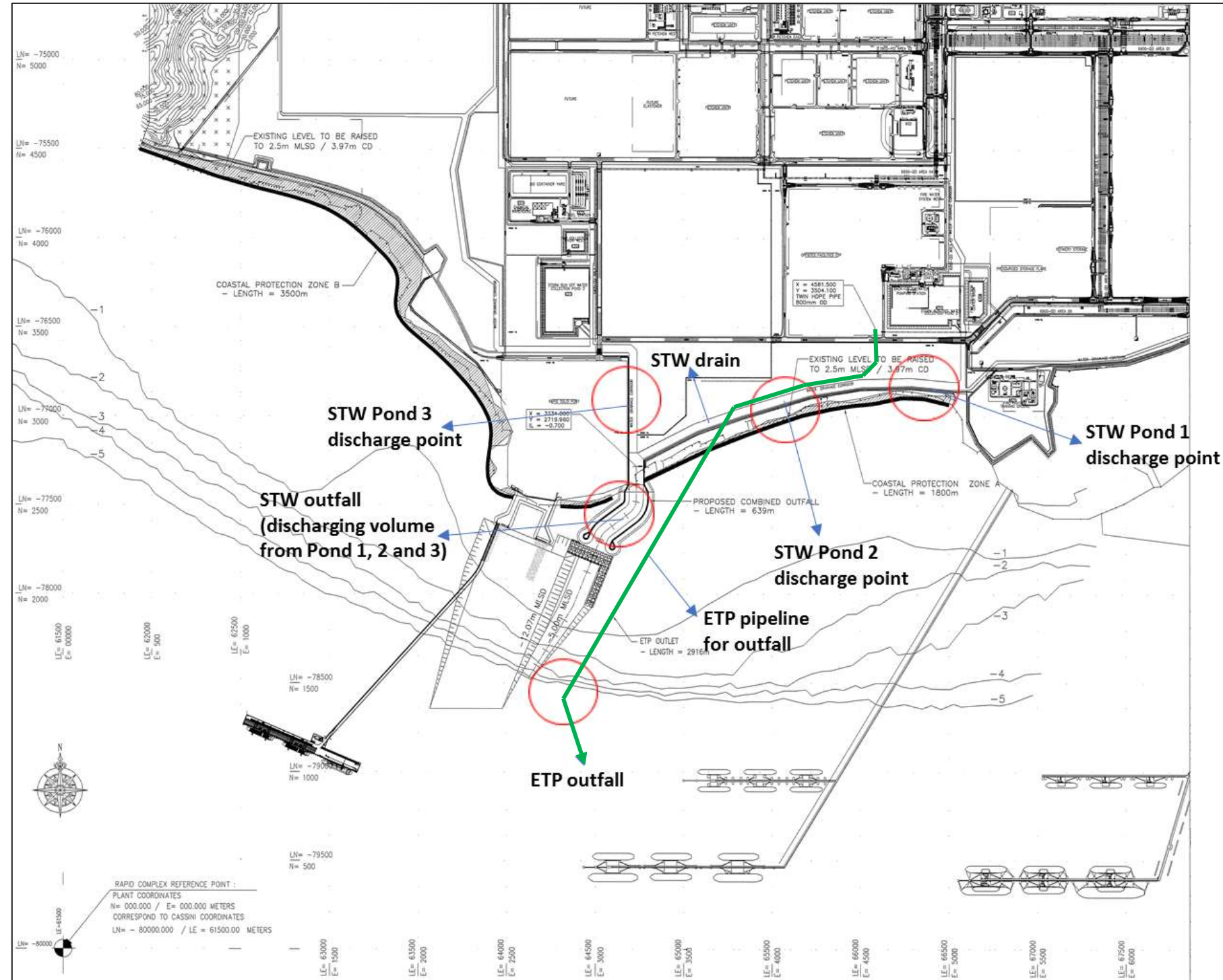




Figure 4-10: Location of the proposed outfall from RAPID complex.



	ADDITIONAL INFORMATION TO THE DEIA REFINERY AND PETROCHEMICAL INTEGRATED DEVELOPMENT (RAPID) PROJECT, PENERANG JOHOR, 2012 TO INCLUDE EURO 5 MOGAS AND OLEFIN TANK UNITS	
	CHAPTER 4 POTENTIAL ENVIRONMENTAL IMPACT AND MITIGATION MEASURES	

4.3.4.1.1.4 Discharge Monitoring

Treated effluent shall be monitored at each of the treatment units and observation pond via online analyzer and lab testing to ensure that the discharge from the observation pond comply with the regulated parameters. Regulated parameters of the discharged effluent shall not exceed the concentration limits described in **Table 4-47**. Comparison of the Project Standard with the Malaysian Standard B and RAPID Design Limit is also shown in the same table.

Table 4-47: Parameters of effluent that is regulated for compliance.

No.	Parameters	Unit	RAPID Project Treatment Standard	Malaysian Standard B
1	pH	-	5.5 to 9.0	6
2	Chemical Oxygen Demand (COD)	[mg/l]	150	200
3	Biological Oxygen Demand (BOD ₅)	[mg/l]	25	50
4	Total Suspended Solid (TSS)	[mg/l]	30	100
5	Oil & Grease	[mg/l]	10	10
6	Total Phosphorus (P-TOT)	[mg/l]	2	-
7	Total Nitrogen (N-NGL)	[mg/l]	10	-
8	Benzene	[mg/l]	0.05	-
9	Phenol	[mg/l]	0.2	1
10	Sulphide	[mg/l]	0.5	0.5
11	Colour	[ADMI]	200	200
12	Ammoniacal Nitrogen	[mg/l]	5	5
13	Nitrate Nitrogen	[mg/l]	10	10
14	Phosphorus	[mg/l]	2	-
15	Total Coliform Bacteria	[MPN/100ml]	400	-

	<p style="text-align: center;">ADDITIONAL INFORMATION TO THE DEIA REFINERY AND PETROCHEMICAL INTEGRATED DEVELOPMENT (RAPID) PROJECT, PENGERANG JOHOR, 2012 TO INCLUDE EURO 5 MOGAS AND OLEFIN TANK UNITS</p>	
	<p style="text-align: center;">CHAPTER 4 POTENTIAL ENVIRONMENTAL IMPACT AND MITIGATION MEASURES</p>	

4.3.4.2 Study Objective, Approach & Methodology

4.3.4.2.1 Objective

The study objective is to carry out the dispersion modelling and evaluate potential impacts of the discharged effluent from the marine outfall of the proposed RAPID Effluent Treatment Plant (ETP).

It should be noted that no JPS approval is required for this study as another cumulative hydraulic study is currently being undertaken for a separate EIA study for the RAPID Solid Product Jetty (SPJ) and approval from JPS was obtained for that EIA study. That study will include all RAPID marine structures such as Solid Product Jetty (SPJ), Effluent Treatment Plant (ETP) outfall, Storm Water Outfall (SWO) and Material Offloading Facility (MOLF) at Tanjung Setapa. Reference is to be made to that study and result of the dispersion modelling for the ETP outfall shall be in reference to the studies conducted under the SPJ EIA.

Details of approach & methodology are further described in **Volume 1, Chapter 3**.



4.3.4.2.2 Modelling Scenarios

Parameters to be simulated are as listed in **Table 4-47**. Modelling scenarios considered is the discharge from Observation Pond.

4.3.4.2.3 Simulated Climatic Conditions

Three (3) climatic conditions have been defined for this assessment, as follows:

- **Northeast Monsoon conditions (NE)** that represent flows during Northeast Monsoon periods when winds and tidal currents interact.

	<p>ADDITIONAL INFORMATION TO THE DEIA REFINERY AND PETROCHEMICAL INTEGRATED DEVELOPMENT (RAPID) PROJECT, PENERANG JOHOR, 2012 TO INCLUDE EURO 5 MOGAS AND OLEFIN TANK UNITS</p>	
	<p>CHAPTER 4 POTENTIAL ENVIRONMENTAL IMPACT AND MITIGATION MEASURES</p>	

The wind from the N-NE is predominant during this monsoon season. Wind with magnitude of 5 m/s coming from 20 degree has been used.

- **Southwest Monsoon conditions (SW)** that represent flows during Southwest Monsoon periods when tidal currents interact with predominant winds from S-SE. For this, wind with magnitude of 5 m/s coming from 180 degree was used.
- **Inter-Monsoon conditions (IM):** Represents conditions during Inter-Monsoon events when winds are not significant therefore flows are mainly tidal driven. This scenario is also referred as pure tides.

4.3.4.3 Modeling Findings

4.3.4.3.1 Changes in Salinity Variations in the Receiving Waters

The discharged treated effluent may change or reduce the salinity level of the ambient marine water thus changing the density in the water body within the vicinity of the outfall.

The assessment of salinity properties and its distribution has been carried out by quantifying maximum reduction in salinity distribution for the surface layer of the water column. The numerical value were calculated over a 14-day period and compared to the ambient salinity. The maximum reduction in salinity due to the mixing of fresh water with marine water is then quantified and can be found in **Volume 2, Appendix 6**. The figure shows the changes in salinity near the outfall after effluent release.

The predicted modelling results show that:

Reduction in salinity is below 1.35 PSU (less than 4.5% of ambient salinity) occur only around the outfall area, further 4 km away show smaller variations of less than 1%. So the changes are considered minor and localised around the outfall and within the project area



4.3.4.3.2 Dispersion and Dilution of Effluent

Regulated effluent load discharged from the outfall were introduced into the model domain for this assessment. Parameters of the effluent, concentration and the loading is listed in the **Table 4-48** below. These parameters are assumed to be conservative (non- decaying) in the model thus providing more conservative input. Effect from the diffusers has not included in the modeling as this will be as the conservative approach. Parameters such as pH and colour listed in **Table 4-47** has not been modeled in this study due to the complexity of the model and require more computation time. Results from the modeling are presented as excess of the released effluent concentration from the background concentration. The dispersion contour can be found in **Volume 2, Appendix 6**.

Table 4-48: Modeled pollutant concentration and loading.

Parameters	Flow rate	Concentration	Load per day
COD (from AOC, PW & COC, SWW)	3,044 m ³ /hr	150 mg/l	10,960 kg
BOD (from AOC, PW & COC, SWW)	3,050 m ³ /hr	25 mg/l	1,830 kg
TSS (from AOC, PW & COC, SWW, UE)	4, 624 m ³ /hr	30 mg/l	3,329 kg
Oil & Grease (from AOC, PW & COC, SWW)	3,047 m ³ /hr	10 mg/l	731 kg
Total Phosphorus (from AOC, PW & COC)	3,031 m ³ /hr	2 mg/l	145 kg
Total Nitrogen (from PW & COC)	990 m ³ /hr	10 mg/l	238 kg
Benzene (from PW & COC)	990 m ³ /hr	0.05 mg/l	1 kg
Phenol (from PW & COC)	990 m ³ /hr	0.2 mg/l	5 kg
Sulphide (from PW & COC)	990 m ³ /hr	0.5 mg/l	12 kg
Ammoniacal Nitrogen (from SWW)	16 m ³ /hr	5 mg/l	2 kg
Nitrate Nitrogen (from SWW)	16 m ³ /hr	10 mg/l	4 kg
Phosphorus (from SWW)	16 m ³ /hr	2 mg/l	1 kg
Total Coliform Bacteria (from SWW)	16 m ³ /hr	400 MPN/100ml	-

* Accidentally Oily Contaminated (AOC), Continuously Oily Contaminated (COC), Process Waste Water (PW), Utilities Effluents (UE), Sanitary Waste Water (SWW).

	<p style="text-align: center;">ADDITIONAL INFORMATION TO THE DEIA REFINERY AND PETROCHEMICAL INTEGRATED DEVELOPMENT (RAPID) PROJECT, PENGERANG JOHOR, 2012 TO INCLUDE EURO 5 MOGAS AND OLEFIN TANK UNITS</p>	
	<p style="text-align: center;">CHAPTER 4 POTENTIAL ENVIRONMENTAL IMPACT AND MITIGATION MEASURES</p>	

For this assessment, the background concentration in the model domain has been set to zero throughout the whole modelling period and modelling results were presented as the ratio between the load in the model domain and the load in the effluent from the outfall. In general, from the presented results, the following can be observed:

- The predicted maximum concentration of pollutant is less than 3% for all climatic conditions.
- During the NE monsoon, the dispersed pollutant concentration tend to move away from the coastline at the east side of the outfall.
- The maximum concentration reduce quickly at area 5km away from the outfall area with an overall reduction of 97 percent. This shows that the water exchange at the outfall is expected to be good. Any potential impacts to the ambient water quality are predicted to be localised and minor.

4.3.4.3.3 Water Quality

Potential changes in water quality conditions were evaluated with the outfall in operation and compared to the background conditions taken from field measurement. Measurement from sampling station CS1, CS2 and CS5 are located close to the outfall and used in the assessment. Location of the selected stations is shown in **Figure 4-11**. Excess concentration from the effluent dispersal has been added up to the background concentration (in 2012 and 2016) and compared with Class 3 of Malaysia Marine Water Quality Standards of 29th November 2010. Maximum water quality parameter concentrations at the project site after the release of effluent is shown in **Table 4-49** and **Table 4-50** . Predicted parameter concentration near the project site during the release from effluent treatment plant is below the Class 3 limit of Malaysia Marine Water Quality Standard (MMWQS) except for nitrate as it can be seen from **Table 4-49** the ambient concentration for nitrate is already above the Malaysia Marine Water Quality Standard (MMWQS) limit of 1 mg/l.

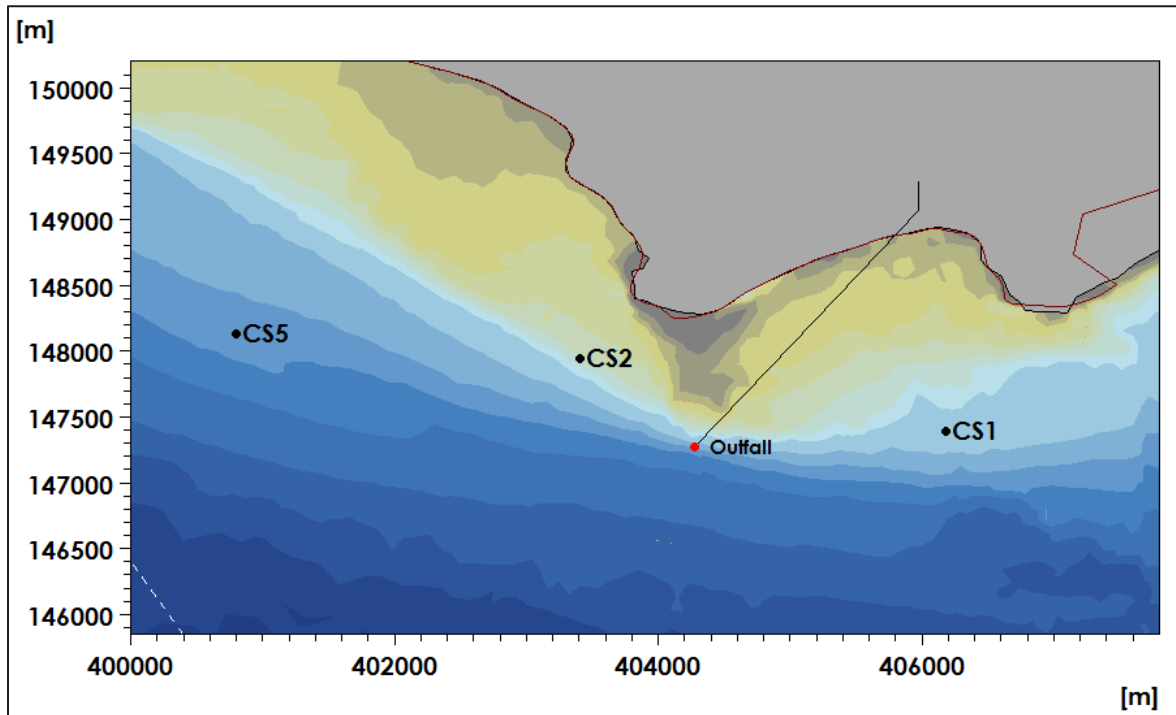


Figure 4-11 Location of the selected sampling stations.

Table 4-49: Comparison of water quality parameter concentration at location CS1, CS2 and CS5 with Class 3 MMWQS limit using measurement in 2012.



Parameters	Release concentration from outfall	Location	Ambient concentration (from measurement in 2012)	Maximum concentration from the model	Limit MMWQS for Class 3
Nitrate as NO ₃ [mg/l]	44	CS1	1.7	2.0	1
		CS2	1.6	2.5	
		CS5	1.6	1.8	
Phosphate as P [mg/l]	2	CS1	0.1	0.1	0.67
		CS2	0.1	0.1	
		CS5	0.1	0.1	
Total Suspended	30	CS1	13	13.3	100
		CS2	15	15.6	

Parameters	Release concentration from outfall	Location	Ambient concentration (from measurement in 2012)	Maximum concentration from the model	Limit MMWQS for Class 3
Solid (TSS) [mg/l]		CS5	12	12.1	
Oil and Grease	10	CS1	0.04	0.1	5
		CS2	0.04	0.2	
		CS5	0.04	0.1	
Total Nitrogen	10	CS1	0.5	0.6	NA
		CS2	0.6	0.8	
		CS5	0.5	0.5	
Ammonia	6.1	CS1	NA	NA	0.32
		CS2	NA	NA	
		CS5	NA	NA	
Phenol	0.2	CS1	NA	NA	0.1
		CS2	NA	NA	
		CS5	NA	NA	

Table 4-50: Comparison of water quality parameter concentration at location CS1, CS2 and CS5 with Class 3 MMWQS limit using measurement in 2016.



Parameters	Release concentration from outfall	Location	Ambient concentration (from measurement in 2016)	Maximum concentration from the model	Limit MMWQS for Class 3
Nitrate as NO ₃ [mg/l]	44	CS1	1.9	2.2	1
		CS2	1.8	2.7	
		CS5	1.6	1.8	
Phosphate as	2	CS1	0.1	0.1	0.67

Parameters	Release concentration from outfall	Location	Ambient concentration (from measurement in 2016)	Maximum concentration from the model	Limit MMWQS for Class 3
P [mg/l]		CS2	0.1	0.1	
		CS5	0.1	0.1	
Total Suspended Solid (TSS) [mg/l]	30	CS1	10	10.3	100
		CS2	11	11.6	
		CS5	17	17.1	
Oil and Grease	10	CS1	0.04	0.1	5
		CS2	0.04	0.2	
		CS5	0.04	0.1	
Total Nitrogen	10	CS1	0.5	0.6	NA
		CS2	0.5	0.7	
		CS5	0.5	0.5	
Ammonia	6.1	CS1	0.1	0.1	0.32
		CS2	0.1	0.2	
		CS5	0.1	0.1	
Phenol	0.2	CS1	0.001	0.002	0.1
		CS2	0.001	0.005	
		CS5	0.001	0.002	

	<p style="text-align: center;">ADDITIONAL INFORMATION TO THE DEIA REFINERY AND PETROCHEMICAL INTEGRATED DEVELOPMENT (RAPID) PROJECT, PENGERANG JOHOR, 2012 TO INCLUDE EURO 5 MOGAS AND OLEFIN TANK UNITS</p>	
	<p style="text-align: center;">CHAPTER 4 POTENTIAL ENVIRONMENTAL IMPACT AND MITIGATION MEASURES</p>	

4.3.4.4 Mitigating Measures

- a) Effluent Treatment Plant Discharge via Marine Outfall
- i. From the simulation conducted, results shows that the predicted maximum concentration of pollutant is less than 3% for all climatic conditions. The maximum concentration reduce quickly at area 5 km away the outfall area with an overall reduction of 97 percent. This shows that the water exchange at the outfall is expected to be good.
 - ii. The effluent treatment plant will also be designed to meet DOE's requirement for IETS which requires the incorporation of the continuous online monitoring of the wastewater treatment efficiency to meet the required standard at all time. Further to that, BAT and best practices will also considered in the design of the effluent treatment to avoid discharge of the effluent in concentration that may have an effect into the marine life and marine water quality.
 - iii. Routine monitoring by the regulatory agencies on the treatment performance and compliance to the discharged standards will be another means to ensure for compliance to effluent standard.
 - iv. Incorporation of various preventive and control measures will be incorporated during the project design stage as well as operational procedures to discharged effluent from impacting people, environment and asset. Among the control measures considered during the design stage are:
 - The regulatory requirements for compliance, PETRONAS Technical Code and Standards and applicable internal standards and guidelines;
 - Lesson learnt and adoption of the best practices based on other PETRONAS Operating Units or other similar plants globally;
 - Conduct of ENVID, HAZID and HAZOP at every critical progress of the design stage;
 - Carryout the effluent dispersion and simulations using acceptable simulation models to help in designing the

	<p style="text-align: center;">ADDITIONAL INFORMATION TO THE DEIA REFINERY AND PETROCHEMICAL INTEGRATED DEVELOPMENT (RAPID) PROJECT, PENGERANG JOHOR, 2012 TO INCLUDE EURO 5 MOGAS AND OLEFIN TANK UNITS</p>	
	<p style="text-align: center;">CHAPTER 4 POTENTIAL ENVIRONMENTAL IMPACT AND MITIGATION MEASURES</p>	

appropriate outfall locations, discharged temperature that verify no significant environmental impacts during when the plant is in operation;

- v. Among the control measures considered during the operational stage will be the incorporation of the followings in the design of the plants:
- Documented Operating Procedures to be adhered by the plants operators
 - Process Safety Management, Risk based inspection and asset life study
 - Structured maintenance program i.e. scheduled turnaround
 - Structures training program and competent operator to run the plants

RAPID design has taken into consideration all the possible failure scenario and the measures to contain from discharging pollutants to the environment. Among the measures which will be implemented to ensure the plant is operated safely and efficiently are as summarized in **Table 4-51**.



Table 4-51 Summary on the Preventive and Control Measures During the Design and Operation Stage for Discharged Effluent

No	Preventive and Control Measures		Details
DESIGN STAGE			
1.	Compliance to the regulatory requirements	Performance Monitoring and Process Control	<p>The performance monitoring programme that will be implemented at the ETP is in accordance with the Malaysian Department of Environment Technical Guidance on Performance Monitoring of Industrial Effluent Treatment System DOE-IETS-3. This includes the sampling location and frequency, determination of critical monitoring parameters and application of standard methods for analysis. The programme is also integrated with the process control system for proactive prevention of process failure ensuring the following:</p> <ul style="list-style-type: none"> • On-spec incoming effluent conditions, mitigating inlet fluctuations and failure risks; • Reliable performance of each process unit, adopting early detection and proactive failure prevention; and • On-spec treated effluent quality, adopting early detection for diversion of off-spec quality for re-treatment. <p>The performance monitoring and process control is automated as much as practicable. However there will be specific parameters and conditions when human interface is required as explained below.</p>
2.	Lesson Learnt from other similar Operating Units		Lesson Learnt and experience from other similar PETRONAS Operating Unit and outside company shall be incorporated in the project RAPID to prevent recurrence and this will be provided as early as in the design stage.
3.	Safeguarding Systems	Emergency Valves, Shut Down System, Automatic flow diversion, DCS Control	The ETP is designed with sufficient safeguarding features to ensure that it will be able to reliably treat effluents even during abnormal conditions that may occur either during normal operations or during shutdown/turnaround activities at the Complex.
4.	Monitoring Mechanism	Automation and On-Line Monitoring	<p>Instrumentations including automated valves, meters and on-line analysers are installed throughout the ETP at appropriate locations depending on the control requirements of each treatment process unit. Among the main instruments are:</p> <ul style="list-style-type: none"> • Flow meter • Level meter • DO meter • pH meter • Conductivity meter • TOC/COD analyser • Oil in water analyser • Sampler; etc. <p>The automation of the ETP process control and monitoring is controlled and recorded by the main Distributed Control System (DCS), with the data and command centre located at the main control room of the RAPID Complex.</p>



Table 4-51 Summary on the Preventive and Control Measures During the Design and Operation Stage for Discharged Effluent

No	Preventive and Control Measures	Details
OPERATION STAGE		
1.	Continuous Training Program	<p>Competent Operator</p> <p>The ETP is managed continuously by competent staff with sufficient effluent treatment experience in oil and gas industry. During operating conditions, the ETP shall be managed by the required number of staff.</p>
2.	Documentation on the Operating Procedures (OP)	<p>Written OP shall be made available during design stage. The instructions and operating procedures shall provide a clear guidance to operators for all plant operations scenarios which include normal, startup, shutdown as well as abnormal plant conditions. The operating procedures shall;</p> <ul style="list-style-type: none"> • Communicate the hazard and risk related to the activities described in the procedures as well as the required hazard and risk mitigations • Specify the relevant personnel to be competent in executing their tasks. • Be continuously reviewed and updated to ensure adequacy and effectiveness • Address the unit responsibilities, unique hazards, and the actual operating steps.
	Operating Procedures (OP) for Abnormal Operating Conditions	<p>Unusual flow characteristics from process unit/s that can cause high hydraulic and/or pollutant load or presence of unusual pollutant content at the ETP; and/or</p> <ul style="list-style-type: none"> • Each process unit that generates effluent stream to be treated at the ETP is required to provide a diversion tank to contain effluent that does not meet the receiving conditions of the ETP. The upset tank (located within the process unit battery limit) is able to hold the off-spec load to allow for either bleeding to the ETP in a controlled manner or trucking for treatment by other means i.e. thermal oxidation or third party facility (depending upon the characteristics of the effluent stream). • Should there be any breach of the unusual effluent into the ETP the stream will be diverted to an upset tank within the ETP battery limit. Similarly, this upset tank is able to contain the load to allow for either bleeding to the EQ Tank in a controlled manner or treatment by other means. • The diversion and bleeding of these upset streams are automatically controlled where practicable and is linked to the ETP main control system. These upset tanks are to be kept empty during normal operations so that there will always be available volume during an upset or emergency.
	Process upset or equipment failure (including power outages) at any of the units within the ETP.	<ul style="list-style-type: none"> • In the event of an upset or failure of a treatment unit, provisions are incorporated to allow for bypassing of the failed unit. Should the resultant effluent exceed the discharge limits, the off-spec stream will be diverted to the upset tank as explained above. This will allow for the poor quality effluent to be returned to the inlet of the ETP and re-treated. • An observation pond is installed before the discharge outlet. This is the final location where on-line monitoring is conducted before discharge. Shall there be any exceed to the limit the stream will be diverted to the upset tank for re-treatment. • The diversion and bleeding of these upset streams are automatically controlled and is linked to the ETP main control system.





Table 4-51 Summary on the Preventive and Control Measures During the Design and Operation Stage for Discharged Effluent

No	Preventive and Control Measures		Details
		Sparing Philosophy	<ul style="list-style-type: none"> The adopted sparing philosophy in the design of the ETP takes into account the need for maintenance and inspection, as well as flexibility for operation especially when the different process units within the RAPID Complex is shut down for repairs or maintenance, either individually or in groups. Depending on the criticality of the equipment and process units, between 50% to 100% redundancies are provided. Selected critical equipment is connected to the emergency power system to continue running even during power outage. Among the critical units and equipment are pumps, oil separators, equalization tank, DAF, biological treatment unit, air blowers and sludge dewatering.
		Human Interface and Manual Measurements	<p>There are specific parameters and decisions that require human's interface as input to the automated control. There will also be instances such as on-line measurement validation, control tuning, process optimisation and troubleshooting that will require manual measurements and specific human analysis and interventions. To allow for these analyses, operators are equipped with the necessary portable devices and kits that include the following:</p> <ul style="list-style-type: none"> DO Meter pH Meter Conductivity meter Sludge level meter Sampling kit COD Analyser Sludge Settling Kit Microscope; etc. <p>A mini laboratory is located within the ETP to allow for these analyses to be conducted within a controlled environment according to acceptable standard methods.</p> <p>Data and reports generated from all analyses will be recorded in a central information database. Selected data is integrated with the main DCS.</p>
		Preventive Maintenance	<p>Preventive maintenance programme are to be developed for critical units and equipment (including instrumentation). Necessary facilities are provided (including sparing as mentioned above) to allow for maintenance to be conducted without disruption to the treatment process. This will ensure that regular scheduled maintenance are carried out that will prevent unscheduled shutdown and failures of the treatment process.</p>
3.	Process Safety and Plant Reliability Management	Control & Instrumentation	<p>Control & Instrumentation will provide the first layer of protection from any deviations of operating variables from normal operating conditions.</p>



Table 4-51 Summary on the Preventive and Control Measures During the Design and Operation Stage for Discharged Effluent

No	Preventive and Control Measures		Details
		Reliability of instrumentation and control systems	<p>All parts critical to plant availability shall be designed and constructed so that:</p> <ul style="list-style-type: none">• Any single failure will not cause any safety issues and disrupt production• Defective components can be exchanged during operation without sacrificing plant safety or causing a plant shut down• Units that will not cause any safety issues and immediate shut down or where there is sufficient time for repair do not require a redundancy;• Testing shall be carried out in every turnaround to ensure the integrity of the safeguarding system.
		Laboratory Analysis	<ul style="list-style-type: none">• Analyses of monitoring parameters to determine the actual performance of each treatment unit will be conducted at the Central Laboratory within the RAPID Complex. The data will also be used for validation and quality assurance of the automation system. The frequency of sampling will be determined by the criticality of the parameters for performance monitoring.• Analysis of parameters for official reporting and regulatory compliance will be conducted by an accredited third party laboratory.• Data collected from all laboratory analyses will be recorded in a central laboratory information database that is integrated with the main DCS.

	<p style="text-align: center;">ADDITIONAL INFORMATION TO THE DEIA REFINERY AND PETROCHEMICAL INTEGRATED DEVELOPMENT (RAPID) PROJECT, PENERANG JOHOR, 2012 TO INCLUDE EURO 5 MOGAS AND OLEFIN TANK UNITS</p>	
	<p style="text-align: center;">CHAPTER 4 POTENTIAL ENVIRONMENTAL IMPACT AND MITIGATION MEASURES</p>	

4.3.5 QUANTITATIVE RISK ASSESSMENT (QRA)



4.3.5.1 Introduction

The objectives of the QRA study are to identify and quantify the probability and consequences of the possible accidents that may escalate from the proposed EURO 5 MOGAS units and its associated tank farms to the surrounding offsite areas; to calculate the level of risk; and to suggest measures to reduce the level of risk if higher than the allowable level in compliance with DOE's risk criteria stipulated in the Environmental Impact Assessment Guidelines for Risk Assessment, December 2004, EG 1/04.

4.3.5.2 Approach and Methodology

The risk assessment of the project has been conducted in accordance with the elements described in the following sections. The main stages of the QRA study are as follows:

- **Stage 1** - Hazard Identification: Identification of initiating release events and major hazards that require further evaluation;
- **Stage 2** - Frequency Analysis: Determination of the frequency of initiating events and the frequency of hazardous event outcomes;
- **Stage 3** - Consequence Analysis: Determination of the consequences of hazardous events;
- **Stage 4** - Event Tree Analysis: Representation of how the initiating event may develop and the resulting likelihood of the hazardous outcome;
- **Stage 5** - Risk Summation: Calculation of individual risk level and Evaluation as well as comparison against the risk criteria established for the study; and
- **Stage 6** - Risk Mitigation: Recommendation of risk mitigation measures, as required.

	<p style="text-align: center;">ADDITIONAL INFORMATION TO THE DEIA REFINERY AND PETROCHEMICAL INTEGRATED DEVELOPMENT (RAPID) PROJECT, PENGERANG JOHOR, 2012 TO INCLUDE EURO 5 MOGAS AND OLEFIN TANK UNITS</p>	
	<p style="text-align: center;">CHAPTER 4 POTENTIAL ENVIRONMENTAL IMPACT AND MITIGATION MEASURES</p>	

Further details of methodology of Quantitative Risk Assessment of this study is shown in **Volume 1, Chapter 3**.

4.3.5.3 Modeling Data Input

a) New EURO 5 MOGAS Units and Olefins Storage Tankages

Detailed assessment of the modeling data input for the quantitative risk assessment of the New EURO 5 MOGAS Units and Olefins Storage Tankages are shown in **Volume 2, Appendix 3**.



The events identified for further analysis in this study has been divided into isolatable section (which represent sections of the process that have various hold up inventory, pressure and temperature) as tabulated in **Volume 2, Appendix 3, Sub-Appendix 3A**. All consequence results can be found in **Volume 2, Appendix 3, Sub-Appendix 3B**, while the frequency results can be found in **Volume 2, Appendix 3, Sub-Appendix 3C**.

4.3.5.4 Findings

4.3.5.4.1 Risk Summation

The results of risk summation are presented in terms of Individual Risk which, in the context of the DOE Risk Guidelines, is defined as the risk of fatality to a person in the vicinity of a hazard. This includes the nature of the fatality to the individual, the likelihood of the fatality occurring, and the period of time over which the fatality might occur. The individual is assumed to be unprotected and to be present during the total time of exposure (i.e. 24 hours a day, every day of the year). The individual risk value, R_i at a particular distance, i , due to the occurrence of a particular event outcome, j , is calculated by the following equation:

$$R_i = \sum f_{eo,j} \cdot P_{fat,i,j} \cdot P_{weather,j}$$

	<p style="text-align: center;">ADDITIONAL INFORMATION TO THE DEIA REFINERY AND PETROCHEMICAL INTEGRATED DEVELOPMENT (RAPID) PROJECT, PENGERANG JOHOR, 2012 TO INCLUDE EURO 5 MOGAS AND OLEFIN TANK UNITS</p>	
	<p style="text-align: center;">CHAPTER 4 POTENTIAL ENVIRONMENTAL IMPACT AND MITIGATION MEASURES</p>	

where:

$f_{eo,j}$ is the frequency of event outcome j obtained from event tree analysis and historical data;

$P_{fat,i,j}$ is the probability of fatality at distance i produced by event outcome j from consequence analysis; and

$P_{weather,j}$ is the probability of the weather conditions required to produce the event outcome at j (from meteorological data, 1 for weather independent event outcomes).

The individual risk (IR) profile for the site under study is calculated with the Consultant's in-house spreadsheet based on the above equation. It is represented as a function of distance from the source of potential risk upon the surrounding environment. Risk summation involves combining the frequency of a given event outcome j with its associated consequences to determine the individual risk levels associated with the site.

4.3.5.4.2 Salient Findings of the EURO MOGAS and Olefin Storage Tank QRA Study

The extent of all consequences assessed is limited within the industrial development surrounding the proposed RAPID facilities, which is in compliance with DOE's risk acceptance criteria.

- That the following hazard zones/ IR contour for credible scenarios are within RAPID boundary;
 - 37.5 kW/m² heat radiation hazard zone; and
 - The 1.013 bar overpressure contour.

- IR Contours:
 - The 1 x 10⁻⁵ per year and the 1 x 10⁻⁶ per year IR contours extends beyond the RAPID Complex development boundary,

encroaching the neighboring development on the southern side of the RAPID Complex.



The above results are in compliance of the requirements stipulated by the DOE risk criteria as no sensitive receptors (schools, residential areas) are affected.

Table 4-52: Individual Risk (IR) Contour Findings Summary for EURO 5 MOGAS Units and Olefins Storage Tankages

IR Contours	Max Distance to Contour (m)	Confirmation
1 × 10 ⁻⁵ per year	703.10	The contour extends beyond RAPID's site boundary, encroaching the neighboring development on the southern side of the RAPID Complex. However it does not encompass involuntary recipients of industrial risks to sensitive receptors i.e. schools and residential areas.
1 × 10 ⁻⁶ per year	955.70	The contour extends beyond RAPID's site boundary, encroaching the neighboring development on the southern side of the RAPID Complex. However it does not encompass involuntary recipients of industrial risks to sensitive receptors i.e. schools and residential areas.

The Individual Risk Contour for the EURO 5 MOGAS Units and Olefins Storage Tankages is attached in **Volume 2, Appendix 3, Sub-Appendix 3D**.

It should be noted that the risks have been assessed on a conservative basis, both in terms of consequences (e.g. use of the maximum inventories of hazardous substances in vessels, worst case process conditions, releases are modelled based on initial maximum (rather than average) release rates, no account taken of site drainage/ emergency spill containment systems to limit the spread of liquid releases etc. using published computer models that



	<p style="text-align: center;">ADDITIONAL INFORMATION TO THE DEIA REFINERY AND PETROCHEMICAL INTEGRATED DEVELOPMENT (RAPID) PROJECT, PENGERANG JOHOR, 2012 TO INCLUDE EURO 5 MOGAS AND OLEFIN TANK UNITS</p>	
	<p style="text-align: center;">CHAPTER 4 POTENTIAL ENVIRONMENTAL IMPACT AND MITIGATION MEASURES</p>	

are inherently conservative), and frequency – i.e. no account has been taken of plant safety systems (e.g. isolation valves, detectors), operator intervention to prevent or minimise releases and no credit has been taken to account for the site Safety Management System.

A worst case scenario (WCS) is the scenario which entails the farthest consequence distance amongst all the scenarios irrespective of the frequency while a worst case credible scenario (WCCS) is a credible scenario (with event frequencies $> 1 \times 10^{-6}$ per year) with furthest consequence distance.

Below explains the WCS and WCCS for each event from the QRA study for the Euro 5 MOGAS Plant and its associated tank farm and Olefin Storage Tank Farm:

- The WCS and WCCS of fire event is a jet fire scenario resulting from the ignited release of Ethylene (at a rate of 2222.85 kg/s) due to a catastrophic release from the HP Ethylene BOG Liquid Receiver (5220-V-102) at -114 °C and 47 barg pressure. This results in the 37.5 kW/m² heat radiation hazard zone (that corresponds to a radiation intensity sufficient to cause up to 100% fatalities and damage process equipment) of up to 614.87 m. The 4 kW/m² heat radiation hazard zone (that typically corresponds to a radiation intensity to cause up to 3% fatalities and below which no injuries or damage would be expected) extends a maximum of 877.30 m confined within the proposed RAPID project boundary. Refer to **Figure E1** at **Volume 2, Appendix 3, Sub-Appendix 3E** for the WCS and WCCS contour of fire event.
- The WCS and WCCS of explosion event originate from the Boiling Liquid Expanding Vapour Explosion (BLEVE) due to a catastrophic release of Propylene from the Propylene Storage Vessel (5220-V-104) which operates at 40 °C and 15.5 barg pressure. This result in the 1.013 bar explosion overpressure hazard zone (where extensive damage and fatalities are to be expected) extends up to 79.95 m

	<p style="text-align: center;">ADDITIONAL INFORMATION TO THE DEIA REFINERY AND PETROCHEMICAL INTEGRATED DEVELOPMENT (RAPID) PROJECT, PENGERANG JOHOR, 2012 TO INCLUDE EURO 5 MOGAS AND OLEFIN TANK UNITS</p>	
	<p style="text-align: center;">CHAPTER 4 POTENTIAL ENVIRONMENTAL IMPACT AND MITIGATION MEASURES</p>	

which is confined to the RAPID site boundary. Refer to **Figure E2** at **Volume 2, Appendix 3, Sub-Appendix 3E** for the WCS and WCCS contour of explosion event.

- The WCS and WCCS of fireball event originate from the Boiling Liquid Expanding Vapour Explosion (BLEVE) due to a catastrophic release of Propylene from the Propylene Storage Vessel (5220-V-104) which operates at 40 °C and 15.5 barg pressure. This result in 100% fatality distance of up to 124.88 m and 3% fatality distance of up to 685.75 m, which remains within the RAPID site. Refer to **Figure E3** at **Volume 2, Appendix 3, Sub-Appendix 3E** for the WCS and WCCS contour of fireball event.



4.3.5.4.3 Cumulative Assessment – Refinery Cracker Complex

The cumulative assessment of the entire Refinery Cracker Complex (inclusive of the latest addition of the EURO MOGAS and Olefin Storage Tanks) demonstrates that the individual risk contours for the complex are not in line with DOE’s risk acceptance criteria. This is mainly due to the catastrophic failure events within the refinery units which result in offsite consequences and subsequently unacceptable risk towards the surrounding present population.

The contributing events that results in the unacceptable risk are:

1. Flash Fire event due to catastrophic failures of equipment in 2 Trains of Residue Fluid Catalytic Cracking Unit.
2. Fire events related to catastrophic failure of Intermediate LPG storage vessels of the Refinery Storage Tank Farm.

The cumulative individual risk contour for the Refinery Cracker Complex is provided in **Volume 2, Sub-Appendix 3D**. The worst case scenario consequence contours are provided in **Volume 2, Sub-Appendix 3G**. Recommendation for the residual risk is discussed in **Section 4.3.3.5**.

	<p style="text-align: center;">ADDITIONAL INFORMATION TO THE DEIA REFINERY AND PETROCHEMICAL INTEGRATED DEVELOPMENT (RAPID) PROJECT, PENGERANG JOHOR, 2012 TO INCLUDE EURO 5 MOGAS AND OLEFIN TANK UNITS</p>	
	<p style="text-align: center;">CHAPTER 4 POTENTIAL ENVIRONMENTAL IMPACT AND MITIGATION MEASURES</p>	

4.3.5.4.4 Cumulative Assessment – Refinery Cracker Complex and Petrochemical Complex

The cumulative assessment of the entire RAPID Complex (inclusive of the Refinery Cracker Complex and Petrochemical Complex) demonstrates that the individual risk contours for the complex are not in line with DOE's risk acceptance criteria. The main risk contributor towards the non-compliance are the catastrophic failure events within the refinery units which result in offsite consequences and subsequently unacceptable risk towards the surrounding present population.



Risk from the Petrochemical Complex is deemed not to be the contributing factor in resulting non-compliance of DOE's risk acceptance criteria.

The cumulative individual risk contour for the entire RAPID Complex is provided in **Volume 2, Sub-Appendix 3D**. The worst case scenario consequence contours are provided in **Volume 2, Appendix 3, Sub-Appendix 3F and 3G**.

4.3.5.5 Recommendations

Taking into consideration that the contributing events towards the project's non-compliance in meeting DOE's risk acceptance criteria are due to catastrophic failures, the operators of the refinery shall implement the "Predictive Maintenance" programme to eliminate catastrophic equipment failures.

- The Predictive Maintenance philosophy consists of scheduling maintenance activities only if and when mechanical or operational conditions warrant-by periodically monitoring the machinery for excessive vibration, temperature and/or lubrication degradation, or by observing any other unhealthy trends that occur over time. When the condition gets to a predetermined unacceptable level, the equipment is



	ADDITIONAL INFORMATION TO THE DEIA REFINERY AND PETROCHEMICAL INTEGRATED DEVELOPMENT (RAPID) PROJECT, PENGERANG JOHOR, 2012 TO INCLUDE EURO 5 MOGAS AND OLEFIN TANK UNITS	
	CHAPTER 4 POTENTIAL ENVIRONMENTAL IMPACT AND MITIGATION MEASURES	

shut down to repair or replace damaged components so as to prevent a more costly failure from occurring.

Advantages of this approach are that it works very well if personnel have adequate knowledge, skills, and time to perform the predictive maintenance work, and that it allows equipment repairs to be scheduled in an orderly fashion. It also provides some lead-time to purchase materials for the necessary repairs, reducing the need for a high parts inventory. Since maintenance work is only performed when it is needed, there is likely to be an increase in production capacity. The predictive maintenance programme shall form part of PETRONAS's Process Safety Management Framework.

Other recommendations for the project proponent are as follows:

- Development of a formal framework for managing health, occupational safety, environment and process safety matters. Emphasis should be given to Process safety management as an analytical tool focused on preventing releases of any substance defined as a "highly hazardous chemicals". It is a set of inter-related approaches to manage hazards associated with the process industries and is intended to reduce the frequency and severity of incidents resulting from releases of chemicals and other energy sources.
- Design changes during the subsequent engineering phases post EIA should be analysed to determine the severity of the potential hazards (via safety studies) due to the proposed changes. The revised risk levels shall be in line with the governing risk criteria adopted by DOE.
- Development of an Emergency Response Plan is essential to manage emergencies within the proposed RAPID boundary. This is in line with the approval conditions obtained during the approval of the RAPID DEIA in 2012 (Approval Conditions 61 and 62).

	ADDITIONAL INFORMATION TO THE DEIA REFINERY AND PETROCHEMICAL INTEGRATED DEVELOPMENT (RAPID) PROJECT, PENERANG JOHOR, 2012 TO INCLUDE EURO 5 MOGAS AND OLEFIN TANK UNITS	
	CHAPTER 4 POTENTIAL ENVIRONMENTAL IMPACT AND MITIGATION MEASURES	

This plan shall address the following key elements:



- Alerting - Notifying the offsite population that are affected or exposed to risk greater than 1E-06 fatality per year. An effective alarm and warning system for all levels of emergency shall be established and regularly tested.
- Evacuation - Evacuation of the potentially exposed public
- Sheltering - Provision of shelter for the evacuated public population

The role, duties and responsibility of the person(s) initiating the off-site warning system should be defined. The plan should identify the means by which the facility operator will warn (and keep informed) people likely to be affected by the emergency. This should cover the activation of the warning system to alert people to take protective action. The key step is to determine when there is a threat to the community.

The evacuation of people outside the facility and the control of public roads, pedestrians and vehicles is the responsibility of the Police. Procedures should be established for liaison with the Police and Fire Services and for the provision of information that will assist in making decisions regarding public protection issues.



The plan should identify the facility's strategy for protecting people during an emergency. It should address the provision of advice to people on-site and off-site as to the appropriate action to be taken when there is a threat to their health and safety. This function is responsible for ensuring that this information is communicated and acted upon during an emergency, prior to the arrival of the emergency services.

Protective actions may include stand-by alerts, partial evacuations, full evacuation, or the use of shelters and havens. The actions taken will

	<p align="center">ADDITIONAL INFORMATION TO THE DEIA REFINERY AND PETROCHEMICAL INTEGRATED DEVELOPMENT (RAPID) PROJECT, PENGERANG JOHOR, 2012 TO INCLUDE EURO 5 MOGAS AND OLEFIN TANK UNITS</p>	
	<p align="center">CHAPTER 4 POTENTIAL ENVIRONMENTAL IMPACT AND MITIGATION MEASURES</p>	

depend on the nature, scale and the likely duration of the emergency. Appropriate methods of protection may be determined by reference to the levels of emergency and the control zones for various emergencies.

The proposed facility is deemed to be a Major Hazard Installation, in compliance to the CIMAH Regulations 1996, a safety report and emergency response plan shall be prepared and submitted to the Department of Occupational Safety and Health's Major Hazard Division 3 months prior to commissioning.

	<p align="center">ADDITIONAL INFORMATION TO THE DEIA REFINERY AND PETROCHEMICAL INTEGRATED DEVELOPMENT (RAPID) PROJECT, PENGERANG JOHOR, 2012 TO INCLUDE EURO 5 MOGAS AND OLEFIN TANK UNITS</p>	
	<p align="center">CHAPTER 4 POTENTIAL ENVIRONMENTAL IMPACT AND MITIGATION MEASURES</p>	

4.3.6 WASTE MANAGEMENT

4.3.6.1 Introduction



The Waste Management Study under this report will highlight the schedule waste management to be adopted for the EURO 5 MOGAS Units and Olefins Storage Tankages upon operation. This will include the generation, handling, storage and disposal of the waste. The study scope shall only be limited to management of the scheduled wastes generated from the operations at the EURO 5 MOGAS and Olefins Storage Tankages in the process area.

The domestic and non-scheduled waste shall not be included as this report as these type of waste will be generated outside of the Refinery and Cracker Complex areas, at the centralized Administration Building located at the northeast of the RAPID complex. All of the domestic and non-scheduled waste generated from the main Administration and Control Building will be stored in the vicinity of the buildings for easy removal by the licensed contractor.

4.3.6.1.1 Review Of Legislative Requirements And Guidelines

The development of the waste handling and management study will be guided by the relevant legislative requirements and guidelines. A list of key legislation and guidelines are provided below:

- a) Environmental Quality Act 1974 – Act 127
- b) Solid Waste and Public Cleansing Management Act 2007
- c) Environmental Quality (Scheduled Waste) Regulations, 2005 (Amendment 2007)
- d) Environmental Quality (Prescribed Premises) (Scheduled Waste Treatment and Disposal Facilities) Regulations, 1989 (Amendment 2006)
- e) Environmental Quality (Prescribed Conveyance) (Scheduled Waste) Order, 2005

	ADDITIONAL INFORMATION TO THE DEIA REFINERY AND PETROCHEMICAL INTEGRATED DEVELOPMENT (RAPID) PROJECT, PENGERANG JOHOR, 2012 TO INCLUDE EURO 5 MOGAS AND OLEFIN TANK UNITS	
	CHAPTER 4 POTENTIAL ENVIRONMENTAL IMPACT AND MITIGATION MEASURES	

- f) Guidelines for Packaging, Labelling and Storage of Scheduled Wastes in Malaysia 2014

4.3.6.2 Waste Management Philosophy



In RAPID DEIA 2012, the RAPID Complex operating philosophy is such that all of the waste generated from the RAPID Complex is to be sent and managed at the centralised waste management facility in RAPID Complex known as RAPID Resource and Recovery Facility (RRF). The proposed facility will collect, store and treat the waste from the transit and temporary storages located in the operating plants with the objective to reduce the schedule waste volume for disposal at licensed schedule waste disposal facility.

Due to the revised number of the petrochemical plants, the waste volume to be sent to the RAPID Resource and Recovery Facility (RRF) had decreased significantly hence does not provide the economics for the RAPID Resource and Recovery Facility (RRF) to be constructed in RAPID. Hence, each of the operating plants in RAPID Complex including the Refinery and Cracker Complex has to manage their own waste and the waste is to be stored within their operating premise prior to disposal by licensed schedule waste operator.

The propose schedule waste segregation at the schedule waste storage area shall be by the following type of wastes so as to ensure waste compatibility and that they do not react with each other causing safety concerns:

Table 4-53: Proposed SW Segregation at the Schedule Waste Storage

Cell No	Category of Waste
Cell No. 1	Toxic (Solid)
Cell No. 2	Corrosive (Solid)
Cell No. 3	Combustible (Liquid)
Cell No. 4	Combustible (Solid)
Cell No. 5	Flammable (Solid + Liquid)
Cell No. 6	Toxic Liquid

	<p style="text-align: center;">ADDITIONAL INFORMATION TO THE DEIA REFINERY AND PETROCHEMICAL INTEGRATED DEVELOPMENT (RAPID) PROJECT, PENGERANG JOHOR, 2012 TO INCLUDE EURO 5 MOGAS AND OLEFIN TANK UNITS</p>	
	<p style="text-align: center;">CHAPTER 4 POTENTIAL ENVIRONMENTAL IMPACT AND MITIGATION MEASURES</p>	

The scheduled waste volume which will be generated continuously at frequency of less than a year (daily, weekly, monthly, quarterly and once in 6 months) will be taken as the basis of waste storage area sizing. Waste storage area design is also limited by DOE's requirement for storage to be 20 tonnes or less or 180 days storage, whichever is first. In the event where DOE storage requirements are exhausted, the waste need to be removed on a more frequent basis.

Schedule waste generated from turn around or scheduled maintenance activities is not considered for the sizing of the schedule waste storage. These waste will be managed separately during the plant turnaround or scheduled maintenance.

The typical layout of the proposed scheduled waste storage and the allocation of cells for the waste separation is as in **Figure 4-12**. The location of the main scheduled waste storage for the Refinery and Cracker Complex shall be at location indicated in **Figure 4-13** near to the Sulphur Solidification Unit (SSU). All of the scheduled waste generated from the EURO 5 MOGAS unit, Olefin Storage Tank and other Refinery Cracker Units shall be sent to this location for collection and disposal by a DOE licensed 3rd party scheduled waste operator.



CHAPTER 4
POTENTIAL ENVIRONMENTAL IMPACT AND MITIGATION MEASURES

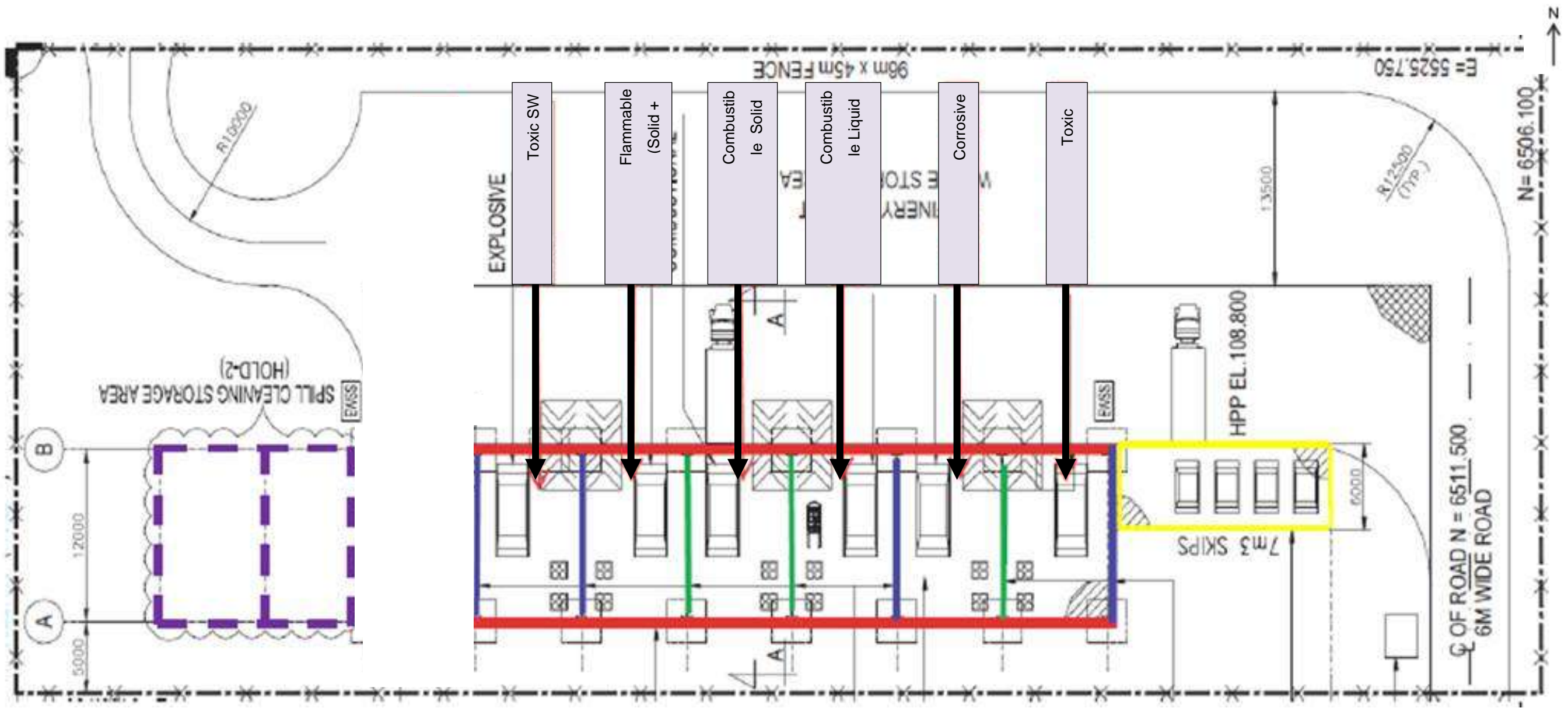


Figure 4-12: Proposed Schedule Waste Storage Area Layout Design

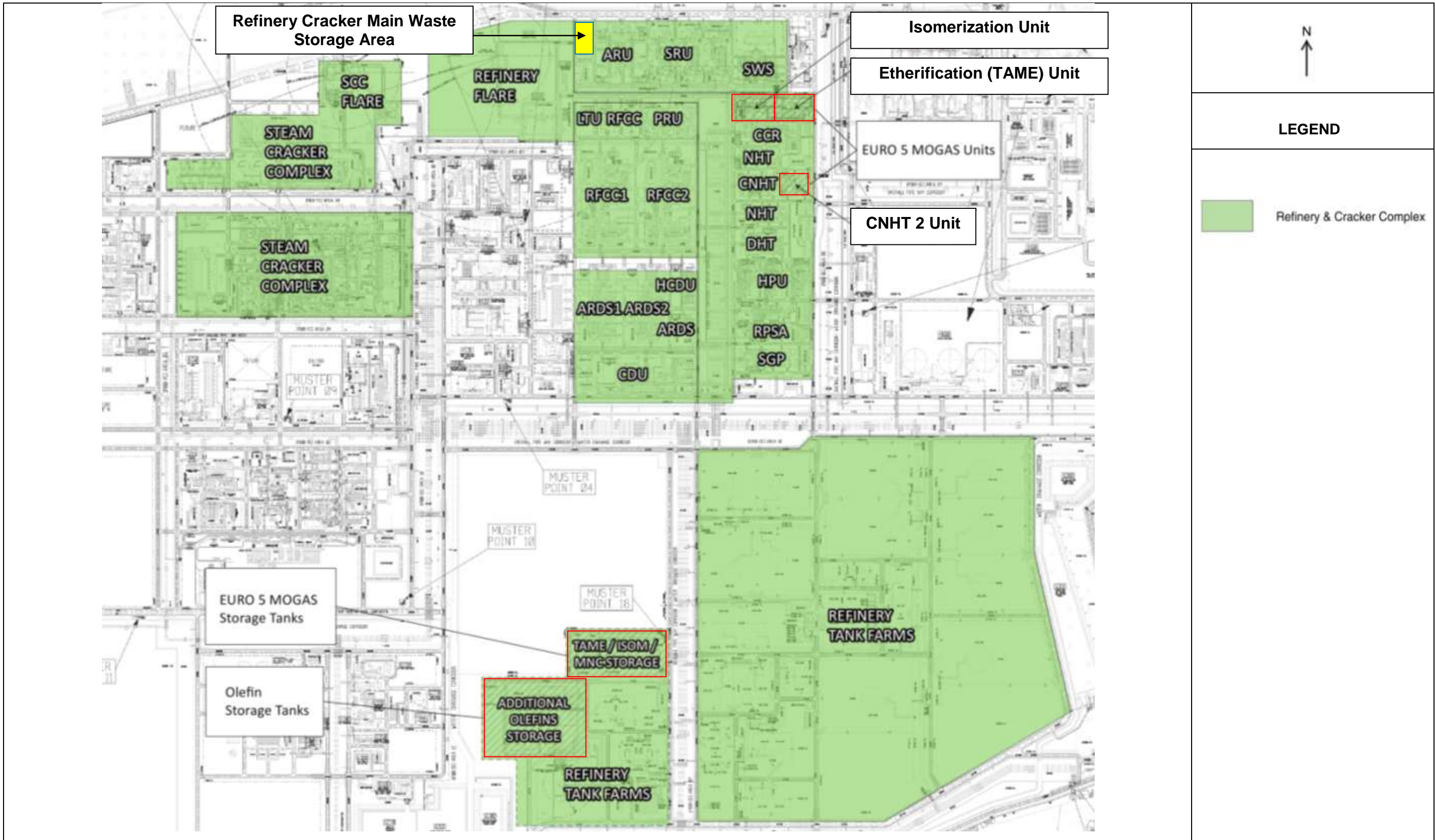




Figure 4-13: Refinery Cracker Complex Main Waste Storage Area

	<p style="text-align: center;">ADDITIONAL INFORMATION TO THE DEIA REFINERY AND PETROCHEMICAL INTEGRATED DEVELOPMENT (RAPID) PROJECT, PENGERANG JOHOR, 2012 TO INCLUDE EURO 5 MOGAS AND OLEFIN TANK UNITS</p>	
	<p style="text-align: center;">CHAPTER 4 POTENTIAL ENVIRONMENTAL IMPACT AND MITIGATION MEASURES</p>	

4.3.6.3 Scheduled Waste Generation

The scheduled waste inventory for EURO 5 MOGAS Units are shown in **Table 4-54** and

Table 4-55. For the Olefins Storage Tankages, the scheduled waste generated is expected only during turnaround and tank maintenance where tank cleaning are carried out. Schedule waste during the maintenance and turnaround is not to be stored in the Refinery Main Waste Storage Area and to be managed separately.

With the current waste management philosophy adopted in the Refinery and Cracker Complex, the amount of scheduled waste generated is estimated to be approximately **7,562.8 tonnes per year** during the normal operation while approximately **4,723.7 tonnes** will be generated during the turn around and scheduled maintenance activities. Based on **Table 4-56** and **Table 4-57**, the current estimation of scheduled waste's amount to be generated from Refinery & Cracker Complex during normal operation is higher compared to the estimation in RAPID DEIA 2012. This is contributed by the change of RAPID Waste Management Philosophy from having a RAPID centralized waste management centre to each of the operating plants in RAPID Complex has to manage their own waste and waste to be stored within their operating premise prior to disposal by licensed schedule waste operator.

With the establishment of waste handling and management procedures and controls, impacts from waste storage, transfer, handling, transport and disposal are not expected to be significant. Furthermore, groundwater and soil monitoring should be conducted periodically at the individual units to ensure that no contamination of groundwater has occurred during the operations of the plant.



Table 4-54: Scheduled Waste Inventory for Isomerization Unit

No	Source	Description of Scheduled Waste Scheduled	Waste Code Scheduled Waste Category as per First Schedule, Regulation 2, Environmental Quality (SW) Regulations 2005	Estimated Quantity (metric tonne, MT)	Frequency of generation		Packaging	Final Destination
					Normal operation	Turnaround and Schedule Maintenance		
1	Sulfur Guard Bed	Ceramic Balls 1/4"	SW 409	0.00046		4 years	Container/Drum	DOE Licensed Scheduled Waste Facility
2	Sulfur Guard Bed	Molecular Sieves	SW 409	6.417		3 years	Container/Drum	
3	Sulfur Guard Bed	Ceramic Balls 1/4"	SW 409	0.00056		4 years	Container/Drum	
4	Feed Dryers	Molecular Sieves	SW 409	6.417		3 years	Container/Drum	
5	Feed Dryers	Ceramic Balls 1/4"	SW 409	0.00056		4 years	Container/Drum	
6	H2 Purification Reactor	First layer Membrane	SW 409	1.015		5 years	Container/Drum	
7	H2 Purification Reactor	Second layer Membrane	SW 409	0.00133		5 years	Container/Drum	
8	H2 Purification Reactor	Ceramic Balls 1/4"	SW 409	0.00032		4 years	Container/Drum	DOE Licensed Scheduled Waste Facility
9	Hydrogen Dryers	Molecular Sieves	SW 409	0.00250		3 years	Container/Drum	
10	Hydrogen Dryers	Ceramic Balls 1/4"	SW 409	0.00012		4 years	Container/Drum	
11	Hydrogen Dryers	Molecular Sieves	SW 409	0.00250		3 years	Container/Drum	
12	Hydrogen Dryers	Ceramic Balls 1/4"	SW 409	0.00012		4 years	Container/Drum	
13	Chloride Guard Bed	Spent Catalyst	SW202	6.417		3 years	Container/Drum	
14	Chloride Guard Bed	Ceramic Balls 1/4"	SW 409	0.00060		4 years	Container/Drum	



CHAPTER 4
POTENTIAL ENVIRONMENTAL IMPACT AND MITIGATION MEASURES

No	Source	Description of Scheduled Waste Scheduled	Waste Code Scheduled Waste Category as per First Schedule, Regulation 2, Environmental Quality (SW) Regulations 2005	Estimated Quantity (metric tonne, MT)	Frequency of generation		Packaging	Final Destination
					Normal operation	Turnaround and Schedule Maintenance		
15	2 nd ISOM Reactor	Spent Catalyst	SW202	0.02060		4 years	Container/Drum	DOE Licensed Scheduled Waste Facility
16	2 nd ISOM Reactor	Ceramic Balls 1/4"	SW 409	0.00068		4 years	Container/Drum	
17	2 nd ISOM Reactor	Spent Catalyst	SW202	0.02060		4 years	Container/Drum	
18	2 nd ISOM Reactor	Ceramic Balls 1/4"	SW 409	TBC		4 years	Container/Drum	
19	Caustic Scrubber	Spent Support Material	SW411	1.4m ³		5 years	TBC	
Total Estimated Quantity (During Turnaround & Scheduled Maintenance)						Approximately 20.31 Tonnes		

Table 4-55: Scheduled waste Inventory for Etherification TAME Unit

No	Source	Description of Scheduled Waste Scheduled	Waste Code Scheduled Waste Category as per First Schedule, Regulation 2, Environmental Quality (SW) Regulations 2005	Estimated Quantity (Metric Tonne, MT)	Frequency of generation		Packaging	Final Destination
					Normal operation	Turnaround and Schedule Maintenance		
1	First reactor	Catalyst bed (Sulfonic acid resin/amberlyst)	SW202	110.88		18month	TBC	DOE Licensed Scheduled Waste Facility
2	Feed filter	Catridge filter (Polyproplene cartridge 99% +1% oil)	SW410	TBC	TBC		TBC	
3	Feed filter	Catridge filter (Polyproplene cartridge 99% +1% oil)	SW410	TBC	TBC		TBC	
5	First reactor resin filter	Cartridge Filter	SW410	TBC	TBC		TBC	





CHAPTER 4
POTENTIAL ENVIRONMENTAL IMPACT AND MITIGATION MEASURES

No	Source	Description of Scheduled Waste Scheduled	Waste Code Scheduled Waste Category as per First Schedule, Regulation 2, Environmental Quality (SW) Regulations 2005	Estimated Quantity (Metric Tonne, MT)	Frequency of generation		Packaging	Final Destination	
					Normal operation	Turnaround and Schedule Maintenance			
6	First reactor resin filter	Cartridge Filter	SW410	TBC	TBC		TBC		
7	Second reactor filter	Cartridge Filter	SW410	TBC	TBC		TBC		
8	Second reactor filter	Cartridge Filter	SW410	TBC	TBC		TBC		
9	Second reactor	Catalyst Bed	SW202	110.88		2 years	Sealed drum		
10	Third reactor resin filter	Cartridge Filter	SW410	TBC	TBC		TBC		DOE Licensed Scheduled Waste Facility
11	Third reactor resin trap	Cartridge Filter	SW410	TBC	TBC		TBC		
12	Third reactor	Catalyst Bed	SW202	TBC	TBC		Sealed drum		
13	Third reactor resin filter	Cartridge filter with carbon steel (Polyphenylene Sulphide)	SW410	TBC	TBC		TBC		
14	Third reactor resin filter	Cartridge filter with carbon steel (Polyphenylene Sulphide)	SW410	TBC	TBC		TBC		DOE Licensed Scheduled Waste Facility
15	Methanol Guard Pots	Catalyst Bed	SW202	1.771		Every year	Sealed drum		
16	Methanol Guard Pots	Catalyst Bed	SW202	1.771		Every year	Sealed drum		
17	Methanol Guard filter	Catalyst Bed	SW202	5m ³		Every year	Sealed drum		
18	Methanol Guard filter	Catalyst Bed	SW202	5m ³		Every year	Sealed drum		
Total Estimated Quantity (During Turnaround & Scheduled Maintenance)					Approximately 225.302 Tonnes				

Table 4-56: Estimated Amount of SW Generated from Units in Refinery and Cracker Complex

No	Units	RAPID DEIA 2012		Current Refinery Cracker Complex	
		Normal Operation (tonnes/year)	Scheduled Maintenance and Turnaround (tonnes)	Normal Operation (tonnes/year)	Scheduled Maintenance and Turnaround (tonnes)
1	Residue Fluidized Cracker Unit (RFCC)	-	-	7562.8	6.11
2	LPG Treating Unit (LTU)	-	-	-	7.6
3	Atmospheric Residue Desulphurization (ARDS)	-	-	-	3089.6
4	Crude Distillation Unit (CDU)	-	-	-	0.0001
5	Operator Shelter Building (OSB) - Common Area nearby CDU	-	-	-	0.065
6	Saturated Gas Plant (SGP)	-	-	-	0.55
7	Diesel Hydrotreating (DHT)	-	-	-	24.08
8	Kerosene Hydrotreating (KHT)	1.0185	-	-	3.29
9	Cracker Naphtha Hydrotreating Unit (CNHT)	-	-	-	31.74
10	Naphtha Hydrotreating Unit (NHT)	-	-	-	6.34
11	Continuous Catalytic Reformer Unit (CCR)	-	-	-	67.18
12	Hydrogen Production Unit (HPU)	-	-	-	57.47
13	Amine Regeneration Unit (ARU)	-	-	-	165.45
14	Sulphur Recovery Unit (SRU)	-	-	-	523.14
15	Sour Water Stripping Unit (SWS)	-	-	-	17.72
16	Hydrogen Collection and Distribution Unit (HCDU)	-	-	-	-
17	Refinery Pressure Swing Adsorption	-	-	-	-
18	Refinery Tank Farm	-	-	-	472.95



	ADDITIONAL INFORMATION TO THE DEIA REFINERY AND PETROCHEMICAL INTEGRATED DEVELOPMENT (RAPID) PROJECT, PENGERANG JOHOR, 2012 TO INCLUDE EURO 5 MOGAS AND OLEFIN TANK UNITS	
	CHAPTER 4 POTENTIAL ENVIRONMENTAL IMPACT AND MITIGATION MEASURES	

No	Units	RAPID DEIA 2012		Current Refinery Cracker Complex	
		Normal Operation (tonnes/year)	Scheduled Maintenance and Turnaround (tonnes)	Normal Operation (tonnes/year)	Scheduled Maintenance and Turnaround (tonnes)
19	Olefins Storage Tankages	-	-	-	-
20	Additional EURO 5 MOGAS Storages	-	-	-	-
21	2nd Stage Cracked Naphtha Hydrotreating (CNHT) Unit	-	-	-	-
22	C5/C6 Isomerization Unit	-	-	-	20.31
23	Etherification Unit Tertiary-Amyl-Methyl-Ether (TAME)	-	-	-	225.302
24	Steam Cracker Complex (SCC)	-	-	-	4.77
TOTAL		1.0185	-	7562.8	4,723.7

Table 4-57: Estimated Amount of SW Generated from Refinery and Cracker

Complex	RAPID DEIA 2012		Current Refinery Cracker Complex	
	Normal Operation	Scheduled Maintenance and Turnaround	Normal Operation	Scheduled Maintenance and Turnaround
Refinery Complex	1.0185 tonnes per year	-	7562.8 tonnes per year	4,723.7 tonnes
Steam Cracker Complex	Fully recovered	-		

Note: Some of the amount of SW generated is yet to be determine at this stage. The details of the SW list are provided in the inventory list.

	<p style="text-align: center;">ADDITIONAL INFORMATION TO THE DEIA REFINERY AND PETROCHEMICAL INTEGRATED DEVELOPMENT (RAPID) PROJECT, PENGERANG JOHOR, 2012 TO INCLUDE EURO 5 MOGAS AND OLEFIN TANK UNITS</p>	
	<p style="text-align: center;">CHAPTER 4 POTENTIAL ENVIRONMENTAL IMPACT AND MITIGATION MEASURES</p>	

4.3.6.4 Impact Assessment And Mitigation Measures

Impacts from EURO 5 MOGAS and Olefin Tank Units were assessed for the operations phase of the Project development. The impact during construction and decommissioning has been discussed in RAPID DEIA 2012 and remain unchanged.

4.3.6.4.1 Potential Impact

During the plant operational, it will involve daily storage, handling, transport and disposal of various types of wastes which any accidental spillage may impact the quality of the surface water, marine water and soil and groundwater. To some extent, the reactivity of the toxic and hazardous waste to be managed may cause worker's and community safety and health impact.



From the assessment of the RAPID Complex design philosophy, the impacts associated with the storage, transfer, handling, transport and disposal of the scheduled wastes during operational phase is expected to be minor and mostly contained from impacting the surrounding environment.

4.3.6.4.2 Mitigation Measures

The mitigation measures proposed to minimise the impacts to the environment from waste management during the operations phase in terms of waste handling practices are provided in the following sections:

4.3.6.4.2.1 Scheduled Wastes Storage Requirements

- a) The storage area shall be sheltered to prevent any intrusion from rainfall and to contained and flammable and explosion within the cell without spreading to the next cell via a firewall design.
- b) Adequate ventilation shall be provided where volatile wastes are stored.

	ADDITIONAL INFORMATION TO THE DEIA REFINERY AND PETROCHEMICAL INTEGRATED DEVELOPMENT (RAPID) PROJECT, PENERANG JOHOR, 2012 TO INCLUDE EURO 5 MOGAS AND OLEFIN TANK UNITS	
	CHAPTER 4 POTENTIAL ENVIRONMENTAL IMPACT AND MITIGATION MEASURES	

- c) Appropriate bins/skips should be provided at suitable locations in the storage area.
- d) Adequate access to be provided to ensure easy manoeuvrability of the trucks to remove the schedule waste by licensed operator.

4.3.6.4.2.2 Segregation between incompatible scheduled wastes



- a) Waste shall be stored in a manner that prevents the mixing or contact between incompatible wastes, and allows for inspection between containers to monitor leaks or spills (e.g. sufficient space or physical separation such as walls or containment curbs between incompatible wastes).
- b) Flammable substances must be kept separate from sources of ignition or oxidising agent.
- c) Acid must be kept away from substances with which they may react, producing dangerous compound.
- d) Strong corrosive agent must be kept away from gas cylinders or other containers.
- e) Pressurized aerosol cans must be collected separately in a single, suitable marked container

4.3.6.4.2.3 Drainage

- a) Scheduled waste storage area shall be isolated from any drainage system.
- b) Each of the cell shall be provided with individual pit to collect any potential spillage. The spillage shall be emptied out from the pit and removed as scheduled waste.

4.3.6.4.2.4 Waste Spillage Containment

- a) Containment of the spill from waste storage area should be constructed with materials appropriate for the wastes being contained

	ADDITIONAL INFORMATION TO THE DEIA REFINERY AND PETROCHEMICAL INTEGRATED DEVELOPMENT (RAPID) PROJECT, PENERANG JOHOR, 2012 TO INCLUDE EURO 5 MOGAS AND OLEFIN TANK UNITS	
	CHAPTER 4 POTENTIAL ENVIRONMENTAL IMPACT AND MITIGATION MEASURES	



and adequate to prevent loss to the environment and this include the types of paving to prevent seepage into groundwater and soil.

- b) The design philosophy of the Refinery and Cracker Complex waste storage area has include the bunding to contain 110% of potential total spillage. All spillage within the specific type of wastes storage area will be directed and contain in a pit separated from any drainage network and pits is to be emptied out as scheduled waste by the licensed contractor.

4.3.6.4.2.5 Packaging and Labelling.



The mitigation measures proposed to minimise the impacts to the environment from waste management during the operations phase in terms of packaging and labelling practices is provided below:

- a) An appropriate container should be selected according to the characteristics of the scheduled wastes. The characteristic of scheduled wastes shall be compatible with the type of material used for the container to prevent any reaction which will deteriorate the container.
- b) The container used should be in good condition (free from any damage such as tear or hole).
- c) For identification and warning purposes, containers of scheduled wastes shall be clearly labelled in accordance with the Third Schedule of the Environmental Quality (Scheduled Wastes) Regulations 2005 and marked with the scheduled wastes code as specified in the First Schedule of the Environmental Quality (Scheduled Wastes) Regulations 2005.

	<p>ADDITIONAL INFORMATION TO THE DEIA REFINERY AND PETROCHEMICAL INTEGRATED DEVELOPMENT (RAPID) PROJECT, PENERANG JOHOR, 2012 TO INCLUDE EURO 5 MOGAS AND OLEFIN TANK UNITS</p>	
	<p>CHAPTER 4 POTENTIAL ENVIRONMENTAL IMPACT AND MITIGATION MEASURES</p>	

4.3.6.4.2.6 Surveillance Monitoring.

Groundwater and soil monitoring should be conducted periodically at the individual units to ensure that no contamination of groundwater has occurred during the operations of the plant.

	<p style="text-align: center;">ADDITIONAL INFORMATION TO THE DEIA REFINERY AND PETROCHEMICAL INTEGRATED DEVELOPMENT (RAPID) PROJECT, PENGERANG JOHOR, 2012 TO INCLUDE EURO 5 MOGAS AND OLEFIN TANK UNITS</p>	
	<p style="text-align: center;">CHAPTER 4 POTENTIAL ENVIRONMENTAL IMPACT AND MITIGATION MEASURES</p>	

4.3.7 CHEMICAL MANAGEMENT AND HANDLING STUDY

The operational phase of the Refinery Cracker Complex will involve the use of various chemicals for the operations of the process units, utility systems as well as during regular maintenance and plant start-up/ shutdown and turnaround. The typical use of chemicals may include but is not limited to the following:



- a) Chemicals used for equipment maintenance such as solvents, oils, fuel and paints; and
- b) Chemicals utilised in chemical injection packages to enhance the processes.

4.3.7.1 Management of chemicals

The objective of the Chemical Handling Study is to present the chemical management philosophy for the Refinery Cracker Complex which include the storage and handling of chemicals at the Centralized Chemical Warehouse and distribution of the chemicals to the satellite storage areas within the petrochemical plants prior to usage.

RAPID Complex operating philosophy is such that all of the chemicals delivered via bulk container by trucks/land transportation for use in the Refinery and Cracker Complex is to be delivered and managed at the common chemical warehouse, which location is as indicated in **Figure 4-14**. All of the chemicals delivered via the vessel/marine transportation shall be piped from the terminal into the chemical tanks located in the petrochemical plant tank farm area.

The propose common chemical warehouse storage shall be design to store and segregated chemicals according to the types of chemical and their reactivity with each other. Chemicals shall be segregated based on the reactivity to prevent them from reacting with each other causing safety and health concerns.

	<p style="text-align: center;">ADDITIONAL INFORMATION TO THE DEIA REFINERY AND PETROCHEMICAL INTEGRATED DEVELOPMENT (RAPID) PROJECT, PENGERANG JOHOR, 2012 TO INCLUDE EURO 5 MOGAS AND OLEFIN TANK UNITS</p>	
	<p style="text-align: center;">CHAPTER 4 POTENTIAL ENVIRONMENTAL IMPACT AND MITIGATION MEASURES</p>	

Material Safety Data Sheets (MSDS) shall be provided for all chemicals in accordance with the requirements of Occupational Safety and Health (Classification, Packaging and Labelling of Hazardous Chemicals) Regulations, 2013 (CLASS).

RAPID Project chemical segregation philosophy is guided by the PETRONAS policy and in its technical standards and the proposed layout of the Common Chemical Warehouse is as in **Figure 4-15**.

4.3.7.2 Assumption and Limitations

The assumptions and limitations in the development of the Chemical Handling Study in this report are :

- a) The study assesses the potential impacts of chemical management and handling from the chemical warehouse and the petrochemical plant areas to the environment. This study does not include an assessment of impacts from these chemicals to human health and surrounding communities;
- b) Impacts on the handling and management of the chemical spillage and leakage where usage of chemical packages within each of the process units will not be covered under this section. This is due to all areas where identified to have potential spillage or leakages of chemicals will either be contained and managed as scheduled waste or routed for treatment at the Centralised Effluent Treatment Plant, depending on the toxicity of the chemicals.
- c) Spent chemicals are classified as scheduled waste and therefore, shall be managed in accordance to the Environmental Quality (Scheduled Waste) Regulations, 2005.

CHAPTER 4
POTENTIAL ENVIRONMENTAL IMPACT AND MITIGATION MEASURES

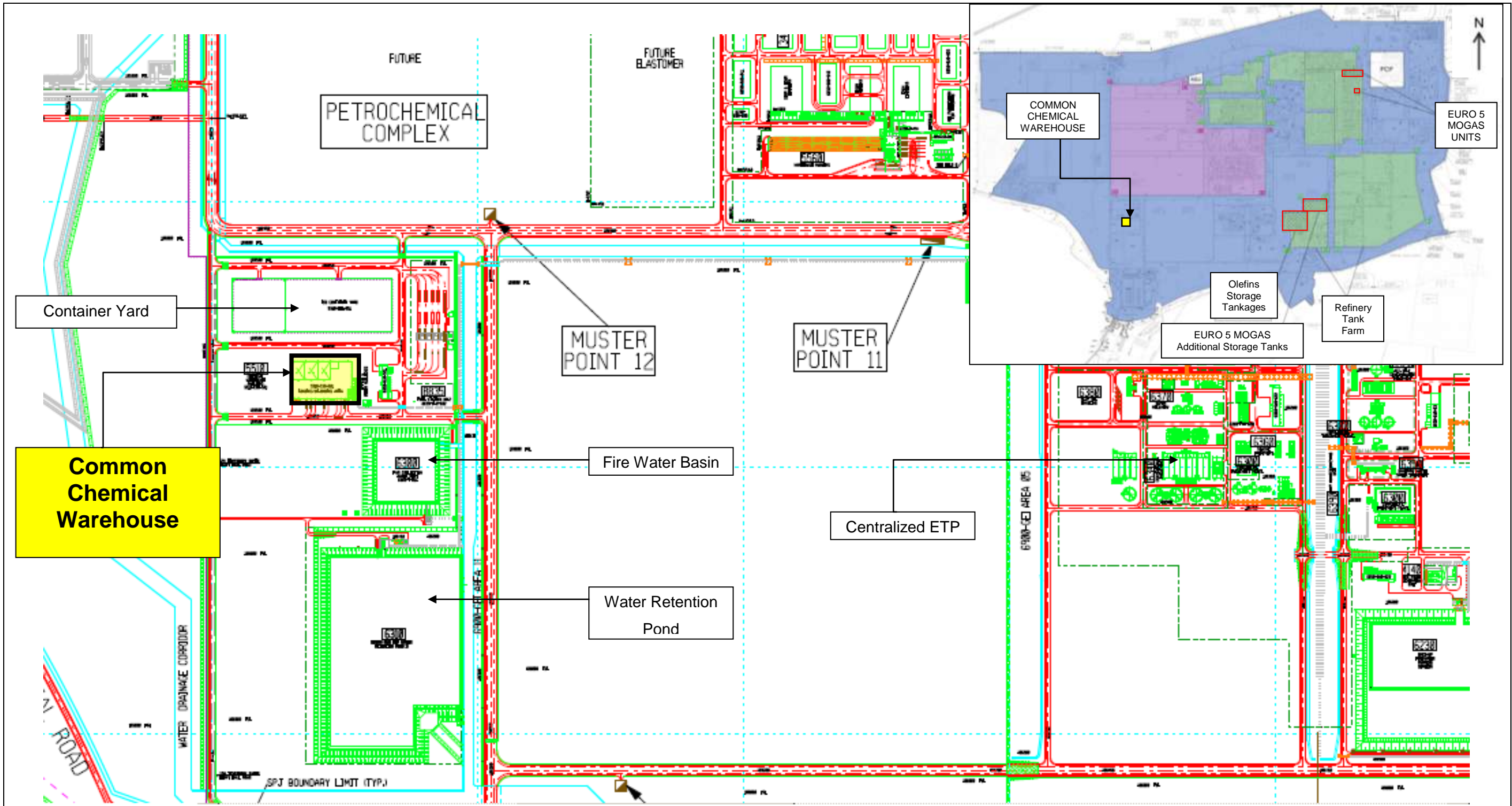


Figure 4-14: Common Chemical Storage Warehouse Location Within RAPID Plot Plan Layout.

CHAPTER 4
POTENTIAL ENVIRONMENTAL IMPACT AND MITIGATION MEASURES

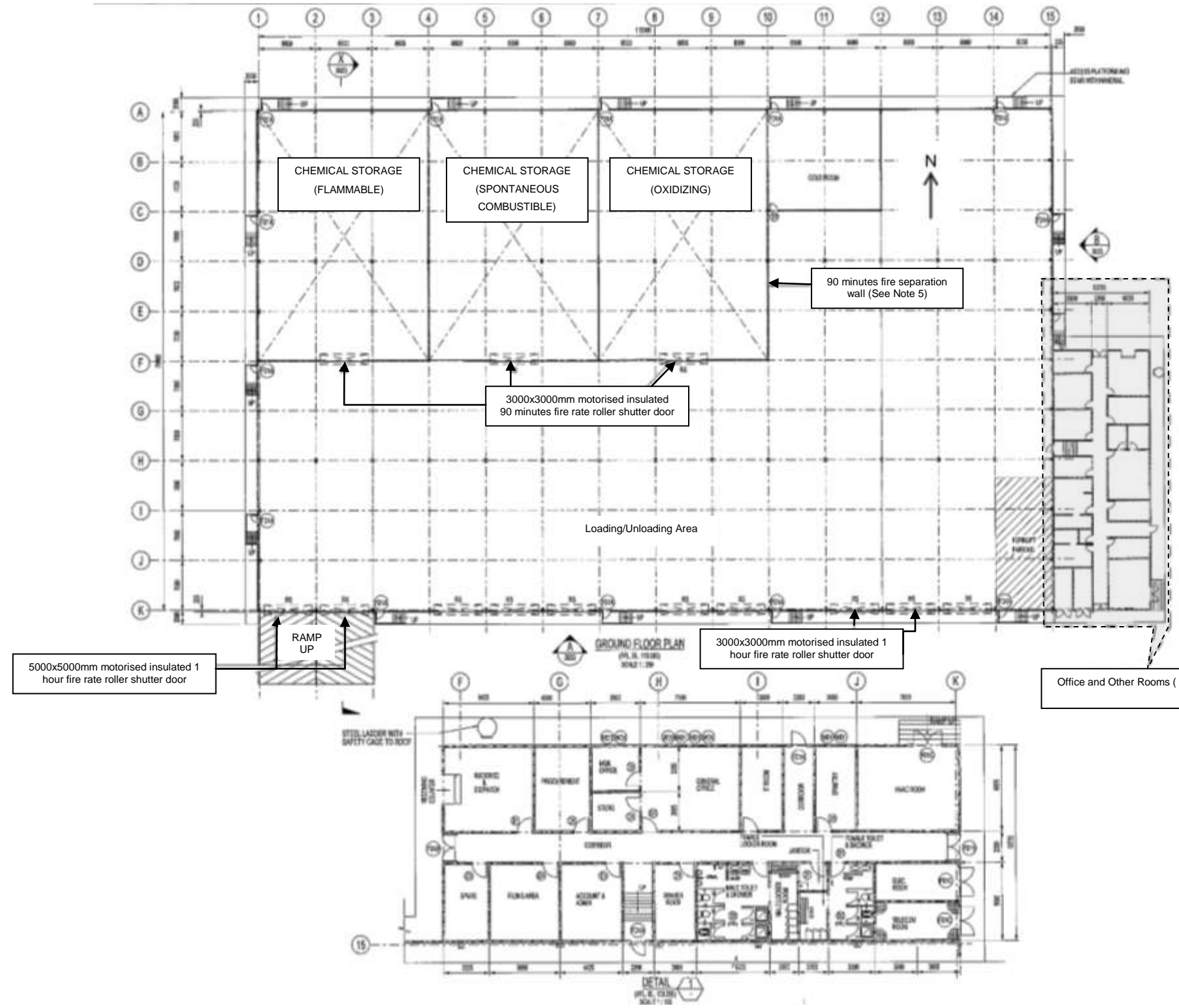




Figure 4-15 Proposed Layout of the Common Chemical Storage Warehouse

	ADDITIONAL INFORMATION TO THE DEIA REFINERY AND PETROCHEMICAL INTEGRATED DEVELOPMENT (RAPID) PROJECT, PENERANG JOHOR, 2012 TO INCLUDE EURO 5 MOGAS AND OLEFIN TANK UNITS	
	CHAPTER 4 POTENTIAL ENVIRONMENTAL IMPACT AND MITIGATION MEASURES	

The chemical types and their reactivity that determine the design of the separate cells in the chemical warehouse are :

- a) Toxicants (In the event of a fire these can contaminate firefighting water):
 - Separate from other flammable products and aerosols
 - Segregate oxidising agents and corrosives
 - Segregate flammable from non-flammable toxicants



- b) Aerosols (These can explode in a fire, thereby increasing the danger to fire fighters and the risk of fire spread)
 - Separate from toxicants and flammables
 - Segregate oxidising agents and corrosives

- c) Flammables (These will not normally contaminate firefighting water if they are non-toxic but by definition will greatly increase the risk of a toxicant fire if stored in the same area as toxicants)
 - Separate from toxicants and aerosols
 - Segregate oxidising agents and corrosives

- d) Oxidising Agents (These can react violently with other products stored in the warehouse)
 - Segregate from toxicants, aerosols, flammables and corrosives

- e) Corrosives (Leakage from packages containing corrosives can damage other packages with potentially hazardous consequences)
 - Segregate from toxicants, aerosols, flammables and oxidising agents

- f) Combustibles (These generally constitute low fire risk and reactivity hazards. They can therefore be used to enhance segregation, e.g. to provide a barrier between other groups of products which require segregation)

	<p style="text-align: center;">ADDITIONAL INFORMATION TO THE DEIA REFINERY AND PETROCHEMICAL INTEGRATED DEVELOPMENT (RAPID) PROJECT, PENGERANG JOHOR, 2012 TO INCLUDE EURO 5 MOGAS AND OLEFIN TANK UNITS</p>	
	<p style="text-align: center;">CHAPTER 4 POTENTIAL ENVIRONMENTAL IMPACT AND MITIGATION MEASURES</p>	

4.3.7.3 Chemical/ Hazardous Waste Disposal

Spent chemical at each of the petrochemical plants shall be treated as scheduled waste and to be stored at the scheduled waste storage area as described in **VOLUME 2, Appendix 5A**. The waste is to be disposed by a licensed scheduled waste operator.

4.3.7.4 Spills Stream Drainage

In RAPID, the drainage design philosophy is developed to cater for the following spillage and leak scenario:

- Chemicals that are defined as very toxic or toxic based on MSDS specification, either to physical and biological environment or the biological treatment in the effluent treatment plant, shall be fully contained in sump or pit. The collection sumps or pits are not to be connected to any drainage network in RAPID complex or find its way to the surrounding water bodies.
- Chemicals which are defined as non- toxic shall be connected to the Accidentally Chemical Containment Drainage (ACC) routed to the Centralized Effluent Treatment Plant for treatment.

At the centralized Chemical Warehouse, design of the chemical storage area is such a way that the spillage within the specific type of chemical storage area will be directed and contain in a pit to be removed as scheduled waste by licensed contractor and any spillage from different storage cell cannot be mixed due to chemical reactivity and safety requirement.

Chemical list for chemicals utilised at EURO 5 MOGAS Units and Olefins Storage Tankages have been developed and shown in **Table 4-58** and **Table 4-59**. The chemical list provide information on the key hazards, characteristics/ appearance, toxicity and ecology as well as the chemical incompatibility of chemicals utilised.

Table 4-58: EURO 5 MOGAS Unit Chemical Inventory

No	Name of Chemical	Appearance	Characteristics	Health Effect	Ecological effects
1	PROPANE	Colorless liquid under pressure. Faint hydrocarbon odor unless odorant is added.	Toxic, Flammable	May cause damage to nervous system and heart	Water quality standards and physical properties affecting water contamination potential. Toxicity to aquatic organisms.
2	ISOBUTANE	Colorless liquid under pressure. Faint hydrocarbon odor unless odorant is added.	Toxic, Flammable	May cause damage to central nervous system	No known significant effects or critical hazards
3	n-BUTANE	Colorless liquid under pressure. Faint hydrocarbon odor unless odorant is added.	Toxic, Flammable	Acute Toxicity	No known significant effects or critical hazards
4	n-PENTANE	Clear, Colorless liquid with sweet petroleum odor.	Toxic, Flammable	Acute oral toxicity	Toxic to aquatic life
5	METHANOL	Clear, Colorless, Flammable, Poisonous liquid, Pungent odor	Toxic, Flammable	Irritation in case of skin or eye contact, hazardous if inhaled. Can cause damage to human organs	Toxic to aquatic life. Biodegrades easily in water
6	N-HEPTANE	Colorless watery liquid with a gasoline-like odor	Toxic, Flammable	Irritation in case of skin or eye contact, hazardous if inhaled or ingested	Toxic to aquatic life.
7	1-DECENE	Colorless watery liquid with a pleasant odor. Floats on water.	Toxic, Flammable	May cause skin dessication. May cause fatality if ingested or inhaled	Very toxic to aquatic life with long lasting effects
8	DIMETHYL ETHER	Colorless. Liquid. (volatile, mobile liquid) Sweetish. Pungent. Ethereal	Flammable	May cause drowsiness or dizziness	No known significant effects or critical hazards
9	TERTIARY AMYL METHYL ETHER	Liquid, strong odour, colorless	Flammable	Irritation in case of skin or eye contact, hazardous if inhaled or ingested	No known significant effects or critical hazards
10	TERTIARY AMYL ALCOHOL	Liquid, pungent and unpleasant odor, colorless	Flammable	Irritation in case of skin or eye contact, hazardous if inhaled or ingested. Can cause damage to internal organs	No known significant effects or critical hazards

Table 4-59: Olefins Storage Tankages Chemical Inventory

No	Name of Chemical	Appearance	Characteristics	Health Effect	Ecological effects
1	TERTIARY BUTYL CATECHOL (TBC)	Colorless light yellow liquid with phenolic odor. Flammable liquid and vapor.	Flammable	Acute Toxicity	Highly toxic to fish
2	SODIUM HYPOCHLORITE	Green to Yellowish Liquid, odor chlorine-like	Non-Flammable, Toxic	Irritation in case of skin or eye contact, hazardous if inhaled or ingested	It is toxic to fish and aquatic organisms.